

## **Cisco Unified IP Phone 7906G and 7911G for Cisco Unified CallManager 5.0 (SIP)**

**INCLUDING LICENSE AND WARRANTY**

### **Corporate Headquarters**



Cisco Systems, Inc.  
170 West Tasman Drive  
San Jose, CA 95134-1706  
USA  
<http://www.cisco.com>  
Tel: 408 526-4000  
800 553-NETS (6387)  
Fax: 408 526-4100

OL-10379-01





## Common Phone Tasks

View online help on the phone	Press  and choose <b>Help</b> .
Place a call	Go off-hook before or after dialing a number.
Redial a number	Press <b>Redial</b> .
Talk using the handset and listen on the speaker	(Group Listen mode only.) Press <b>GListen</b> .
Listen on the speaker only	(Monitor mode only.) Press <b>Monitor</b> .
Use your call logs	Press  and select <b>Directories &gt; Missed Calls, Placed Calls, or Received Calls</b> . Select a number and press <b>Dial</b> .
Edit a number	Press <b>EditDial</b> , << or >>.
Hold/resume a call	Highlight a call to put on hold or resume from hold, and press  .
Transfer a call to a new number	Press <b>Transfer</b> , enter the number, then press <b>Transfer</b> again.
Start a standard conference call	Press <b>more &gt; Confrn</b> and dial the participant, then press <b>Confrn</b> again.



Cisco, Cisco IOS, Cisco Systems, and the Cisco Systems logo are registered trademarks of Cisco Systems, Inc. or its affiliates in the United States and certain other countries. All other brands, names, or trademarks mentioned in this document or Website are the property of their respective owners. The use of the word partner does not imply a partnership relationship between Cisco and any other company. (0501R)

© 2006 Cisco Systems, Inc. All rights reserved.

OL-10379-01



## Cisco Unified IP Phone 7906G and 7911G for Cisco Unified CallManager 5.0 (SIP)











Softkey Definitions  
Phone Screen Icons  
Button Icons  
Common Phone Tasks







## Softkey Definitions

<b>AbbrDial</b>	Dial using a speed-dial index number
<b>Answer</b>	Answer a call
<b>Barge</b>	Add yourself to a call on a shared line
<b>CallBack</b>	Receive notification when a busy extension becomes available
<b>Cancel</b>	Cancel an action or exit a screen without applying changes
<b>cBarge</b>	Add yourself to a call on a shared line and establish a conference
<b>CFwdALL</b>	Setup/cancel call forwarding
<b>Clear</b>	Delete records or settings
<b>Close</b>	Close the current window
<b>Conflist</b>	View conference participants
<b>Confrn</b>	Create a conference call
<b>Delete</b>	Remove characters to the right of the cursor when using <b>EditDial</b>
<b>Dial</b>	Dial a phone number
<b>DND</b>	Turn off Do Not Disturb (DND)
<b>EditDial</b>	Edit a number in a call log
<b>EndCall</b>	Disconnect the current call
<b>Erase</b>	Reset settings to their defaults
<b>Exit</b>	Return to the previous screen
<b>GListen</b>	Talk using the handset and listen on the speaker (Group Listen)
<b>GLOff</b>	Disable Group Listen
<b>GPickUp</b>	Answer a call ringing in another group
<b>iDivert</b>	Send a call to your voice messaging system





<b>MeetMe</b>	Host a Meet-Me conference call
<b>Monitor</b>	Listen to a call on the speaker
<b>MonOff</b>	Disable the Monitor function
<b>more</b>	Display additional softkeys
<b>Msgs</b>	Access voice mail system
<b>NewCall</b>	Make a new call
<b>OPickUp</b>	Answer a call ringing in an associated group
<b>Park</b>	Store a call using Call Park
<b>PickUp</b>	Answer a call in your group
<b>QRT</b>	Submit call problems to the system administrator
<b>Redial</b>	Redial the most recently dialed number
<b>Remove</b>	Remove a conference participant
<b>RmLstC</b>	Drop the last party added to a conference call
<b>Search</b>	Search for a directory listing
<b>Transfer</b>	Transfer a call
<b>Update</b>	Refresh content
<<	Delete entered characters
>>	Move through entered characters

## Phone Screen Icons

<b>Call State</b>	
	Call Forwarding enabled
	Call on hold
	Connected call
	Off-hook
	On-hook
	Incoming call
	Shared line in use
<b>Secure Calls</b>	
	Authenticated call
	Encrypted call
<b>Selected Device</b>	
	Handset in use
	Speaker in use (Monitor on)

<b>Other Features</b>	
	Speed Dial configured
	Message waiting
	Option selected
	Feature enabled
	Video enabled (Cisco Unified IP Phone 7911G only)
	URL entry in call log is ready to edit

## Button Icons

	Volume
	Navigation
	Hold
	Applications Menu



# Contents

---

## **Getting Started 1**

- Using this Guide 1
- Finding Additional Information 2
- Safety and Performance Information 2
  - Using an External Power Supply 10
  - Using External Devices 11
- Accessibility Features 11

## **Connecting Your Phone 12**

### **An Overview of Your Phone 16**

- Understanding Buttons and Hardware 16
- Understanding Applications Menus 18
- Understanding the Help System on Your Phone 18
- Understanding Lines vs. Calls 18
  - Understanding Line and Call Icons 19
- Understanding Feature Availability 19

### **Basic Call Handling 20**

- Placing a Call—Basic Options 20
- Placing a Call—Additional Options 21
- Answering a Call 22
- Ending a Call 23
- Using Hold and Resume 23
- Switching Between Multiple Calls 23
- Viewing Multiple Calls 24
- Transferring Calls 24
- Forwarding All Calls to Another Number 25

- Using Do Not Disturb 26
- Making Conference Calls 26
  - Understanding Types of Conference Calls 26
  - Starting and Joining a Standard Conference 27
  - Starting or Joining a Meet-Me Conference Call 28

## **Advanced Call Handling 29**

- Speed Dialing 29
- Picking Up a Redirected Call on Your Phone 30
- Using a Shared Line 31
  - Understanding Shared Lines 31
  - Adding Yourself to a Shared-Line Call 32
  - Preventing Others from Viewing or Barging a Shared-Line Call 33
- Storing and Retrieving Parked Calls 34
- Making and Receiving Secure Calls 34
- Using Cisco Extension Mobility 35

## **Using a Handset, Headset, and Speaker 37**

- Using the Group Listen Feature 37
- Using the Monitor Feature 38
- Using and Obtaining a Headset 38
- Using AutoAnswer 39

## **Using Phone Settings 40**

- Customizing Rings and Message Indicators 40
- Customizing the Phone Screen 41

## **Using Call Logs and Directories 42**

- Using Call Logs 42
- Directory Dialing 43
  - Using Corporate Directory on Your Phone 44
  - Using Personal Directory on Your Phone 45

**Accessing Voice Messages 48**

**Customizing Your Phone on the Web 49**

Accessing Your User Options Web Pages 49

Configuring Features and Services on the Web 50

    Using Personal Directory on the Web 50

        Using Your Personal Address Book on the Web 50

        Configuring Fast Dials on the Web 51

        Using the Address Book Synchronization Tool 52

    Setting Up Speed Dials on the Web 52

    Setting Up Phone Services on the Web 53

    Controlling User Settings on the Web 54

    Controlling Line Settings on the Web 55

    Using Cisco WebDialer 56

**Understanding Additional Configuration Options 59**

**Troubleshooting Your Phone 61**

General Troubleshooting 61

Viewing Phone Administration Data 62

Using the Quality Reporting Tool 62

**Cisco One-Year Limited Hardware Warranty Terms 63**

**Index 65**







# Getting Started

## Using this Guide

This guide provides you with an overview of the features available on your phone. You can read it completely for a solid understanding of your phone’s capabilities, or refer to the table below for pointers to commonly-used sections.

<b>If you want to...</b>	<b>Then...</b>
Explore your phone on your own	Press  and choose <b>Help</b> .
Review safety information	See the “Safety and Performance Information” section on page 2.
Connect your phone	See the “Connecting Your Phone” section on page 12.
Use your phone after it is installed	Start with the “An Overview of Your Phone” section on page 16.
Learn about the phone buttons	See the “Understanding Buttons and Hardware” section on page 16.
Make calls	See the “Placing a Call—Basic Options” section on page 20.
Put calls on hold	See the “Using Hold and Resume” section on page 23.
Transfer calls	See the “Transferring Calls” section on page 24.
Make conference calls	See the “Making Conference Calls” section on page 26.
Set up speed dialing	See the “Speed Dialing” section on page 29.
Share a phone number	See the “Using a Shared Line” section on page 31
Use the speaker on the phone	See the “Using a Handset, Headset, and Speaker” section on page 36.
Change the ring volume or tone	See the “Using Phone Settings” section on page 39.
View your missed calls	See the “Using Call Logs and Directories” section on page 41.
Listen to your voice messages	See the “Accessing Voice Messages” section on page 47.
See softkey and icon definitions	Refer to the Quick Reference Card in the front of this guide.

## Finding Additional Information

You can access the most current Cisco documentation on the World Wide Web at this URL:

<http://www.cisco.com/univercd/home/home.htm>

You can access the Cisco website at this URL:

<http://www.cisco.com/>

International Cisco websites can be accessed from this URL:

[http://www.cisco.com/public/countries\\_languages.shtml](http://www.cisco.com/public/countries_languages.shtml)

## Safety and Performance Information

Read the following safety notices before installing or using your Cisco Unified IP Phone:



**Warning**

---

### IMPORTANT SAFETY INSTRUCTIONS

**This warning symbol means danger. You are in a situation that could cause bodily injury. Before you work on any equipment, be aware of the hazards involved with electrical circuitry and be familiar with standard practices for preventing accidents. Use the statement number provided at the end of each warning to locate its translation in the translated safety warnings that accompanied this device.** Statement 1071

---

### SAVE THESE INSTRUCTIONS

**Waarschuwing**

### BELANGRIJKE VEILIGHEIDSINSTRUCTIES

**Dit waarschuwingssymbool betekent gevaar. U verkeert in een situatie die lichamelijk letsel kan veroorzaken. Voordat u aan enige apparatuur gaat werken, dient u zich bewust te zijn van de bij elektrische schakelingen betrokken risico's en dient u op de hoogte te zijn van de standaard praktijken om ongelukken te voorkomen. Gebruik het nummer van de verklaring onderaan de waarschuwing als u een vertaling van de waarschuwing die bij het apparaat wordt geleverd, wilt raadplegen.**

### BEWAAR DEZE INSTRUCTIES

**Varoitus TÄRKEITÄ TURVALLISUUSOHJEITA**

Tämä varoitusmerkki merkitsee vaaraa. Tilanne voi aiheuttaa ruumiillisia vammoja. Ennen kuin käsittelet laitteistoa, huomioi sähköpiirien käsittelyyn liittyvät riskit ja tutustu onnettomuuksien yleisiin ehkäisytapoihin. Turvallisuusvaroitusten käännökset löytyvät laitteen mukana toimitettujen käännettyjen turvallisuusvaroitusten joukosta varoitusten lopussa näkyvien lausuntonumeroiden avulla.

**SÄILYTÄ NÄMÄ OHJEET****Attention IMPORTANTES INFORMATIONS DE SÉCURITÉ**

Ce symbole d'avertissement indique un danger. Vous vous trouvez dans une situation pouvant entraîner des blessures ou des dommages corporels. Avant de travailler sur un équipement, soyez conscient des dangers liés aux circuits électriques et familiarisez-vous avec les procédures couramment utilisées pour éviter les accidents. Pour prendre connaissance des traductions des avertissements figurant dans les consignes de sécurité traduites qui accompagnent cet appareil, référez-vous au numéro de l'instruction situé à la fin de chaque avertissement.

**CONSERVEZ CES INFORMATIONS****Warnung WICHTIGE SICHERHEITSHINWEISE**

Dieses Warnsymbol bedeutet Gefahr. Sie befinden sich in einer Situation, die zu Verletzungen führen kann. Machen Sie sich vor der Arbeit mit Geräten mit den Gefahren elektrischer Schaltungen und den üblichen Verfahren zur Vorbeugung vor Unfällen vertraut. Suchen Sie mit der am Ende jeder Warnung angegebenen Anweisungsnummer nach der jeweiligen Übersetzung in den übersetzten Sicherheitshinweisen, die zusammen mit diesem Gerät ausgeliefert wurden.

**BEWAHREN SIE DIESE HINWEISE GUT AUF.**

**Avvertenza      IMPORTANTI ISTRUZIONI SULLA SICUREZZA**

**Questo simbolo di avvertenza indica un pericolo. La situazione potrebbe causare infortuni alle persone. Prima di intervenire su qualsiasi apparecchiatura, occorre essere al corrente dei pericoli relativi ai circuiti elettrici e conoscere le procedure standard per la prevenzione di incidenti. Utilizzare il numero di istruzione presente alla fine di ciascuna avvertenza per individuare le traduzioni delle avvertenze riportate in questo documento.**

**CONSERVARE QUESTE ISTRUZIONI**

**Advarsel      VIKTIGE SIKKERHETSINSTRUKSJONER**

**Dette advarselssymbolet betyr fare. Du er i en situasjon som kan føre til skade på person. Før du begynner å arbeide med noe av utstyret, må du være oppmerksom på farene forbundet med elektriske kretser, og kjenne til standardprosedyrer for å forhindre ulykker. Bruk nummeret i slutten av hver advarsel for å finne oversettelsen i de oversatte sikkerhetsadvarslene som fulgte med denne enheten.**

**TA VARE PÅ DISSE INSTRUKSJONENE**

**Aviso      INSTRUÇÕES IMPORTANTES DE SEGURANÇA**

**Este símbolo de aviso significa perigo. Você está em uma situação que poderá ser causadora de lesões corporais. Antes de iniciar a utilização de qualquer equipamento, tenha conhecimento dos perigos envolvidos no manuseio de circuitos elétricos e familiarize-se com as práticas habituais de prevenção de acidentes. Utilize o número da instrução fornecido ao final de cada aviso para localizar sua tradução nos avisos de segurança traduzidos que acompanham este dispositivo.**

**GUARDE ESTAS INSTRUÇÕES**

**¡Advertencia!      INSTRUCCIONES IMPORTANTES DE SEGURIDAD**

**Este símbolo de aviso indica peligro. Existe riesgo para su integridad física. Antes de manipular cualquier equipo, considere los riesgos de la corriente eléctrica y familiarícese con los procedimientos estándar de prevención de accidentes. Al final de cada advertencia encontrará el número que le ayudará a encontrar el texto traducido en el apartado de traducciones que acompaña a este dispositivo.**

**GUARDE ESTAS INSTRUCCIONES**

**Varning! VIKTIGA SÄKERHETSANVISNINGAR**

Denna varningssignal signalerar fara. Du befinner dig i en situation som kan leda till personskada. Innan du utför arbete på någon utrustning måste du vara medveten om farorna med elkretsar och känna till vanliga förfaranden för att förebygga olyckor. Använd det nummer som finns i slutet av varje varning för att hitta dess översättning i de översatta säkerhetsvarningar som medföljer denna anordning.

**SPARA DESSA ANVISNINGAR****Figyelem FONTOS BIZTONSÁGI ELOÍRÁSOK**

Ez a figyelmeztető jel veszélyre utal. Sérülésveszélyt rejtő helyzetben van. Mielőtt bármely berendezésen munkát végezte, legyen figyelemmel az elektromos áramkörök okozta kockázatokra, és ismerkedjen meg a szokásos balesetvédelmi eljárásokkal. A kiadványban szereplő figyelmeztetések fordítása a készülékhez mellékelt biztonsági figyelmeztetések között található; a fordítás az egyes figyelmeztetések végén látható szám alapján kereshető meg.

**ORIZZE MEG EZEKET AZ UTASÍTÁSOKAT!****Предупреждение ВАЖНЫЕ ИНСТРУКЦИИ ПО СОБЛЮДЕНИЮ ТЕХНИКИ БЕЗОПАСНОСТИ**

Этот символ предупреждения обозначает опасность. То есть имеет место ситуация, в которой следует опасаться телесных повреждений. Перед эксплуатацией оборудования выясните, каким опасностям может подвергаться пользователь при использовании электрических цепей, и ознакомьтесь с правилами техники безопасности для предотвращения возможных несчастных случаев. Воспользуйтесь номером заявления, приведенным в конце каждого предупреждения, чтобы найти его переведенный вариант в переводе предупреждений по безопасности, прилагаемом к данному устройству.

**СОХРАНИТЕ ЭТИ ИНСТРУКЦИИ**

**警告**      重要的安全性说明

此警告符号代表危险。您正处于可能受到严重伤害的工作环境中。在您使用设备开始工作之前，必须充分意识到触电的危险，并熟练掌握防止事故发生的标准工作程序。请根据每项警告结尾提供的声明号码来找到此设备的安全性警告说明的翻译文本。

请保存这些安全性说明

**警告**      安全上の重要な注意事項

「危険」の意味です。人身事故を予防するための注意事項が記述されています。装置の取り扱い作業を行うときは、電気回路の危険性に注意し、一般的な事故防止策に留意してください。警告の各国語版は、各注意事項の番号を基に、装置に付属の「Translated Safety Warnings」を参照してください。

これらの注意事項を保管しておいてください。

**주의**      중요 안전 지침

이 경고 기호는 위험을 나타냅니다. 작업자가 신체 부상을 일으킬 수 있는 위험한 환경에 있습니다. 장비에 작업을 수행하기 전에 전기 회로와 관련된 위험을 숙지하고 표준 작업 관례를 숙지하여 사고를 방지하십시오. 각 경고의 마지막 부분에 있는 경고문 번호를 참조하여 이 장치와 함께 제공되는 번역된 안전 경고문에서 해당 번역문을 찾으십시오.

이 지시 사항을 보관하십시오.

**Aviso**      **INSTRUÇÕES IMPORTANTES DE SEGURANÇA**

**Este símbolo de aviso significa perigo. Você se encontra em uma situação em que há risco de lesões corporais. Antes de trabalhar com qualquer equipamento, esteja ciente dos riscos que envolvem os circuitos elétricos e familiarize-se com as práticas padrão de prevenção de acidentes. Use o número da declaração fornecido ao final de cada aviso para localizar sua tradução nos avisos de segurança traduzidos que acompanham o dispositivo.**

**GUARDE ESTAS INSTRUÇÕES**

**Advarsel VIGTIGE SIKKERHEDSANVISNINGER**

Dette advarselssymbol betyder fare. Du befinder dig i en situation med risiko for legemeskade. Før du begynder arbejde på udstyr, skal du være opmærksom på de involverede risici, der er ved elektriske kredsløb, og du skal sætte dig ind i standardprocedurer til undgåelse af ulykker. Brug erklæringsnummeret efter hver advarsel for at finde oversættelsen i de oversatte advarsler, der fulgte med denne enhed.

**GEM DISSE ANVISNINGER**

تحذير

إرشادات الأمان الهامة

يوضح رمز التحذير هذا وجود خطر. وهذا يعني أنك متواجد في مكان قد ينتج عنه التعرض لإصابات. قبل بدء العمل، احذر مخاطر التعرض للصدمات الكهربائية وكن على علم بالإجراءات القياسية للحيلولة دون وقوع أي حوادث. استخدم رقم البيان الموجود في آخر كل تحذير لتحديد مكان ترجمته داخل تحذيرات الأمان المترجمة التي تأتي مع الجهاز. قم بحفظ هذه الإرشادات

**Upozorenje VAŽNE SIGURNOSNE NAPOMENE**

Ovaj simbol upozorenja predstavlja opasnost. Nalazite se u situaciji koja može prouzročiti tjelesne ozljede. Prije rada s bilo kojim uređajem, morate razumjeti opasnosti vezane uz električne sklopove, te biti upoznati sa standardnim načinima izbjegavanja nesreća. U prevedenim sigurnosnim upozorenjima, priloženima uz uređaj, možete prema broju koji se nalazi uz pojedino upozorenje pronaći i njegov prijevod.

**SAČUVAJTE OVE UPUTE****Upozornění DŮLEŽITÉ BEZPEČNOSTNÍ POKYNY**

Tento upozorňující symbol označuje nebezpečí. Jste v situaci, která by mohla způsobit nebezpečí úrazu. Před prací na jakémkoliv vybavení si uvědomte nebezpečí související s elektrickými obvody a seznamte se se standardními opatřeními pro předcházení úrazům. Podle čísla na konci každého upozornění vyhledejte jeho překlad v přeložených bezpečnostních upozorněních, která jsou přiložena k zařízení.

**USCHOVEJTE TYTO POKYNY**

Προειδοποίηση ΣΗΜΑΝΤΙΚΕΣ ΟΔΗΓΙΕΣ ΑΣΦΑΛΕΙΑΣ

Αυτό το προειδοποιητικό σύμβολο σημαίνει κίνδυνο. Βρίσκεστε σε κατάσταση που μπορεί να προκαλέσει τραυματισμό. Πριν εργαστείτε σε οποιοδήποτε εξοπλισμό, να έχετε υπόψη σας τους κινδύνους που σχετίζονται με τα ηλεκτρικά κυκλώματα και να έχετε εξοικειωθεί με τις συνήθεις πρακτικές για την αποφυγή ατυχημάτων. Χρησιμοποιήστε τον αριθμό δήλωσης που παρέχεται στο τέλος κάθε προειδοποίησης, για να εντοπίσετε τη μετάφρασή της στις μεταφρασμένες προειδοποιήσεις ασφαλείας που συνοδεύουν τη συσκευή.

ΦΥΛΑΞΤΕ ΑΥΤΕΣ ΤΙΣ ΟΔΗΓΙΕΣ

אזהרה

**הוראות בטיחות חשובות**

סימן אזהרה זה מסמל סכנה. אתה נמצא במצב העלול לגרום לפציעה. לפני שתעבוד עם ציוד כלשהו, עליך להיות מודע לסכנות הכרוכות במעגלים חשמליים ולהכיר את הנהלים המקובלים למניעת תאונות. השתמש במספר ההוראה המסופק בסופה של כל אזהרה כדי לאתר את התרגום באזהרות הבטיחות המתורגמות שמצורפות להתקן.

**שמור הוראות אלה**

Opomena

**ВАЖНИ БЕЗБЕДНОСНИ НАПАТСТВИЈА**

Симболот за предупредување значи опасност. Се наоѓате во ситуација што може да предизвика телесни повреди. Пред да работите со опремата, бидете свесни за ризикот што постои кај електричните кола и треба да ги познавате стандардните постапки за спречување на несреќни случаи. Искористете го бројот на изјавата што се наоѓа на крајот на секое предупредување за да го најдете неговиот период во преведените безбедносни предупредувања што се испорачани со уредот.

**ЧУВАЈТЕ ГИ ОВИЕ НАПАТСТВИЈА**



**Ostrzeżenie WAŻNE INSTRUKCJE DOTYCZĄCE BEZPIECZEŃSTWA**

Ten symbol ostrzeżenia oznacza niebezpieczeństwo. Zachodzi sytuacja, która może powodować obrażenia ciała. Przed przystąpieniem do prac przy urządzeniach należy zapoznać się z zagrożeniami związanymi z układami elektrycznymi oraz ze standardowymi środkami zapobiegania wypadkom. Na końcu każdego ostrzeżenia podano numer, na podstawie którego można odszukać tłumaczenie tego ostrzeżenia w dołączonym do urządzenia dokumencie z tłumaczeniami ostrzeżeń.

**NINIEJSZE INSTRUKCJE NALEŻY ZACHOWAĆ****Upozornenie DÔLEŽITÉ BEZPEČNOSTNÉ POKYNY**

Tento varovný symbol označuje nebezpečenstvo. Nachádzate sa v situácii s nebezpečenstvom úrazu. Pred prácou na akomkoľvek vybavení si uvedomte nebezpečenstvo súvisiace s elektrickými obvodmi a oboznámte sa so štandardnými opatreniami na predchádzanie úrazom. Podľa čísla na konci každého upozornenia vyhladajte jeho preklad v preložených bezpečnostných upozorneniach, ktoré sú priložené k zariadeniu.

**USCHOVAJTE SI TENTO NÁVOD****Warning**

---

**Read the installation instructions before you connect the system to its power source.**

---

**Warning**

---

**Ultimate disposal of this product should be handled according to all national laws and regulations.**

---

**Warning**

---

**Do not work on the system or connect or disconnect cables during periods of lightning activity.**

---

**Warning**

---

**To avoid electric shock, do not connect safety extra low voltage (SELV) circuits to telephone network voltage (TNV) circuits. LAN ports contain SELV circuits, and WAN ports contain TNV circuits. Some LAN and WAN ports use RJ-45 connectors. Use caution when connecting cables.**

---

**Caution**

---

Inline power circuits provide current through the communication cable. Use the Cisco provided cable or a minimum 24 AWG communication cable.

---

## Using an External Power Supply

The following warnings apply when you use the external power supply with the Cisco Unified IP Phone:

**Warning**

---

**This product relies on the building's installation for short-circuit (over current) protection. Ensure that a fuse or circuit breaker no larger than 120 VAC, 15A U.S. (240 VAC, 10A international) is used on the phase conductors (all current-carrying conductors).**

---

**Warning**

---

**The device is designed to work with TN power systems.**

---

**Warning**

---

**The plug-socket combination must be accessible at all times because it serves as the main disconnecting device.**

---

**Warning**

---

**The power supply must be placed indoors.**

---

**Caution**

---

Use only a Cisco specified power supply with this product.

---

### Power Outage

Your accessibility to emergency service through the phone is dependent on the phone being powered. If there is an interruption in the power supply, Service and Emergency Calling Service dialing will not function until power is restored. In the case of a power failure or disruption, you may need to reset or reconfigure equipment before using the Service or Emergency Calling Service dialing.

## Using External Devices

The following information applies when you use external devices with the Cisco Unified IP Phone:

Cisco recommends the use of good quality external devices (headsets) that are shielded against unwanted radio frequency (RF) and audio frequency (AF) signals.

Depending on the quality of these devices and their proximity to other devices such as mobile phones or two-way radios, some audio noise may still occur. In these cases, Cisco recommends that you take one or more of the following actions:

- Move the external device away from the source of the RF or AF signals.
- Route the external device cables away from the source of the RF or AF signals.
- Use shielded cables for the external device, or use cables with a better shield and connector.
- Shorten the length of the external device cable.
- Apply ferrites or other such devices on the cables for the external device.

Cisco cannot guarantee the performance of the system because Cisco has no control over the quality of external devices, cables, and connectors. The system will perform adequately when suitable devices are attached using good quality cables and connectors.



---

**Caution**

In European Union countries, use only headsets that are fully compliant with the EMC Directive [89/336/EC].

---

## Accessibility Features

A list of accessibility features is available upon request.

# Connecting Your Phone

Your system administrator will likely connect your new Cisco Unified IP Phone to the corporate IP telephony network. If that is not the case, refer to the graphics below to connect your phone.

The following graphic and table show how to connect the Cisco Unified IP Phone 7906G:

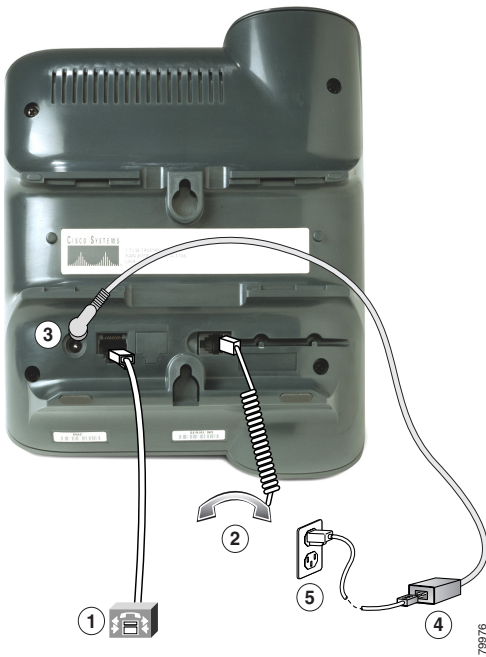

<b>1</b>	Network port (10/100 SW)	<b>4</b>	AC-to-DC power supply
<b>2</b>	Handset port	<b>5</b>	AC power cord
<b>3</b>	DC adapter port (DC48V)		

The following graphic and table show how to connect the Cisco Unified IP Phone 7911G:

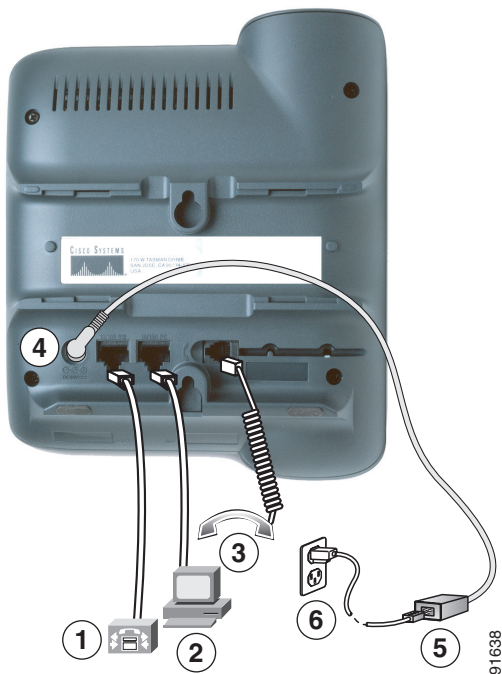

<b>1</b>	Network port (10/100 SW)	<b>4</b>	DC adapter port (DC48V)
<b>2</b>	Access port (10/100 PC)	<b>5</b>	AC-to-DC power supply
<b>3</b>	Handset port	<b>6</b>	AC power cord

## Adjusting the Handset Rest

When you connect your phone, you might want to adjust the handset rest to ensure that the receiver will not slip out of the cradle. See the table below for instructions.

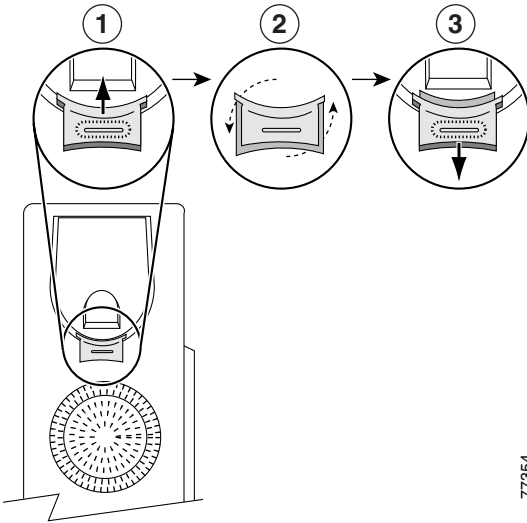

77354

1	Set the handset aside and pull the square plastic tab from the handset rest.
2	Rotate the tab 180 degrees.
3	Slide the tab back into the handset rest. An extension protrudes from the top of the rotated tab. Return the handset to the handset rest.

## Registering with TAPS

After your phone is connected to the network, your system administrator might ask you to auto-register your phone using the Tool for Auto-Registered Phones Support (TAPS). TAPS might be used either for a new phone or to replace an existing phone.

To register with TAPS, pick up the handset, enter the TAPS extension provided by your system administrator, and follow the voice prompts. You might need to enter your entire extension, including the area code. After your phone displays a confirmation message, hang up. The phone will restart.

## Headset Information

To use a headset, make sure the handset is disconnected, then connect the headset to the Handset port on the back of your phone.

Depending on headset manufacturer's recommendations, an external amplifier may be required. Refer to headset manufacturer's product documentation for more information.

Although Cisco Systems performs some internal testing of third-party headsets for use with the Cisco Unified IP Phones, Cisco does not certify or support products from headset or handset vendors. Because of the inherent environmental and hardware inconsistencies in the locations where Cisco Unified IP Phones are deployed, there is not a single “best” solution that is optimal for all environments. Cisco recommends that customers test the headsets that work best in their environment before deploying a large number of units in their network.

In some instances, the mechanics or electronics of various headsets can cause remote parties to hear an echo of their own voice when they speak to Cisco Unified IP Phone users.

Cisco Systems recommends the use of good quality external devices (headsets) that are screened against unwanted radio frequency (RF) and audio frequency (AF) signals. Depending on the quality of these devices and their proximity to other devices such as cell phones and two-way radios, some audio noise may still occur. See the “Using External Devices” section on page 11 for more information.

The primary reason that support of a headset would be inappropriate for the Cisco Unified IP Phone is the potential for an audible hum. This hum can either be heard by the remote party or by both the remote party and you, the Cisco Unified IP Phone user. Some potential humming or buzzing sounds can be caused by a range of outside sources, for example, electric lights, being near electric motors, large PC monitors. In some cases, a hum experienced by a user may be reduced or eliminated by using a local power cube. See the “Using an External Power Supply” section on page 10 for more information.

#### **Audio Quality Subjective to the User**

Beyond the physical, mechanical and technical performance, the audio portion of a headset must sound good to you (the user) and to the party on the far end. Sound is subjective and Cisco cannot guarantee the performance of any headsets or handsets, but some of the headsets and handsets on the sites listed below have been reported to perform well with Cisco Unified IP Phones.

Nevertheless, it is ultimately still the customer’s responsibility to test this equipment in their own environment to determine suitable performance.

For information about headsets, see:

<http://www.vxicorp.com/cisco>

<http://www.plantronics.com/cisco>

# An Overview of Your Phone

Cisco Unified IP Phone 7906G and 7911G are full-feature telephones that provide voice communication over the same data network that your computer uses, allowing you to place and receive calls, put calls on hold, transfer calls, make conference calls, and so on.

In addition to basic call-handling features, your Cisco Unified IP Phone 7906G and 7911G can provide specialized or advanced telephony features that extend your call-handling capabilities. Depending on configuration, your phone supports:

- Access to network data, XML applications, and web-based services.
- Online customizing of phone features and services from your User Options web pages.



## Understanding Buttons and Hardware

You can use this figure below to identify the buttons and hardware on your phone.





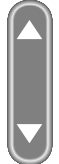

91031







	Item	Description	For more information, see...
1	Phone screen	Displays phone menus and call activity including caller ID, call duration, and call state.	“Understanding Applications Menus” section on page 18 and “Understanding Line and Call Icons” section on page 19.
2	Cisco Unified IP Phone series	Indicates your Cisco Unified IP Phone model series.	—
3	Softkey buttons	Each activates a softkey option displayed on your phone screen.	“Softkey Definitions” section on page 3.
4	Navigation button 	Allows you to scroll through menu items and highlight items. When the phone is on-hook, displays your Speed Dials.	“Understanding Applications Menus” section on page 18 and “Speed Dialing” section on page 29.
5	Applications Menu button 	Displays the Applications menu that provides access to a voice messaging system, phone logs and directories, settings, services, and help.	“Understanding Applications Menus” section on page 18.
6	Hold button 	Places the active call on hold, resumes a call on hold, and switches between an active call and a call on hold.	“Using Hold and Resume” section on page 23.
7	Keypad	Allows you to dial phone numbers, enter letters, and choose menu items.	“Basic Call Handling” section on page 20.
8	Volume button 	Controls the handset, headset, speaker, and ringer volume.	“Using a Handset, Headset, and Speaker” section on page 36.
9	Handset with light strip	The light strip on the handset indicates an incoming call or new voice message.	“Accessing Voice Messages” section on page 47.
10	Footstand	Allows the phone to stand at a convenient angle on a desk or table.	—

# Understanding Applications Menus

Use the Applications menus to access phone features.

If you want to...	Then...
Access the Applications menus	Press  to display a list of Applications: Messages, Directory, Settings, Services, and Help.
Scroll through a list or menu	Press  .
Select a menu item	Press  to highlight a menu item, then press <b>Select</b> .  You can also press the number on the keypad that corresponds to the number for the menu item.
Go back one level in a menu	Press <b>Exit</b> . (Note that if you press <b>Exit</b> from the top-level of a menu, the menu will close.)
Close a menu (and return to the Applications menu)	Press <b>Exit</b> one or more times until the menu closes, or press  .
Exit the Applications menu	Press  or <b>Exit</b> .



**Note** After you press , the LED turns green and stays lit while you are using the Applications menus. If you depart from an application without pressing  or **Exit** (for example, to answer a new call), the phone screen display may change but the  button stays green. If you press  again, the application that you were using resumes at the point when it was interrupted.

# Understanding the Help System on Your Phone

The Cisco Unified IP Phone 7906G and 7911G provide a comprehensive online help system. To view the phone help, press  and choose **Help**.









# Understanding Lines vs. Calls

To avoid confusion about lines and calls, refer to these descriptions:

- **Lines**—Each line corresponds to a phone number (or extension) that others can use to call you. Your phone can support one line.
- **Calls**—Each line can support multiple calls. By default, your phone supports up to six connected calls, but your system administrator can adjust this number according to your needs. Only one call can be active at any time; other calls are automatically placed on hold.

## Understanding Line and Call Icons

Your phone displays icons to help you determine the call and line state (on-hook, on hold, ringing, connected, and so on).

Icon	Call or line state	Description
	On-hook line	No call activity on this line.
	Off-hook line	You are dialing a number or an outgoing call is ringing.
	Connected call	You are connected to the other party.
	Ringing call	A call is ringing on your line.
	Call on hold	You have put this call on hold. See the “Using Hold and Resume” section on page 23.
	Remote-in-use	Another phone that shares your line has a connected call. See the “Understanding Shared Lines” section on page 31.
	Authenticated call	See the “Making and Receiving Secure Calls” section on page 34.
	Encrypted call	See the “Making and Receiving Secure Calls” section on page 34.

## Understanding Feature Availability

Depending on your phone system configuration, features included in this Phone Guide might not be available to you or might work differently on your phone. Contact your support desk or system administrator for information about feature operation or availability.

# Basic Call Handling

You can perform basic call-handling tasks using a range of features and services. Feature availability can vary; see your system administrator for more information.

## Placing a Call—Basic Options

Here are some easy ways to place a call on your Cisco Unified IP Phone.





If you want to...	Then...	For more information, see...
Place a call	Pick up the handset and dial the number.	“An Overview of Your Phone” section on page 16.
Dial on-hook (with dial tone)	Press <b>NewCall</b> and dial the number.	—
Redial a number	Press <b>Redial</b> .	—
Place a call when another call is active	<ol style="list-style-type: none"><li>1. Press <b>Hold</b>.</li><li>2. Press <b>New Call</b>.</li><li>3. Enter a number.</li></ol>	“Using Hold and Resume” section on page 23.
Dial from a call log	<ol style="list-style-type: none"><li>1. Press <b>Call Log</b> and select <b>Directories &gt; Missed Calls, Received Calls, or Placed Calls</b>.</li><li>2. Scroll to the number and press <b>Dial</b>.</li></ol>	“Using Call Logs” section on page 41.

### Tips

- You can dial on-hook without a dial tone (pre-dial). To pre-dial, enter a number, then go off-hook by lifting the handset and press **Dial**.
- When you pre-dial, your phone tries to anticipate the number you are dialing by displaying matching numbers (if available) from your Placed Calls log. This is called Auto Dial. To call a number displayed with Auto Dial, scroll to it, press **Dial**, and go off-hook.
- If you make a mistake while dialing, press **<<** to erase digits.

## Placing a Call—Additional Options

You can place calls using special features and services that might be available on your phone. See your system administrator for more information about these additional options.

If you want to...	Then...	For more information, see...
Speed dial a number	Do one of the following: <ul style="list-style-type: none"> <li>• Press , choose a speed-dial number, and press <b>Dial</b>.</li> <li>• Press  and select <b>Directories &gt; Speed Dials</b>. Select a number and press <b>Dial</b>.</li> <li>• Use the Abbreviated Dial feature.</li> <li>• Use the Fast Dial feature.</li> </ul>	“Speed Dialing” section on page 29.
Dial from a corporate directory on your phone	<ol style="list-style-type: none"> <li>1. Press  and select <b>Directories &gt; Corporate Directory</b> (name can vary).</li> <li>2. Enter a name and press <b>Search</b>.</li> <li>3. Highlight a listing and go off-hook.</li> </ol>	“Using Call Logs” section on page 41.
Dial from a corporate directory on your personal computer using Cisco WebDialer	<ol style="list-style-type: none"> <li>1. Open a web browser and go to a WebDialer-enabled corporate directory.</li> <li>2. Click the number that you want to dial.</li> </ol>	“Using Cisco WebDialer” section on page 55.
Use Cisco CallBack to receive notification when a busy or ringing extension is available	<ol style="list-style-type: none"> <li>1. Press <b>CallBack</b> while listening to the busy tone or ring sound.</li> <li>2. Hang up. Your phone alerts you when the line is free.</li> <li>3. Place the call again.</li> </ol>	Your system administrator.
Dial from a Personal Address Book (PAB) entry	<ol style="list-style-type: none"> <li>1. Press  and select <b>Directories &gt; Personal Directory</b> to log in.</li> <li>2. Choose <b>Personal Address Book</b> and search for a listing.</li> </ol>	“Using Personal Directory on Your Phone” section on page 44.

<b>If you want to...</b>	<b>Then...</b>	<b>For more information, see...</b>
Place a call using a billing or tracking code	<ol style="list-style-type: none"> <li>1. Dial a number.</li> <li>2. After the tone, enter a client matter code (CMC) or a forced authorization code (FAC).</li> </ol>	Your system administrator.
Place a call using your Cisco Extension Mobility profile	Log in to the Extension Mobility service on a phone.	“Using Cisco Extension Mobility” section on page 35.

## Answering a Call

You can answer a call by simply lifting the handset, or you can use other options if they are available on your phone.

<b>If you want to...</b>	<b>Then...</b>	<b>For more information, see...</b>
Switch from a connected call to answer a new call	Press <b>Answer</b> .	“Using Hold and Resume” section on page 23.
Answer a call using call waiting	Press <b>Answer</b> .	“Using Hold and Resume” section on page 23.
Send a call directly to your voice messaging system	Press <b>iDivert</b> .	“Accessing Voice Messages” section on page 47.
Auto-connect calls	Use <b>AutoAnswer</b> .	“Using AutoAnswer” section on page 38.
Retrieve a parked call on another phone	Use <b>Call Park</b> .	“Storing and Retrieving Parked Calls” section on page 33.
Use your phone to answer a call that is ringing elsewhere	Use <b>Call Pickup</b> .	“Picking Up a Redirected Call on Your Phone” section on page 30.



## Ending a Call

To end a call, simply hang up. Here are some more details.



If you want to...	Then...
Hang up while using the handset	Return the handset to its cradle. Or press <b>EndCall</b> .
Hang up while monitoring a call (using the speaker)	Press <b>EndCall</b> .
Hang up one call, but preserve another call on the same line	Press <b>EndCall</b> . If necessary, remove the call from hold first.

## Using Hold and Resume

Only one call can be active at any given time; all other connected calls must be placed on hold.

If you want to...	Then...
Put a call on hold	<ol style="list-style-type: none"> <li>1. Make sure the call you want to put on hold is highlighted.</li> <li>2. Press .</li> </ol>
Remove a call from hold	<ol style="list-style-type: none"> <li>1. Make sure the appropriate call is highlighted.</li> <li>2. Press .</li> </ol>

### Tips

- Engaging the Hold feature typically generates music or a beeping tone.
- A held call is indicated by the call-on-hold icon: . When a held call is highlighted, the Hold button  becomes lit (red). When a call that is not held is highlighted, and there are other held calls on the line, the Hold button changes to blinking (red).

## Switching Between Multiple Calls

You can switch between multiple calls on your phone.

If you want to...	Then...
Switch between connected calls	<ol style="list-style-type: none"> <li>1. Make sure the call that you want to switch to is highlighted.</li> <li>2. Press . Any active call is placed on hold and the selected call is resumed.</li> </ol>
Switch from a connected call to answer a ringing call	Press <b>Answer</b> . Any active call is placed on hold.

## Viewing Multiple Calls

Understanding how multiple calls are displayed on your phone can help you organize your call-handling efforts.

Your phone displays calls as follows for the highlighted line:

- Calls with the highest precedence and longest duration display at the top of the list.
- Calls of a similar type are grouped together. For example, calls that you have interacted with are grouped near the top, and calls on hold are grouped last.

## Transferring Calls

Transfer redirects a connected call. The *target* is the number to which you want to transfer the call.

If you want to...	Then...
Transfer a call without talking to the transfer recipient	<ol style="list-style-type: none"><li>1. From an active call, press <b>Transfer</b>.</li><li>2. Enter the target number.</li><li>3. Press <b>Transfer</b> again to complete the transfer or <b>EndCall</b> to cancel.</li></ol> <p><b>Note</b> If your phone supports on-hook transfer, you can alternately complete the transfer by hanging up.</p>
Talk to the transfer recipient before transferring a call (consult transfer)	<ol style="list-style-type: none"><li>1. From an active call, press <b>Transfer</b>.</li><li>2. Enter the target number.</li><li>3. Wait for the transfer recipient to answer.</li><li>4. Press <b>Transfer</b> again to complete the transfer or <b>EndCall</b> to cancel.</li></ol> <p><b>Note</b> If your phone supports on-hook transfer, you can alternately complete the transfer by hanging up.</p>
Redirect a call to your voice messaging system	Press <b>iDivert</b> . The call is automatically transferred to your voice message greeting. You can use iDivert with a call that is active, ringing, or on hold.



### Tips

- If on-hook transfer is enabled on your phone, you can either hang up to complete the call, or press **Transfer** and then hang up.
- If on-hook transfer is *not* enabled on your phone, hanging up without pressing **Transfer** again places the call on hold.
- You cannot use **Transfer** to redirect a call on hold. Press **Ⓞ** again to remove the call from hold before transferring it.



## Forwarding All Calls to Another Number

You can use Call Forward All to redirect incoming calls from your phone to another number.



If you want to...	Then...
Set up call forwarding on your line	Press <b>CFwdALL</b> and enter a target phone number.
Cancel call forwarding on your line	Press <b>CFwdALL</b> .
Verify that call forwarding is enabled on your line	Look for: <ul style="list-style-type: none"> <li>• Alternating call forwarding icons   displayed next to your phone number.</li> <li>• The call forward target number in the status line.</li> </ul>
Set up or cancel call forwarding remotely	<ol style="list-style-type: none"> <li>1. Log in to your User Options web pages. (See the “Accessing Your User Options Web Pages” section on page 48.)</li> <li>2. Access your call forwarding settings. (See the “Controlling Line Settings on the Web” section on page 54.)</li> </ol>

### Tips

- Enter the call forward target number exactly as you would dial it from your phone. For example, enter an access code or the area code, if necessary.
- You can forward your calls to a traditional analog phone or to another IP phone, although your system administrator might restrict the call forwarding feature to numbers within your company.
- Call forwarding is phone line specific. If a call reaches you on a line where call forwarding is not enabled, the call will ring as usual.
- Your system administrator can change call forwarding conditions for your phone line.

## Using Do Not Disturb

You can use the Do Not Disturb (DND) feature to block incoming calls on your phone with a busy tone.

If you want to...	Then...
Turn on DND	<ol style="list-style-type: none"><li data-bbox="491 329 1202 386">1. Press  and select <b>Settings &gt; Device Configuration &gt; Call Preferences &gt; Do Not Disturb</b>.</li><li data-bbox="491 402 1202 496">2. Select <b>Yes</b>, and then press <b>Save</b>. “Do Not Disturb” displays on the status line, and a DND softkey is added.</li></ol>
Turn off DND	Press the <b>DND</b> softkey, or: <ol style="list-style-type: none"><li data-bbox="491 557 1202 613">1. Press  and select <b>Settings &gt; Device Configuration &gt; Call Preferences &gt; Do Not Disturb</b>.</li><li data-bbox="491 630 1202 649">2. Select <b>No</b>, and then press <b>Save</b>.</li></ol>

### Tips

- When DND is turned on, received calls are not logged to the Missed Calls directory on your phone.
- When DND and Call Forward All are both enabled on your phone, Call Forward All takes precedence on incoming calls. That is, calls will be forwarded and the caller will not hear a busy tone.
- If DND is not enabled on your phone, see your system administrator.

## Making Conference Calls

Your Cisco Unified IP Phone allows you to join three or more people into one telephone conversation, creating a conference call.

## Understanding Types of Conference Calls

There are two types of conference calls: Standard and Meet-Me.

## Standard Conference Calls

You can create a standard conference in different ways, depending on your needs and the softkeys available on your phone:

- **Confrn**—Use this softkey to establish a standard conference by calling each participant. Standard conference calling is a default feature available on most phones.
- **cBarge**—Use this softkey to add yourself to an existing call on a shared line and to turn the call into a standard conference call. This feature is available only on phones that use shared lines.

See the “Starting and Joining a Standard Conference” section on page 27 for additional instructions.

## Meet-Me Conference Calls

You can create a Meet-Me conference by calling the Meet-Me phone number at a specified time.

See the “Starting or Joining a Meet-Me Conference Call” section on page 28 for additional instructions.

## Starting and Joining a Standard Conference

A standard conference allows at least three participants to talk on a single call.

If you want to...	Then...
<ul style="list-style-type: none"> <li>• Create a conference by calling participants</li> <li>• Add new participants to an existing conference</li> </ul>	<ol style="list-style-type: none"> <li>1. From a connected call, press <b>Confrn</b>. (You may need to press the <b>more</b> softkey to see <b>Confrn</b>.)</li> <li>2. Enter the participant’s phone number.</li> <li>3. Wait for the call to connect.</li> <li>4. Press <b>Confrn</b> again to add the participant to your call.</li> <li>5. Repeat to add additional participants.</li> </ol>
Participate in a conference	Answer the phone when it rings.
Create a conference by barging a called on shared line	Highlight a call on a shared line and press <b>cBarge</b> . (You may need to press the <b>more</b> softkey to display <b>cBarge</b> .) See the “Using a Shared Line” section on page 31.
View a list of conference participants	<ol style="list-style-type: none"> <li>1. Highlight an active conference.</li> <li>2. Press <b>ConfList</b>.</li> </ol> <p>Participants are listed in the order in which they join the conference with the most recent additions at the top.</p>
Get an updated list of participants	While viewing the conference list, press <b>Update</b> .
See who started the conference	While viewing the conference list, locate the person listed at the bottom of the list with an asterisk (*) next to the name.

<b>If you want to...</b>	<b>Then...</b>
Drop the last party added to the conference	Press <b>RmLstC</b> . You can remove participants only if you initiated the conference call.
Remove any conference participant	<ol style="list-style-type: none"> <li>1. Highlight the participant's name.</li> <li>2. Press <b>Remove</b>.</li> </ol> <p>You can remove participants only if you initiated the conference.</p>
End your participation in a conference	Hang up or press <b>EndCall</b> .

### Tips

- Calls must be on the same line before you can add them to a conference using **Confrn**.
- Depending on how your phone is configured, if you leave a conference after creating it, the conference might end. To avoid this, transfer the conference before hanging up.

## Starting or Joining a Meet-Me Conference Call

Meet-Me conferencing allows you to start or join a conference by dialing the conference number.

<b>If you want to...</b>	<b>Then...</b>
Start a Meet-Me conference	<ol style="list-style-type: none"> <li>1. Obtain a Meet-Me phone number from your system administrator.</li> <li>2. Distribute the number to participants.</li> <li>3. When you are ready to start the meeting, go off-hook to invoke a dial tone, then press <b>MeetMe</b>.</li> <li>4. Dial the Meet-Me conference number.</li> </ol> <p>Participants can now join the conference by dialing in.</p> <p><b>Note</b> Participants hear a busy tone if they call the conference before the initiator has joined. In this case, participants must call back.</p>
Participate in a Meet-Me conference	<p>Dial the Meet-Me conference number (provided by the conference initiator).</p> <p><b>Note</b> You will hear a busy tone if you call the conference before the initiator has joined. In this case, try your call again.</p>
End a Meet-Me conference	<p>All participants must hang up.</p> <p>The conference does not automatically end when the conference initiator disconnects.</p>

# Advanced Call Handling

Advanced call-handling tasks involve special features that your system administrator might configure for your phone depending on your call-handling needs and work environment.

## Speed Dialing



Speed dialing allows you to enter an index number or select a phone screen item to place a call. Depending on configuration, your phone can support several speed-dial features:

- Speed Dials
- Abbreviated Dialing
- Fast Dials



### Note

- To set up speed-dial numbers and Abbreviated Dial, you must be able to access your User Options web pages. See the “Customizing Your Phone on the Web” section on page 48.
- To set up Fast Dials, you must have access to the Personal Directory feature. See the “Using Personal Directory on Your Phone” section on page 44.
- Alternately, your system administrator can configure speed-dial features for you.

If you want to...	Then...
Use Speed Dials	<ol style="list-style-type: none"> <li>1. Set up speed-dial numbers. See the “Setting Up Speed Dials on the Web” section on page 51.</li> <li>2. To place a call, press , or press  and select <b>Directories &gt; Speed Dials</b>.</li> </ol>
Use Abbreviated Dial	<ol style="list-style-type: none"> <li>1. Set up Abbreviated Dialing codes. See the “Setting Up Speed Dials on the Web” section on page 51.</li> <li>2. To place a call, enter the Abbreviated Dialing code and press <b>AbbrDial</b>.</li> </ol>
Use Fast Dial	<ol style="list-style-type: none"> <li>1. Create a Personal Address Book entry and assign a Fast Dial code. See the “Using Personal Directory on the Web” section on page 49.</li> <li>2. To place a call, access the Fast Dial service on your phone. See the “Using Personal Directory on Your Phone” section on page 44.</li> </ol>

# Picking Up a Redirected Call on Your Phone

Call PickUp allows you to answer a call that is ringing on a co-worker's phone by redirecting the call to your phone. You might use Call PickUp if you share call-handling with coworkers.

If you want to...	Then...
Answer a call that is ringing on another extension within your call pickup group	<ol style="list-style-type: none"><li>1. Do one of the following:<ul style="list-style-type: none"><li>• If the <b>PickUp</b> softkey is available, press it.</li><li>• If the <b>PickUp</b> softkey is not available, go off-hook to display it, then press <b>PickUp</b>.</li></ul>If your phone supports auto-pickup, you are now connected to the call.</li><li>2. If the call rings, press <b>Answer</b> to connect to the call.</li></ol>
Answer a call that is ringing on another extension outside of your group	<ol style="list-style-type: none"><li>1. Do one of the following:<ul style="list-style-type: none"><li>• If the <b>GPickUp</b> softkey is available, press it.</li><li>• If the <b>GPickUp</b> softkey is not available, go off-hook to display it, then press <b>GPickUp</b>.</li></ul></li><li>2. Enter the group pickup code. If your phone supports auto-pickup, you are now connected to the call.</li><li>3. If the call rings, press <b>Answer</b> to connect to the call.</li></ol>
Answer a call that is ringing on another extension in your group or in an associated group	<ol style="list-style-type: none"><li>1. Do one of the following:<ul style="list-style-type: none"><li>• If the <b>OPickUp</b> softkey is available, press it.</li><li>• If the <b>OPickUp</b> softkey is not available, go off-hook to display it, then press <b>OPickUp</b>.</li></ul>If your phone supports auto-pickup, you are now connected to the call.</li><li>2. If the call rings, press <b>Answer</b> to connect to the call.</li></ol>

## Tips

- Pressing **PickUp** and **GPickUp** connects you to the call that has been ringing for the longest time.
- Pressing **OPickUp** connects you to the call in the pickup group with the highest priority.

## Using a Shared Line

Your system administrator might ask you to use a shared line if you:

- Have multiple phones and want one phone number
- Share call-handling tasks with coworkers
- Handle calls on behalf of a manager

## Understanding Shared Lines

### Remote-in-Use Icon

The remote-in-use icon  appears when another phone that shares your line has a connected call. You can place and receive calls as usual on the shared line, even when the remote-in-use icon appears.

### Sharing Call Information and Barging

Phones that share a line each display information about calls that are placed and received on the shared line. This information might include caller ID and call duration. (See the Privacy section for exceptions.)

When call information is visible in this way, you and coworkers who share a line can add yourselves to calls using either **Barge** or **cBarge**. See the “Adding Yourself to a Shared-Line Call” section on page 32.

### Privacy

If you do not want coworkers who share your line to see information about your calls, enable the Privacy feature. Doing so also prevents coworkers from barging your calls. See the “Preventing Others from Viewing or Barging a Shared-Line Call” section on page 33.



---

**Note**

The maximum number of calls that a shared line supports can vary by phone.

---

## Adding Yourself to a Shared-Line Call

Depending on how your phone is configured, you can add yourself to a call on a shared line using either Barge or cBarge.

If you want to...	Then...
See if the shared line is in use	Look for the remote-in-use icon  .
Add yourself to a call on a shared line using the <b>Barge</b> softkey	<ol style="list-style-type: none"><li>1. Highlight a remote-in-use call.</li><li>2. Press <b>Barge</b>. (You may need to press the <b>more</b> softkey to display <b>Barge</b>.) Other parties hear a beep tone announcing your presence.</li></ol>
Add yourself to a call on a shared line using the <b>cBarge</b> softkey	<ol style="list-style-type: none"><li>1. Highlight a remote-in-use call.</li><li>2. Press <b>cBarge</b>. (You may need to press the <b>more</b> softkey to display <b>cBarge</b>.) Other parties hear a tone and brief audio interruption, and call information changes on the phone screen.</li></ol>
Add new conference participants to a call that you have barged	Barge the call using <b>cBarge</b> , if available. Unlike <b>Barge</b> , <b>cBarge</b> converts the call into a standard conference call, allowing you to add new participants. See the “Making Conference Calls” section on page 26.
Leave a barged call	Hang up. If you hang up after using <b>Barge</b> , the remaining parties hear a disconnect tone and the original call continues. If you hang up after using <b>cBarge</b> , the call remains a conference call (provided at least three participants remain on the line).



### Tips

- If a phone that is using the shared line has Privacy enabled, call information and barge softkeys will not appear on the other phones that share the line.
- You will be disconnected from a call that you have joined using **Barge** if the call is put on hold, transferred, or turned into a conference call.



## Preventing Others from Viewing or Barging a Shared-Line Call

If you share a phone line, you can use the Privacy feature to prevent others who share the line from viewing or barging (adding themselves to) your calls.

If you want to...	Then...
Prevent others from viewing or barging calls on a shared line	<ol style="list-style-type: none"> <li>1. Press <b>more</b> &gt; <b>Private</b>.</li> <li>2. To verify that Privacy is on, look for the Privacy-enabled icon  next to “Private” on the phone screen.</li> </ol>
Allow others to view or barge calls on a shared line	<ol style="list-style-type: none"> <li>1. Press <b>more</b> &gt; <b>Private</b>.</li> <li>2. To verify that Privacy is off, look for the Privacy-disabled icon  next to “Private” on the phone screen.</li> </ol>

### Tips

- If the phone that shares your line has Privacy enabled, you can make and receive calls using the shared line as usual.
- The Privacy feature applies to all shared lines on your phone. Consequently, if you have multiple shared lines and Privacy is enabled, coworkers will not be able to view or barge calls on any of your shared lines.

## Storing and Retrieving Parked Calls

You can park a call when you want to store the call so that you or someone else can retrieve it from another phone in the Cisco Unified CallManager system (for example, a phone at a coworker’s desk or in a conference room).

If you want to...	Then...
Store an active call using Call Park	<ol style="list-style-type: none"> <li>1. During a call, press <b>Park</b>. (You may need to press the <b>more</b> softkey to see <b>Park</b>.)</li> <li>2. Record the call park number displayed on your phone screen.</li> <li>3. Hang up.</li> </ol>
Retrieve a parked call	Enter the call park number from any Cisco Unified IP Phone in your network to connect to the call.



### Note



You have a limited amount of time to retrieve a parked call before it reverts to ringing at the original number. See your system administrator for details.

# Making and Receiving Secure Calls

Depending on how your system administrator has configured your phone system, your phone might support making and receiving secure calls.

Your phone is capable of supporting these types of calls:

- *Authenticated* call—The identities of all phones participating in the call have been verified.
- *Encrypted* call—The phone is receiving and transmitting encrypted audio (your conversation) within the Cisco IP network. Encrypted calls are also authenticated.
- *Non-secure* call—At least one of the participating phones or the connection does not support these security features, or the phones cannot be verified.



If you want to...	Then...
Check the security level of a call	Look for a security icon in the top right corner of the call activity area, next to the call duration timer:  Authenticated call  Encrypted call Neither security icon appears if the call is non-secure.
Determine if secure calls can be made in your company	Contact your system administrator.



**Note** There are interactions, restrictions, and limitations that affect how security features work on your phone. For more information, ask your system administrator.

## Using Cisco Extension Mobility

Cisco Extension Mobility (EM) allows you to temporarily configure a Cisco Unified IP Phone as your own. Once you log in to EM, the phone adopts your user profile, including your phone lines, features, established services, and web-based settings. Your system administrator must configure EM for you.

If you want to...	Then...
Log in to EM	<ol style="list-style-type: none"> <li>1. Press  and choose <b>Services &gt; EM Service</b> (name can vary).</li> <li>2. Enter your user ID and PIN (provided by your system administrator).</li> <li>3. If prompted, select a device profile.</li> </ol>
Log out of EM	<ol style="list-style-type: none"> <li>1. Press  and choose <b>Services &gt; EM Service</b> (name can vary).</li> <li>2. When prompted to log out, press <b>Yes</b>.</li> </ol>

### Tips

- EM automatically logs you out after a certain amount of time. This time limit is established by your system administrator.
- Changes that you make to your EM profile (from the User Options web pages) take effect the next time that you log in to EM on a phone.
- Settings that are controlled on the phone only are not maintained in your EM profile.

# Using a Handset, Headset, and Speaker

The Cisco Unified IP Phone 7906G and 7911G provide a speaker for hands-free listening. You can use the speaker only to listen to a call. To talk on a call, you must use the handset.

You can use the speaker in one of two ways, depending on how your system administrator enables the phone. Your phone may be enabled for one of the following features, but not both at the same time:

- Group Listen
- Monitor (default)

## Using the Group Listen Feature

The following table shows how you can use the Group Listen feature.

If you want to...	Then...
Use the handset	Lift it to go off-hook; replace it to go on-hook.
Talk using the handset and listen on the speaker at the same time (Group Listen)	Press <b>GListen</b> . <b>Note</b> Group Listen must be enabled by your system administrator for the <b>GListen</b> softkey to display.
Turn off Group Listen and use the handset	Press <b>GLOff</b> .
Hang up after using Group Listen	Press <b>EndCall</b> or hang up.
Adjust the volume level for a call	<b>Note</b> When using Group Listen, adjusting the volume only changes the volume for the speaker and not the handset.  Press the up or down <b>Volume</b> button during a call or after invoking a dial tone.  Press <b>Save</b> to preserve the volume level for future calls.



**Note** If your system administrator has disabled the speaker on your phone, the **GListen**, **GLOff**, **Monitor**, and **MonOff** softkeys will not be available to you. You must lift the handset to place and monitor calls.

## Using the Monitor Feature

The following table shows how you can use the Monitor feature.

If you want to...	Then...
Use the handset	Lift it to go off-hook; replace it to go on-hook.
Listen to the call on the speaker	Press <b>Monitor</b> and then hang up the handset. You will be able to hear the call but you will not be able to talk on the call. <b>Note</b> The <b>Monitor</b> and <b>MonOff</b> softkeys are not available if Group Listen is enabled.
Turn off the speaker and use the handset	Lift the handset, or press <b>MonOff</b> . <b>Note</b> The <b>Monitor</b> and <b>MonOff</b> softkeys are not available if Group Listen is enabled.
Turn off the speaker and hang up	Press <b>EndCall</b> .
Adjust the speaker volume level for a call	Press the up or down <b>Volume</b> button during a call or after invoking a dial tone. Press <b>Save</b> to preserve the volume level for future calls.



### Note

If your system administrator has disabled the speaker on your phone, the **GListen**, **GLOff**, **Monitor**, and **MonOff** softkeys will not be available to you. You must lift the handset to place and monitor calls.



### Note

Pressing the **Volume** button changes the volume for the handset or speaker, depending on which device is in use. In Group Listen and Monitor modes, the volume adjustment is for the speaker and not the handset.

## Using and Obtaining a Headset

To use a headset, disconnect the handset and connect a headset to the Handset port.

For information about purchasing headsets, see the “Headset Information” section on page 14. Depending on headset manufacturer’s recommendations, an external amplifier may be required. Refer to headset manufacturer’s product documentation for more information.

## Using AutoAnswer

When AutoAnswer is enabled, your phone answers incoming calls automatically after a few rings. Your system administrator can configure AutoAnswer to use the speaker to answer calls. However, you can only monitor the call using the speaker. To speak to the caller, you must pick up the handset.

# Using Phone Settings

You can personalize your Cisco Unified IP Phone by adjusting the ring tone, background image, and other settings.

## Customizing Rings and Message Indicators

You can customize how your phone indicates an incoming call and a new voice message. You can also adjust the ringer volume for your phone.

If you want to...	Then...
Change the ring tone	<ol style="list-style-type: none"> <li>1. Press  and select <b>Settings &gt; User Preferences &gt; Rings</b>.</li> <li>2. Select a ring tone and press <b>Play</b> to hear a sample.</li> <li>3. Press <b>Save</b> to set the ring tone, or press <b>Cancel</b>.</li> </ol>
Change the ring pattern (flash-only, ring once, beep-only, etc.)	<ol style="list-style-type: none"> <li>1. Log in to your User Options web pages. (See the “Accessing Your User Options Web Pages” section on page 48.)</li> <li>2. Access your call ring pattern settings. (See the “Controlling Line Settings on the Web” section on page 54.)</li> </ol> <p><b>Note</b> Before you can access this setting, your system administrator might need to enable it for you.</p>
Adjust the volume level for the phone ringer	Press the Volume button while the handset is in the cradle. The new ringer volume is saved automatically.
Change the way that the voice message light on your handset works	<ol style="list-style-type: none"> <li>1. Log in to your User Options web pages. (See the “Accessing Your User Options Web Pages” section on page 48.)</li> <li>2. Access your message indicator settings. (See the “Controlling Line Settings on the Web” section on page 54.)</li> </ol> <p><b>Note</b> Typically, the default system policy is to indicate a new voice message by displaying a steady light on the handset light strip.</p>

# Customizing the Phone Screen

You can adjust the characteristics of the phone screen.

If you want to...	Then...
Change the background image	<ol style="list-style-type: none"><li data-bbox="397 334 1166 391">1. Press  and choose <b>Settings &gt; User Preferences &gt; Background Images</b>.</li><li data-bbox="397 407 1206 435">2. Scroll through available images and press <b>Select</b> to choose an image.</li><li data-bbox="397 451 1120 479">3. Press <b>Preview</b> to see a larger view of the background image.</li><li data-bbox="397 495 915 522">4. Press <b>Exit</b> to return to the selection menu.</li><li data-bbox="397 539 1032 566">5. Press <b>Save</b> to accept the new image, or press <b>Cancel</b>.</li></ol>
Change the language on the phone screen	<ol style="list-style-type: none"><li data-bbox="397 573 1188 630">1. Log in to your User Options web pages. (See the “Accessing Your User Options Web Pages” section on page 48.)</li><li data-bbox="397 646 1206 703">2. Access your user settings. (See the “Controlling User Settings on the Web” section on page 53.)</li></ol>
Change the line text label	<ol style="list-style-type: none"><li data-bbox="397 719 1188 776">1. Log in to your User Options web pages. (See the “Accessing Your User Options Web Pages” section on page 48.)</li><li data-bbox="397 792 1147 849">2. Access your line text label settings. (See the “Controlling Line Settings on the Web” section on page 54.)</li></ol>









# Using Call Logs and Directories

This section describes how you can use call logs and directories. To access both features, press  and select **Directories**.

## Using Call Logs

Your phone maintains logs of your missed, placed, and received calls.

If you want to...	Then...
View your call logs	Press  , and choose <b>Directories &gt; Missed Calls, Placed Calls, or Received Calls</b> . Each stores up to 100 records. To view a truncated listing, highlight it and press <b>EditDial</b> .
Erase your call logs	Press  , choose <b>Directories</b> , and press <b>Clear</b> . Doing so erases all records in all logs.
Dial from a call log (while not on another call)	<ol style="list-style-type: none"> <li>1. Press  and choose <b>Directories &gt; Missed Calls, Placed Calls, or Received Calls</b>.</li> <li>2. Highlight a call record from the log.</li> <li>3. If you need to edit the displayed number, press <b>EditDial</b> followed by &lt;&lt; or &gt;&gt;. To delete the number, press <b>EditDial</b> followed by <b>Delete</b>. (You may need to press the <b>more</b> softkey to display <b>Delete</b>.)</li> <li>4. Go off-hook to place the call.</li> </ol>

If you want to...	Then...
Dial from a call log (while connected to another call)	<ol style="list-style-type: none"> <li>1. Press , and choose <b>Directories &gt; Missed Calls, Placed Calls, or Received Calls</b>.</li> <li>2. Highlight a call record from the log.</li> <li>3. If you need to edit the displayed number, press <b>EditDial</b> followed by &lt;&lt; or &gt;&gt;. To delete the number, press <b>EditDial</b> followed by <b>Delete</b>. (You may need to press the <b>more</b> softkey to display <b>Delete</b>.)</li> <li>4. Press <b>Dial</b>.</li> <li>5. Choose one of the following to handle the original call: <ul style="list-style-type: none"> <li>• <b>Hold</b>—Puts the first call on hold.</li> <li>• <b>Transfer</b>—Transfers the first party to the second and drops you from the call. (Press <b>Transfer</b> again after dialing to complete the action.)</li> <li>• <b>Confrn</b>—Creates a conference call with all parties, including you. (Press <b>Confrn</b> again after dialing to complete the action.)</li> <li>• <b>End Call</b>—Disconnects the first call and dials the second.</li> </ul> </li> </ol>
Place a call from a URL entry in a call log	<ol style="list-style-type: none"> <li>1. Press , and choose <b>Directories &gt; Missed Calls, Placed Calls, or Received Calls</b>.</li> <li>2. Highlight the URL entry that you want to dial.</li> <li>3. If you need to edit the entry, press <b>EditDial</b>. The  icon appears to indicate that you can begin editing characters in the URL entry.</li> <li>4. Press <b>Dial</b>.</li> </ol>

## Directory Dialing

Depending on configuration, your phone can provide corporate and personal directory features:

- **Corporate Directory**—A directory of corporate contacts that is set up and maintained by your system administrator.
- **Personal Directory**—If available, personal contacts and associated speed-dial codes that you can configure and access from your phone and User Options web pages. Personal Directory comprises the Personal Address Book (PAB) and Fast Dials.
  - PAB is a directory of your personal contacts.
  - Fast Dials allows you to assign codes to PAB entries for quick dialing.

## Using Corporate Directory on Your Phone

You can use a corporate directory to place calls to coworkers.

If you want to...	Then...
Dial from a corporate directory (while not on another call)	<ol style="list-style-type: none"> <li>1. Press <b>Ⓧ</b>, and choose <b>Directories &gt; Corporate Directory</b> (exact name can vary).</li> <li>2. Use your keypad to enter a full or partial name and press <b>Search</b>.</li> <li>3. To dial, select the listing, and go off-hook.</li> </ol>
Dial from a corporate directory (while connected to another call)	<ol style="list-style-type: none"> <li>1. Press <b>Ⓧ</b>, and choose <b>Directories &gt; Corporate Directory</b> (exact name can vary).</li> <li>2. Use your keypad to enter a full or partial name, and press <b>Search</b>.</li> <li>3. Scroll to a listing and press <b>Dial</b>.</li> <li>4. Choose one of the following to handle the original call: <ul style="list-style-type: none"> <li>• <b>Hold</b>—Puts the first call on hold.</li> <li>• <b>Transfer</b>—Transfers the first party to the second and drops you from the call. (Press <b>Transfer</b> again after dialing to complete the action.)</li> <li>• <b>Confrn</b>—Creates a conference call with all parties, including you. (Press <b>Confrn</b> again after dialing to complete the action.)</li> <li>• <b>End Call</b>—Disconnects the first call and dials the second.</li> </ul> </li> </ol>

### Tip

Use the numbers on your keypad to enter characters on your phone screen. Use the Navigation button on your phone to move between input fields.

## Using Personal Directory on Your Phone

The Personal Directory feature set contains your Personal Address Book (PAB) and Fast Dial codes. This section describes how to set up and use Personal Directory on your phone. Alternately, see the “Using Personal Directory on the Web” section on page 49.

If you want to...	Then...
Access Personal Directory (for PAB and Fast Dial codes)	<ol style="list-style-type: none"><li>1. Press <b>⊕</b>, and choose <b>Directories &gt; Personal Directory</b> (exact name can vary).</li><li>2. Enter your Cisco Unified CallManager user ID and PIN, then press <b>Submit</b>.</li></ol>
Search for a PAB entry	<ol style="list-style-type: none"><li>1. Access Personal Directory, then choose <b>Personal Address Book</b>.</li><li>2. Enter search criteria and press <b>Submit</b>.</li><li>3. You can choose <b>Previous</b> or <b>Next</b> to move through listings.</li><li>4. Highlight the PAB listing that you want and press <b>Select</b>.</li></ol>
Dial from PAB entry	<ol style="list-style-type: none"><li>1. Search for a listing.</li><li>2. Highlight the listing and press <b>Select</b>.</li><li>3. Press <b>Dial</b>. (You may need to press the <b>more</b> softkey to see <b>Dial</b>.)</li><li>4. Enter the participant’s phone number.</li><li>5. Highlight the number that you want to dial and press <b>OK</b>.</li><li>6. Press <b>OK</b> again to dial the number.</li></ol>
Delete a PAB entry	<ol style="list-style-type: none"><li>1. Search for a listing.</li><li>2. Highlight the listing and press <b>Delete</b>.</li><li>3. Choose <b>OK</b> to confirm the deletion.</li></ol>
Edit a PAB entry	<ol style="list-style-type: none"><li>1. Search for a listing.</li><li>2. Highlight the listing and press <b>Edit</b> to modify a name or email address.</li><li>3. If necessary, choose <b>Phones</b> to modify a phone number.</li><li>4. Press <b>Update</b>.</li></ol>
Add a new PAB entry	<ol style="list-style-type: none"><li>1. Access Personal Directory, then choose <b>Personal Address Book</b>.</li><li>2. Access the Search page by choosing <b>Submit</b>. (You do not need to input search information first.)</li><li>3. Press <b>New</b>.</li><li>4. Use your phone keypad to enter a name and email information.</li><li>5. Choose <b>Phones</b> and use the keypad to enter phone numbers. Be sure to include any necessary access codes such as a 9 or 1.</li><li>6. Choose <b>Submit</b> to add the entry to the database.</li></ol>

If you want to...	Then...
Assign a Fast Dial code to a PAB entry	<ol style="list-style-type: none"> <li>1. Search for a PAB entry.</li> <li>2. Highlight the listing and press <b>Select</b>.</li> <li>3. Press <b>Fast Dial</b>.</li> <li>4. Highlight the number that you want to dial and press <b>Select</b>.</li> <li>5. Highlight the Fast Dial code that you want to assign to the number and press <b>Select</b>.</li> </ol>
Add a raw Fast Dial code (not using a PAB entry)	<ol style="list-style-type: none"> <li>1. Press <b>⊕</b>, and choose <b>Directories &gt; Personal Directory &gt; Personal Fast Dials</b>.</li> <li>2. Press <b>Fast Dial</b>.</li> <li>3. Highlight a Fast Dial code that is unassigned and press <b>Select</b>.</li> <li>4. Press <b>Assign</b>.</li> <li>5. Enter a phone number.</li> <li>6. Press <b>Update</b>.</li> </ol>
Search for Fast Dial codes	<ol style="list-style-type: none"> <li>1. Press <b>⊕</b>, and choose <b>Directories &gt; Personal Directory &gt; Personal Fast Dials</b>.</li> <li>2. You can choose <b>Previous</b> or <b>Next</b> to move through listings.</li> <li>3. Highlight the listing that you want and press <b>Select</b>.</li> </ol>
Place a call using a Fast Dial code	<ol style="list-style-type: none"> <li>1. Search for a Fast Dial code.</li> <li>2. Highlight the listing you want and press <b>Select</b>.</li> <li>3. Press <b>Dial</b>.</li> <li>4. Choose <b>OK</b> to complete the action.</li> </ol>
Delete a Fast Dial code	<ol style="list-style-type: none"> <li>1. Search for a Fast Dial code.</li> <li>2. Highlight the listing you want and press <b>Select</b>.</li> <li>3. Press <b>Remove</b>.</li> </ol>
Log out of Personal Directory	<ol style="list-style-type: none"> <li>1. Press <b>⊕</b>, and choose <b>Directories &gt; Personal Directory</b> (exact name can vary).</li> <li>2. Choose <b>Logout</b>.</li> </ol>

## **Tips**



- Your system administrator can provide you the user ID and PIN that you need to log in to Personal Directory.
- Personal Directory automatically logs you out after a certain amount of time. This time limit can vary. Ask your system administrator for more information.
- Use the numbers on your keypad to enter characters on your phone screen. Use the Navigation button on your phone to move between input fields.

# Accessing Voice Messages

To access voice messages, press , and select **Messages**.



**Note** Your company determines the voice message service that your phone system uses. For the most accurate and detailed information, refer to the documentation that came with your voice message service.

If you want to...	Then...
Set up and personalize your voice message service	Do one of the following: <ul style="list-style-type: none"> <li>• Press <b>Msgs</b> and follow the voice instructions.</li> <li>• Press , select <b>Messages</b>, and follow the voice instructions.</li> </ul>
See if you have a new voice message	Look for: <ul style="list-style-type: none"> <li>• A steady red light on your handset. (This indicator can vary. See the “Customizing Rings and Message Indicators” section on page 39.)</li> <li>• An envelope icon  on your phone screen.</li> </ul>
Listen to your voice messages or access the voice messages menu	Do one of the following: <ul style="list-style-type: none"> <li>• Press <b>Msgs</b> and follow the voice instructions.</li> <li>• Press , select <b>Messages</b>, and follow the voice instructions.</li> </ul>
Send a call to your voice message system	Press <b>iDivert</b> . The iDivert feature automatically transfers a call (including a ringing or held call) to your voice message system. Callers hear your voice message greeting and can leave you a message.

# Customizing Your Phone on the Web

---

Your Cisco Unified IP Phone is a network device that can share information with other network devices in your company, including your personal computer. You can use your computer to log in to your Cisco Unified CallManager User Options web pages, where you can control features, settings, and services for your Cisco Unified IP Phone. For example, you can set up speed-dial numbers from your User Options web pages.

## Accessing Your User Options Web Pages

This section describes how to log in and select a phone device.

If you want to...	Then do this...
Log in to your User Options web pages	<ol style="list-style-type: none"><li>1. Obtain a User Options URL, user ID, and default password from your system administrator.</li><li>2. Open a web browser on your computer, enter the URL, and log on.</li><li>3. If prompted to accept security settings, click <b>Yes</b> or <b>Install Certificate</b>. The Cisco Unified CallManager User Options main web page displays. From this page you can select <b>User Options</b> to access User Settings, Directory features, a Personal Address Book, and Fast Dials. Or, to access phone-specific options, select a device (see below).</li></ol>
Select a device after logging in	<ol style="list-style-type: none"><li>1. After you have logged in to your User Options pages, choose <b>User Options &gt; Device</b>. The Device Configuration page displays.</li><li>2. If you have multiple devices assigned to you, verify that the appropriate device (phone model or Extension Mobility profile) is selected. If necessary, choose another device from the Name drop-down menu. From the Device Configuration page, you can access all of the various configuration options available for your phone (other pages might not provide access to all options).<ul style="list-style-type: none"><li>– Choose <b>User Options</b> to access User Settings, Directory, Personal Address Book, and Fast Dials.</li><li>– Choose toolbar buttons to access phone-specific options, such as line settings, phone service settings, and speed dials.</li></ul>To return to the Device Configuration page from another page, choose <b>User Options &gt; Device</b>.</li></ol>



## Configuring Features and Services on the Web

The topics in this section describe how to configure features and services from your User Options web pages after logging in. See the “Accessing Your User Options Web Pages” section on page 48.

### Using Personal Directory on the Web

The Personal Directory feature set that you can access on your computer consists of:

- A Personal Address Book (PAB)
- Fast Dials
- Cisco Unified CallManager Address Book Synchronizer



**Note** You can also access PAB and Fast Dials from your phone. See the “Using Personal Directory on Your Phone” section on page 44.

### Using Your Personal Address Book on the Web

This section describes how to use your PAB from the User Options web pages.

If you want to...	Then do this after you log in...
Add a new PAB entry	<ol style="list-style-type: none"> <li>1. Choose <b>User Options &gt; Personal Address Book</b>.</li> <li>2. Choose <b>New</b>.</li> <li>3. Enter information for the entry.</li> <li>4. Click <b>Save</b>.</li> </ol>
Search for a PAB entry	<ol style="list-style-type: none"> <li>1. Choose <b>User Options &gt; Personal Address Book</b>.</li> <li>2. Specify search information and click <b>Find</b>.</li> </ol>
Edit a PAB entry	<ol style="list-style-type: none"> <li>1. Search for a PAB entry.</li> <li>2. Click a name or nickname.</li> <li>3. Edit the entry as needed and click <b>Save</b>.</li> </ol>
Delete a PAB entry	<ol style="list-style-type: none"> <li>1. Search for a PAB entry.</li> <li>2. Select one or more entries.</li> <li>3. Click <b>Delete Selected</b>.</li> </ol>

## Configuring Fast Dials on the Web

This section describes how to assign Fast Dials from your User Options web pages.

If you want to...	Then do this after you log in...
Assign a Fast Dial code to a PAB entry	<ol style="list-style-type: none"><li>1. Create a PAB entry. See the “Using Your Personal Address Book on the Web” section on page 49.</li><li>2. Choose <b>User Options &gt; Fast Dials</b>.</li><li>3. Click <b>Add New</b>.</li><li>4. Change the Fast Dial code, if desired.</li><li>5. Use the Search Options area to find the appropriate PAB entry.</li><li>6. Click a phone number in the Search Results area.</li><li>7. Click <b>Save</b>.</li></ol>
Assign a Fast Dial code to a phone number (without using a PAB entry)	<ol style="list-style-type: none"><li>1. Choose <b>User Options &gt; Fast Dials</b>.</li><li>2. Click <b>Add New</b>.</li><li>3. Change the Fast Dial code, if desired.</li><li>4. Enter a phone number.</li><li>5. Click <b>Save</b>.</li></ol>
Search for a Fast Dial entry	<ol style="list-style-type: none"><li>1. Choose <b>User Options &gt; Fast Dials</b>.</li><li>2. Specify search information and click <b>Find</b>.</li></ol>
Edit a Fast Dial phone number	<ol style="list-style-type: none"><li>1. Choose <b>User Options &gt; Fast Dials</b>.</li><li>2. Search for the Fast Dial entry that you want to edit.</li><li>3. Click on a component of the entry.</li><li>4. Change the phone number.</li><li>5. Click <b>Save</b>.</li></ol>
Delete a Fast Dial entry	<ol style="list-style-type: none"><li>1. Search for a Fast Dial.</li><li>2. Select one or more entries.</li><li>3. Click <b>Delete Selected</b>.</li></ol>

### Tips

- You can create up to 500 Fast Dial and PAB entries.
- You can create a new Fast Dial entry without using a PAB entry. Such Fast Dial entries are labeled “raw” in the User Options pages and do not display a configurable text label.

## Using the Address Book Synchronization Tool

You can use the Cisco Unified CallManager Address Book Synchronizer to synchronize your existing Microsoft Windows Address Book (if applicable) with your PAB. Entries from your Microsoft Windows Address Book will then be accessible on your Cisco Unified IP Phone and User Options web pages. Your system administrator can give you access to Cisco Unified CallManager Address Book Synchronizer and provide detailed instructions.

## Setting Up Speed Dials on the Web

Depending on configuration, your phone can support several speed-dial features:

- Speed-dial numbers
- Abbreviated Dialing
- Fast Dials



**Note** For help using speed dial features, see the “Speed Dialing” section on page 29.

If you want to...	Then do this after you log in...
Set up speed-dial numbers	<ol style="list-style-type: none"> <li>1. Select a device.</li> <li>2. Click <b>Speed Dials</b>.</li> <li>3. Enter a number and label for a speed-dial number on your phone.</li> <li>4. Click <b>Save</b>.</li> </ol> <p><b>Note</b> Your phone uses the ASCII Label field if the phone does not support double-byte character sets.</p>
Set up Abbreviated dialing	<ol style="list-style-type: none"> <li>1. Select a device.</li> <li>2. Click <b>Speed Dials</b>.</li> <li>3. Enter a number and label for an Abbreviated Dialing code.</li> <li>4. Click <b>Save</b>.</li> </ol>
Set up Fast Dials	<p>See the “Configuring Fast Dials on the Web” section on page 50.</p> <p>You can also set up Fast Dials on your phone. See the “Using Personal Directory on Your Phone” section on page 44.</p>

## Setting Up Phone Services on the Web

Phone services can include special phone features, network data, and web-based information (such as stock quotes and movie listings). You must first subscribe to a phone service before accessing it on your phone.

<b>If you want to...</b>	<b>Then do this after you log in and select a device...</b>
Subscribe to a service	<ol style="list-style-type: none"><li>1. Select a device.</li><li>2. Click <b>Phone Services</b>.</li><li>3. Click <b>Add New</b>.</li><li>4. Choose a service from the drop-down list and click <b>Next</b>.</li><li>5. Change the service label and/or enter additional service information, if available (optional).</li><li>6. Click <b>Save</b>.</li></ol>
Search for services	<ol style="list-style-type: none"><li>1. Select a device.</li><li>2. Click <b>Phone Services</b>.</li><li>3. Click <b>Find</b>.</li></ol>
Change or end services	<ol style="list-style-type: none"><li>1. Search for services.</li><li>2. Select one or more entries.</li><li>3. Click <b>Delete Selected</b>.</li></ol>
Change a service name	<ol style="list-style-type: none"><li>1. Search for services.</li><li>2. Click on the service name.</li><li>3. Change the information and click <b>Save</b>.</li></ol>
Access a service on your phone	Press  and choose <b>Services</b> on your phone.

## Controlling User Settings on the Web

User settings include your password, PIN, and language (locale) settings.

If you want to...	Then do this after you log in...
Change your password	<ol style="list-style-type: none"> <li>1. Choose <b>User Options &gt; User Settings</b>.</li> <li>2. In the Browser Password area, enter information.</li> <li>3. Click <b>Save</b>.</li> </ol>
Change your PIN	<ol style="list-style-type: none"> <li>1. Choose <b>User Options &gt; User Settings</b>.</li> <li>2. In the Phone PIN area, enter information.</li> <li>3. Click <b>Save</b>.</li> </ol>
Change the locale (language) for your User Options pages	<ol style="list-style-type: none"> <li>1. Choose <b>User Options &gt; User Settings</b>.</li> <li>2. In the User Locale area of the User Settings page, choose an item from the Locale drop-down list.</li> <li>3. Click <b>Save</b>.</li> </ol>
Change the language (locale) for your phone screen	<ol style="list-style-type: none"> <li>1. Go to the Device Configuration page by choosing <b>User Options &gt; Device</b>.</li> <li>2. Choose an item from the User Locale drop-down list.</li> <li>3. Click <b>Save</b>.</li> </ol>

### Tip

Your PIN and password allow you to access different features and services. For example, use your PIN to log in to Cisco Extension Mobility or Personal Directory on your phone. Use your password to log in to your User Options web pages and Cisco WebDialer on your personal computer. For more information, ask your system administrator.

## Controlling Line Settings on the Web

Line settings affect a specific phone line (directory number). Line settings can include call-forwarding, voice messaging indicators, ring patterns, and line labels.



- Note**
- You can also set up call forwarding directly on your phone. See the “Forwarding All Calls to Another Number” section on page 25.
  - To learn about phone settings that you can access directly on your phone, see the “Using Phone Settings” section on page 39.

If you want to...	Then do this after you log in and select a device...
Set up call forwarding	<ol style="list-style-type: none"><li>1. Select a device.</li><li>2. Click <b>Line Settings</b>.</li><li>3. In the Incoming Call Forwarding area, choose call forwarding settings for various conditions.</li><li>4. Click <b>Save</b>.</li></ol>
Change the message waiting indicator setting	<ol style="list-style-type: none"><li>1. Select a device.</li><li>2. Click <b>Line Settings</b>.</li><li>3. In the Message Waiting Lamp area, choose from various settings.</li></ol> <p><b>Note</b> Typically, the default message waiting setting prompts your phone to display a steady red light from the handset light strip to indicate a new voice message.</p> <ol style="list-style-type: none"><li>4. Click <b>Save</b>.</li></ol>

If you want to...	Then do this after you log in and select a device...
Change the ring pattern	<ol style="list-style-type: none"> <li>1. Select a device.</li> <li>2. Click <b>Line Settings</b>.</li> <li>3. Click <b>Find</b> to search for your phone.</li> <li>4. In the Ring Settings area, choose settings to tell your phone how to indicate an incoming call.</li> <li>5. Click <b>Save</b>.</li> </ol> <p><b>Note</b> The “idle” ring setting pertains if you receive an incoming call when the phone is idle. The “consecutive” ring setting pertains if you receive an incoming call when the phone is active.</p>
Change or create a line text label that appears on your phone screen	<ol style="list-style-type: none"> <li>1. Select a device.</li> <li>2. Click <b>Line Settings</b>.</li> <li>3. In the Line Text Label area, enter a text label.</li> <li>4. Click <b>Save</b>.</li> </ol> <p><b>Note</b> Your phone uses the ASCII Label field if the phone does not support double-byte character sets.</p>

## Using Cisco WebDialer

Cisco WebDialer allows you to make calls on your Cisco Unified IP Phone to directory contacts by clicking on items in a web browser. Your system administrator must configure this feature for you.

If you want to...	Then...
Use WebDialer with your User Options directory	<ol style="list-style-type: none"> <li>1. Log into your User Options web pages. See the “Accessing Your User Options Web Pages” section on page 48.</li> <li>2. Choose <b>User Options &gt; Directory</b> and search for a coworker.</li> <li>3. Click the number that you want to dial.</li> <li>4. If this is your first time using WebDialer, set up preferences and click <b>Submit</b>. (See the last row in this table for details.)</li> <li>5. If the Make Call page appears, click <b>Dial</b>. (See the last row in this table to learn how to suppress this page in the future, if desired.) The call is now placed on your phone.</li> <li>6. To end a call, click <b>Hangup</b> or hang up from your phone.</li> </ol>
Use WebDialer with another online corporate directory (not your User Options directory)	<ol style="list-style-type: none"> <li>1. Log in to a WebDialer-enabled corporate directory and search for coworkers.</li> <li>2. Click the number that you want to dial.</li> <li>3. When prompted, enter your user ID and password.</li> <li>4. If this is your first time using WebDialer, set up preferences and click <b>Submit</b>. (See the last row in this table for details.)</li> <li>5. If the Make Call page appears, click <b>Dial</b>. (See the last row in this table to learn how to suppress this page in the future, if desired.) The call is now placed on your phone.</li> <li>6. To end a call, click <b>Hangup</b> or hang up from your phone.</li> </ol>



If you want to...	Then...
Log out of WebDialer	Click the logout icon in the Make Call or Hang Up page.
Set up, view, or change WebDialer preferences	<p data-bbox="391 232 713 264">Access the Preferences page.</p> <p data-bbox="391 272 1257 337">The Preferences page appears the first time that you use WebDialer (after you click the number that you want to dial.)</p> <p data-bbox="391 345 1224 410">To return to Preferences in the future, click the preferences icon from the Make Call or Hang Up page.</p> <p data-bbox="391 418 991 451">The Preferences page contains the following options:</p> <ul data-bbox="404 459 1257 912" style="list-style-type: none"> <li data-bbox="404 459 1186 524">• Preferred language—Determines the language used for WebDialer settings and prompts.</li> <li data-bbox="404 532 1257 719">• Use permanent device—Identifies the Cisco Unified IP Phone and directory number (line) that you will use to place WebDialer calls. If you have one phone with a single line, the appropriate phone and line are automatically selected. Otherwise, choose a phone and/or line. Phones are specified by host name. (To display the host name on your phone, press  and choose <b>Settings &gt; Network Configuration &gt; Host Name.</b>)</li> <li data-bbox="404 727 1257 816">• Use Extension Mobility—If selected, prompts WebDialer to use the Cisco Unified IP Phone that is associated with your Extension Mobility profile (if available).</li> <li data-bbox="404 824 1257 912">• Do not display call confirmation—If selected, prompts WebDialer to suppress the Make Call page. This page appears by default after you click a phone number in a WebDialer-enabled online directory.</li> </ul>

# Understanding Additional Configuration Options

Your system administrator can configure your phone to use specific button and softkey templates along with special services and features, if appropriate. This table provides an overview of some configuration options that you might want to discuss with your phone system administrator based on your calling needs or work environment.



**Note** You can locate Phone Guides and other documents listed in this table on the web:  
[http://www.cisco.com/univercd/cc/td/doc/product/voice/c\\_ipphon/index.htm](http://www.cisco.com/univercd/cc/td/doc/product/voice/c_ipphon/index.htm)

<b>If you...</b>	<b>Then...</b>	<b>For more information...</b>
Need to handle more calls on your phone line	Ask your system administrator to configure your line to support more calls.	Talk to your system administrator or phone support team.
Work with (or work as) an administrative assistant	Consider using a shared line.	See the “Using a Shared Line” section on page 31.
Want to use one extension for several phones	Request a shared line. This allows you to use one extension for your desk phone and lab phone, for example.	See the “Using a Shared Line” section on page 31.

If you...	Then...	For more information...
Share phones or office space with coworkers	Consider using: <ul style="list-style-type: none"> <li>• Call Park to store and retrieve calls without using the transfer feature.</li> <li>• Call Pickup to answer calls ringing on another phone.</li> <li>• A shared line to view or join co-workers' calls.</li> <li>• Cisco Extension Mobility to apply your phone number and user profile to a shared Cisco Unified IP Phone.</li> </ul>	Ask your system administrator about these features and see the: <ul style="list-style-type: none"> <li>• “Advanced Call Handling” section on page 29.</li> <li>• “Using a Shared Line” section on page 31.</li> <li>• “Using Cisco Extension Mobility” section on page 35.</li> </ul>
Want to temporarily apply your phone number and settings to a shared Cisco Unified IP Phone	Ask your system administrator about the Cisco Extension Mobility service.	See the “Using Cisco Extension Mobility” section on page 35.

# Troubleshooting Your Phone

---

This section provides troubleshooting information for your Cisco Unified Unified IP Phone.



## General Troubleshooting

This section provides information to help you troubleshoot general problems with your phone. For more information, see your system administrator.

Symptom	Explanation
You cannot hear a dial tone or complete a call	One or more of the following factors might apply: <ul style="list-style-type: none"><li>• You must log into the Extension Mobility service.</li><li>• You must enter a client matter code (CMC) or forced authorization code (FAC) after dialing a number.</li><li>• Your phone has time-of-day restrictions that prevent you from using some features during certain hours of the day.</li></ul>
The softkey that you want to use does not appear	One or more of the following factors might apply: <ul style="list-style-type: none"><li>• You must press <b>more</b> to reveal additional softkeys.</li><li>• You must change the line state (for example, go off-hook or have a connected call).</li><li>• Your phone is not configured to support the feature associated with that softkey.</li></ul>
<b>Barge</b> fails and results in a fast busy tone	You cannot barge an encrypted call if the phone you are using is not configured for encryption. When your barge attempt fails for this reason, your phone plays a fast busy tone.
You are disconnected from a call that you joined using <b>Barge</b>	You will be disconnected from a call that you have joined using <b>Barge</b> if the call is put on hold, transferred, or turned into a conference call.
Cisco <b>CallBack</b> fails	The other party might have call forwarding enabled.

## Viewing Phone Administration Data

Your system administrator might ask you to access administration data on your phone for troubleshooting purposes.

If you are asked to...	Then...
Access network configuration data	Press  and choose <b>Settings &gt; Network Configuration</b> and select the network configuration item that you want to view.
Access status data	Press  and choose <b>Settings &gt; Status</b> and select the status item that you want to view.
Access phone model information	Press  and choose <b>Settings &gt; Model Information</b> .

## Using the Quality Reporting Tool

Your system administrator may temporarily configure your phone with the Quality Reporting Tool (QRT) to troubleshoot performance problems. You can press **QRT** to submit information to your system administrator. Depending on configuration, use the QRT to:

- Immediately report an audio problem on a current call
- Select a general problem from a list of categories and choose reason codes

# Cisco One-Year Limited Hardware Warranty Terms

---

There are special terms applicable to your hardware warranty and various services that you can use during the warranty period. Your formal Warranty Statement, including the warranties and license agreements applicable to Cisco software, is available on Cisco.com. Follow these steps to access and download the *Cisco Information Packet* and your warranty and license agreements from Cisco.com.

1. Launch your browser, and go to this URL:  
[http://www.cisco.com/univercd/cc/td/doc/es\\_inpk/cetrans.htm](http://www.cisco.com/univercd/cc/td/doc/es_inpk/cetrans.htm)  
The Warranties and License Agreements page appears.
2. To read the *Cisco Information Packet*, follow these steps:
  - a. Click the **Information Packet Number** field, and make sure that the part number 78-5235-03A0 is highlighted.
  - b. Select the language in which you would like to read the document.
  - c. Click **Go**.
  - d. The Cisco Limited Warranty and Software License page from the Information Packet appears.
  - e. Read the document online, or click the **PDF** icon to download and print the document in Adobe Portable Document Format (PDF).



---

**Note**

You must have Adobe Acrobat Reader to view and print PDF files. You can download the reader from Adobe's website: <http://www.adobe.com>

---

3. To read translated and localized warranty information about your product, follow these steps:
  - a. Enter this part number in the Warranty Document Number field:  
78-10747-01C0
  - b. Select the language in which you would like to view the document.
  - c. Click **Go**.  
The Cisco warranty page appears.
  - d. Read the document online, or click the **PDF** icon to download and print the document in Adobe Portable Document Format (PDF).

You can also contact the Cisco service and support website for assistance:

[http://www.cisco.com/public/Support\\_root.shtml](http://www.cisco.com/public/Support_root.shtml).

## Duration of Hardware Warranty

One (1) Year

**Replacement, Repair, or Refund Policy for Hardware**

Cisco or its service center will use commercially reasonable efforts to ship a replacement part within ten (10) working days after receipt of a Return Materials Authorization (RMA) request. Actual delivery times can vary, depending on the customer location.

Cisco reserves the right to refund the purchase price as its exclusive warranty remedy.

**To Receive a Return Materials Authorization (RMA) Number**

Contact the company from whom you purchased the product. If you purchased the product directly from Cisco, contact your Cisco Sales and Service Representative.

Complete the information below, and keep it for reference.

Company product purchased from	
Company telephone number	
Product model number	
Product serial number	
Maintenance contract number	







## Index

---

### A

- Abbreviated Dialing 21, 29
- answering calls 22
- Applications Menu button 17
- Applications menus, using 18
- ASCII label field support 52, 56
- authenticated calls 34
- Auto Dial 20
- AutoAnswer 22

### B

- background image, customizing 41
- barge
  - and privacy 33
  - and shared lines 31
  - using 32
- buttons, identifying 16

### C

- call forwarding 25
  - configuring from web page 55
  - configuring on phone 25

- call logs
  - dialing from 20
  - erasing 42
  - viewing and dialing from 42
- call park 22, 34
- call pickup 22, 30
- call waiting 22
- CallBack 21
- caller ID 17
- call-handling
  - advanced 29
  - basic 20
- calls
  - answering 22
  - blocking 26
  - compared to lines 18
  - conference features for 26
  - ending 23
  - forwarding 25
  - handling multiple 22
  - holding and resuming 23
  - icons for 19
  - maximum per line 18
  - monitoring 37
  - multiple parties on 26
  - multiple, switching between 23
  - parking 34

- placing 20, 21
- prevent barging of 33
- redirecting while ringing 30
- reporting problems with 62
- secure 34
- storing and retrieving 34
- transferring 24
- using DND 26
- viewing 17, 24

cBarge

- See also barge
- using 32

Cisco Extension Mobility feature, using 22

Cisco Unified CallManager Address Book Synchronizer 52

Cisco Unified IP Phone

- connecting 12
- documentation for 2
- feature configuration for 19
- illustration 16
- registering 14
- securing handset rest 14
- troubleshooting 61
- web-based services for 53

Cisco WebDialer 56

Client Matter Code, see CMC

CMC 61

conference calls

- Meet-Me 27, 28
- standard 27

corporate directory

- dialing from 21
- dialing from web page 21
- using on phone 44

## D

Device Configuration page 49

dialing options

- additional 21
- basic 20

dialing, options for 20, 21

directory

- corporate 44
- personal 45
- using from web page 56
- using on phone 42

directory, dialing from 21

DND 26

Do Not Disturb 26

documentation, accessing 2

## E

encrypted calls 34

ending a call, options 23

Extension Mobility

- EM 35

external devices, using 11

## F

FAC 61

Fast Dials

- configuring from web page 46
- using on phone 45

features, availability of 19

Forced Authorization Code, see FAC

forwarding calls, options for 25

## **G**

group call pickup 30

Group Listen 37

## **H**

handset

- light strip 17

- securing in cradle 14

- using 37, 38

hands-free listening 37

hanging up, options for 23

headset

- connecting 14

- performance 15

help, using 18

hold

- and switching calls 23

- and transferring 24

- using 23

hold button illustration 17

## **I**

icons, for call states 19

iDivert

- description of 48

- transferring calls with 24

installing, Cisco Unified IP Phone 12

## **K**

keypad description 17

## **L**

language (locale) settings 54

lines

- compared to calls 18

- description 18

- description of 18

- number of calls supported on 18, 59

- ring patterns for 56

- shared 31

- text label for 56

- voice message indicator setting for 55

## **M**

Meet-Me conferences 27, 28

menus, using 18

messages

- indicator for 40

- listening to 48

missed calls, records of 42

monitoring a call 37

multiple calls, handling 22, 24

## **N**

navigation button illustration 17

## **O**

off-hook dialing 20

on-hook dialing 20

## **P**

### **PAB**

- using from web page 50
- using on phone 45

parking a call 22

password, changing 54

Personal Address Book, dialing from 21

Personal Address Book, see PAB

### **Personal Directory**

- using from web page 50
- using on phone 45

phone lines, description of 18

phone services

- configuring, see also User Options web pages

### **PIN**

- changing 54

placed calls, records of 42

placing a call 20

placing calls, options for 20, 21

pre-dial 20

privacy

- and shared lines 31
- using 33

## **Q**

QRT 62

Quality Reporting Tool 62

## **R**

received calls, records of 42

redial 20

remote-in-use icon for shared lines 31

resuming held calls 23

ring patterns, changing 56

ring tones, changing 40

ringer

- customizing 40
- indicator for 17
- volume for 40

## **S**

safety warnings 2

secure calls 34

security, for calls 34

services

- subscribing to 53

settings, customizing 40

shared lines

- and remote-in-use icon 31
- description of 31
- with barge 32
- with privacy 33

softkey buttons, description of 17

sound quality 15

speaker

- answering calls with 22
- using 23

speaker, using 37

speed dial

- configuring 29
- description of 29

- labels 52
  - using 21
- subscriptions, for phone services 53
- switching calls 23

## **T**

- TAPS 14
- Tool for Auto-Registered Phones Support 14
- transferring, options for 24
- troubleshooting
  - general 61
  - QRT 62

## **U**

- URL dialing, from call log 43
- User Options web pages
  - accessing 49
  - configuring features and services with
  - subscribing to phone services with 53
- using a headset 14

## **V**

- voice message indicator
  - changing setting for 55
  - description of 48
- voice messages, accessing 48
- volume
  - for handset, headset, or speaker 37, 38
  - for phone ringer 40
- volume button illustration 17

## **W**

- warnings, safety 2
- web-based services
  - configuring
  - see also User Options web pages
- WebDialer 56







**Corporate Headquarters**  
Cisco Systems, Inc.  
170 West Tasman Drive  
San Jose, CA 95134-1706  
USA  
www.cisco.com  
Tel: 408 526-4000  
800 553-NETS (6387)  
Fax: 408 526-4100

**European Headquarters**  
Cisco Systems International BV  
Haarlerbergpark  
Haarlerbergweg 13-19  
1101 CH Amsterdam  
The Netherlands  
www-europe.cisco.com  
Tel: 31 0 20 357 1000  
Fax: 31 0 20 357 1100

**Americas Headquarters**  
Cisco Systems, Inc.  
170 West Tasman Drive  
San Jose, CA 95134-1706  
USA  
www.cisco.com  
Tel: 408 526-7660  
Fax: 408 527-0883

**Asia Pacific Headquarters**  
Cisco Systems, Inc.  
168 Robinson Road  
#28-01 Capital Tower  
Singapore 068912  
www.cisco.com  
Tel: +65 6317 7777  
Fax: +65 6317 7799

**Cisco Systems has more than 200 offices in the following countries. Addresses, phone numbers, and fax numbers are listed on the Cisco Website at [www.cisco.com/go/offices](http://www.cisco.com/go/offices)**

Argentina • Australia • Austria • Belgium • Brazil • Bulgaria • Canada • Chile • China PRC • Colombia • Costa Rica • Croatia • Cyprus • Czech Republic • Denmark • Dubai, UAE  
Finland • France • Germany • Greece • Hong Kong SAR • Hungary • India • Indonesia • Ireland • Israel • Italy • Japan • Korea • Luxembourg • Malaysia • Mexico  
The Netherlands • New Zealand • Norway • Peru • Philippines • Poland • Portugal • Puerto Rico • Romania • Russia • Saudi Arabia • Scotland • Singapore  
Slovakia • Slovenia • South Africa • Spain • Sweden • Switzerland • Taiwan • Thailand • Turkey • Ukraine • United Kingdom • United States • Venezuela • Vietnam • Zimbabwe

CCSP, CCVP, the Cisco Square Bridge logo, Follow Me Browsing, and StackWise are trademarks of Cisco Systems, Inc.; Changing the Way We Work, Live, Play, and Learn, and iQuick Study are service marks of Cisco Systems, Inc.; and Access Registrar, Aironet, BPX, Catalyst, CCDA, CCDP, CCIE, CCIIP, CCNA, CCNP, Cisco, the Cisco Certified Internetwork Expert logo, Cisco IOS, Cisco Press, Cisco Systems, Cisco Systems Capital, the Cisco Systems logo, Cisco Unity, Enterprise/Solver, EtherChannel, EtherFast, EtherSwitch, Fast Step, FormShare, GigaDrive, GigaStack, HomeLink, Internet Quotient, IOS, IPTV, iQ Expertise, the iQ logo, iQ Net Readiness Scorecard, LightStream, Linksys, MeetingPlace, MGX, the Networkers logo, Networking Academy, Network Registrar, Packet, PIX, Post-Routing, Pre-Routing, ProConnect, RateMUX, ScriptShare, SlideCast, SMARTnet, The Fastest Way to Increase Your Internet Quotient, and TransPath are registered trademarks of Cisco Systems, Inc. and/or its affiliates in the United States and certain other countries.

All other trademarks mentioned in this document or Website are the property of their respective owners. The use of the word partner does not imply a partnership relationship between Cisco and any other company. (0601R)

© 2006 Cisco Systems, Inc. All rights reserved.



The Java logo is a trademark or registered trademark of Sun Microsystems, Inc. in the U.S. or other countries.