





Cisco Unified IP Phone 7906G and 7911G Phone Guide for Cisco Unified Communications Manager 6.1(3) (SCCP and SIP)

Americas Headquarters

Cisco Systems, Inc.
170 West Tasman Drive
San Jose, CA 95134-1706
USA
<http://www.cisco.com>
Tel: 408 526-4000
800 553-NETS (6387)
Fax: 408 527-0883

Common Phone Tasks

View online help on the phone	Press  and choose Help .
Place a call	Go off-hook before or after dialing a number.
Redial a number	Press Redial .
Talk using the handset and listen on the speaker	(Group Listen mode only.) Press GListen .
Listen on the speaker only	(Monitor mode only.) Press Monitor .
Use your call logs	Press  and select Directories > Missed Calls, Placed Calls, or Received Calls . Select a number and press Dial .
Edit a number	Press EditDial , << or >>.
Hold/resume a call	Highlight a call to put on hold or resume from hold, and press  .
Transfer a call to a new number	Press Transfer , enter the number, then press Transfer again.
Start a standard (ad hoc) conference call	Press more > Confrn and dial the participant, then press Confrn again.



Cisco, Cisco Systems, the Cisco logo, and the Cisco Systems logo are registered trademarks or trademarks of Cisco Systems, Inc. and/or its affiliates in the United States and certain other countries. All other trademarks mentioned in this document or Website are the property of their respective owners. The use of the word partner does not imply a partnership relationship between Cisco and any other company. (0705R)

© 2008 Cisco Systems, Inc. All rights reserved.

OL-17707-01



QUICK REFERENCE



Cisco Unified IP Phone 7906G and 7911G for Cisco Unified Communications Manager 6.1(3) (SCCP and SIP)



















Softkey Definitions
 Phone Screen Icons
 Button Icons
 Speed Dialing
 Common Phone Tasks



Softkey Definitions

AbbrDial	Dial using a speed-dial index number
Answer	Answer a call
Barge	Add yourself to a call on a shared line
CallBack	Receive notification when a busy extension becomes available
Cancel	Cancel an action or exit a screen without applying changes
cBarge	Add yourself to a call on a shared line and establish a conference
CFwdALL	Setup/cancel call forwarding
Clear	Delete records or settings
Close	Close the current window
ConfList	View conference participants
Confrn	Create a conference call
Delete	Remove characters to the right of the cursor when using EditDial
Details (SCCP only)	Opens the Details call record for a multiparty call in the Missed Calls and Received Calls logs
Dial	Dial a phone number
DirTrfr (SCCP only)	Transfer two calls to each other
DND	Turn on/off Do Not Disturb (DND)
EditDial	Edit a number in a call log
EndCall	Disconnect the current call
Erase	Reset settings to their defaults
Exit	Return to the previous screen
GListen	Talk using the handset and listen on the speaker (Group Listen)





GLOff	Disable Group Listen
GPickUp	Answer a call ringing in another group
iDivert	Send or redirect a call to a voice message system
Join (SCCP only)	Join several calls on a single line to create a conference
MeetMe	Host a Meet-Me conference call
Monitor	Listen to a call on the speaker
MonOff	Disable the Monitor function
more	Display additional softkeys
Msgs	Access voice mail system
New Call	Make a new call
OPickUp	Answer a call ringing in an associated group
Park	Store a call using Call Park
PickUp	Answer a call in your group
QRT	Submit call problems to the system administrator
Redial	Redial the most recently dialed number
Remove	Remove a conference participant
RMLstC	Drop the last party added to a conference call
Search	Search for a directory listing
Transfer	Transfer a call
Update	Refresh content
VidMode (SCCP only)	Choose a video display mode
<<	Delete entered characters
>>	Move through entered characters

Phone Screen Icons



Line and Call Status	
	Call Forwarding enabled
	Call on hold; remote call on hold
	Connected call
	Off-hook
	On-hook
	Incoming call
	Shared line in use
	Authenticated call
	Encrypted call
	Priority call
	Medium priority call
	High priority call
	Highest priority call
Other Features	
	Speed Dial configured
	Message waiting
	Option selected
	Feature enabled
	URL entry in call log is ready to edit (SIP only)

Audio or Video Mode	
	Handset in use
	Speaker in use (Monitor on)
	Video enabled (Cisco Unified IP Phone 7911G only with SCCP)

Button Icons

	Volume
	Navigation
	Hold
	Applications Menu

Speed Dialing

If you want to...	Then...
Speed dial a number	<ul style="list-style-type: none"> Press  and select a number to dial. Press  and choose Directories > Speed Dials. Select a number to dial. Enter a speed-dial number while on-hook and press AbbrDial.

Contents

Getting Started 1

- Using this Guide 1
- Finding Additional Information 1
- Safety and Performance Information 2
- Cisco Product Security Overview 3
- Accessibility Features 3

Connecting Your Phone 5

An Overview of Your Phone 9

- Understanding Buttons and Hardware 9
- Understanding Lines vs. Calls 11
 - Understanding Line and Call Icons 11
- Accessing Applications Menus 12
- Accessing the Help System on Your Phone 12
- Understanding Feature Availability 12
- Understanding SIP vs. SCCP 13

Basic Call Handling 14

- Placing a Call—Basic Options 14
- Placing a Call—Additional Options 15
- Answering a Call 17
- Ending a Call 18
- Using Hold and Resume 18
- Switching Between Multiple Calls 19
- Switching an In-Progress Call to Another Phone 19
- Viewing Multiple Calls 19
- Transferring Calls 20
- Sending a Call to a Voice Message System 21
- Forwarding Calls to Another Number 21

Using Do Not Disturb	22
Making Conference Calls	23
Using Conference Features	23
Using Conference	24
Using Join	24
Using cBarge	25
Using Meet-Me	25
Viewing or Removing Conference Participants	26

Advanced Call Handling 27

Speed Dialing	27
Picking Up a Redirected Call on Your Phone	28
Storing and Retrieving Parked Calls	29
Logging Out of Hunt Groups	29
Using a Shared Line	30
Understanding Shared Lines	30
Using Barge to Add Yourself to a Shared-Line Call	31
Understanding Barge Features	31
Using Barge Features	31
Preventing Others from Viewing or Barging a Shared-Line Call	32
Making and Receiving Secure Calls	32
Tracing Suspicious Calls	33
Prioritizing Critical Calls	33
Using Cisco Extension Mobility	35
Managing Business Calls Using a Single Phone Number	35

Using a Handset, Headset, and Speaker 38

Using the Group Listen Feature	38
Using the Monitor Feature	38
Using and Obtaining a Headset	39
Using AutoAnswer	40

Changing Phone Settings 41

Customizing Rings and Message Indicators	41
--	----

Customizing the Phone Screen 42

Using Call Logs and Directories 43

Using Call Logs 43

Directory Dialing 45

 Using Corporate Directory on Your Phone 45

 Using Personal Directory on Your Phone 46

Accessing Voice Messages 49

Using the User Options Web Pages 50

Accessing Your User Options Web Pages 50

Configuring Features and Services on the Web 51

 Using Personal Directory on the Web 51

 Using Your Personal Address Book on the Web 51

 Configuring Fast Dials on the Web 52

 Using the Address Book Synchronization Tool 53

 Setting Up Speed Dials on the Web 53

 Setting Up Phone Services on the Web 55

 Controlling User Settings on the Web 56

 Controlling Line Settings on the Web 56

 Setting Up Phones and Access Lists for Mobile Connect 58

 Using Cisco WebDialer 59

Understanding Additional Configuration Options 62

Troubleshooting Your Phone 63

General Troubleshooting 63

Viewing Phone Administration Data 64

Using the Quality Reporting Tool 64

Cisco One-Year Limited Hardware Warranty Terms 65

Index 67

Getting Started

Using this Guide

This guide provides you with an overview of the features available on your phone. You can read it completely for a solid understanding of your phone's capabilities, or refer to the table below for pointers to commonly-used sections.

If you want to...	Then...
Explore your phone on your own	Press  and choose Help .
Review safety information	See Safety and Performance Information , page 2.
Connect your phone	See Connecting Your Phone , page 5.
Use your phone after it is installed	Start with An Overview of Your Phone , page 9.
Learn about the phone buttons	See Understanding Buttons and Hardware , page 9.
Make calls	See Placing a Call—Basic Options , page 14.
Put calls on hold	See Using Hold and Resume , page 18.
Transfer calls	See Transferring Calls , page 20.
Make conference calls	See Making Conference Calls , page 23.
Set up speed dialing	See Speed Dialing , page 27.
Share a phone number	See Using a Shared Line , page 30.
Use the speaker on the phone	See Using a Handset, Headset, and Speaker , page 38.
Change the ring volume or tone	See Changing Phone Settings , page 41.
View your missed calls	See Using Call Logs and Directories , page 43.
Listen to your voice messages	See Accessing Voice Messages , page 49.
See softkey and icon definitions	Refer to the Quick Reference Card in the front of this guide.

Finding Additional Information

You can access the most current Cisco documentation on the World Wide Web at this URL:

http://www.cisco.com/en/US/products/hw/phones/ps379/tsd_products_support_series_home.html

You can access the Cisco website at this URL:

<http://www.cisco.com/>

International Cisco websites can be accessed from this URL:

http://www.cisco.com/public/countries_languages.shtml

You can access the most current Licensing Information at this URL:

http://www.cisco.com/en/US/docs/voice_ip_comm/cuipph/all_models/openssl_license/7900_ssllic.htm

Safety and Performance Information

Refer to these sections for information about the impact of power outages and other devices on your Cisco Unified IP Phone.

Power Outage

Your accessibility to emergency service through the phone is dependent on the phone being powered. If there is an interruption in the power supply, Service and Emergency Calling Service dialing will not function until power is restored. In the case of a power failure or disruption, you may need to reset or reconfigure equipment before using the Service or Emergency Calling Service dialing.

Using External Devices

The following information applies when you use external devices with the Cisco Unified IP Phone:

Cisco recommends the use of good quality external devices (headsets) that are shielded against unwanted radio frequency (RF) and audio frequency (AF) signals.

Depending on the quality of these devices and their proximity to other devices such as mobile phones or two-way radios, some audio noise may still occur. In these cases, Cisco recommends that you take one or more of the following actions:

- Move the external device away from the source of the RF or AF signals.
- Route the external device cables away from the source of the RF or AF signals.
- Use shielded cables for the external device, or use cables with a better shield and connector.
- Shorten the length of the external device cable.
- Apply ferrites or other such devices on the cables for the external device.

Cisco cannot guarantee the performance of the system because Cisco has no control over the quality of external devices, cables, and connectors. The system will perform adequately when suitable devices are attached using good quality cables and connectors.



Caution

In European Union countries, use only headsets that are fully compliant with the EMC Directive [89/336/EC].

Cisco Product Security Overview

This product contains cryptographic features and is subject to United States and local country laws governing import, export, transfer and use. Delivery of Cisco cryptographic products does not imply third-party authority to import, export, distribute or use encryption. Importers, exporters, distributors and users are responsible for compliance with U.S. and local country laws. By using this product you agree to comply with applicable laws and regulations. If you are unable to comply with U.S. and local laws, return this product immediately.

Further information regarding U.S. export regulations may be found at http://www.access.gpo.gov/bis/ear/ear_data.html.

Accessibility Features

A list of accessibility features is available upon request. You can find more information about Cisco accessibility features at this URL:

www.cisco.com/go/accessibility

Connecting Your Phone

Your system administrator will likely connect your new Cisco Unified IP Phone to the corporate IP telephony network. If that is not the case, refer to the graphics below to connect your phone.

The following graphic and table show how to connect the Cisco Unified IP Phone 7906G:

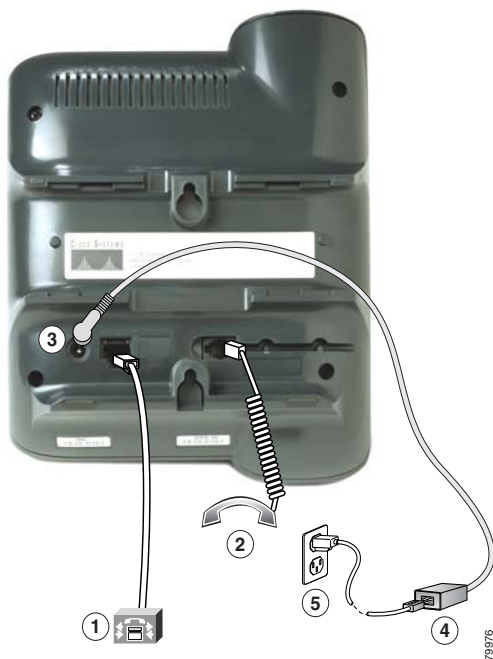

1	Network port (10/100 SW)	4	AC-to-DC power supply
2	Handset port	5	AC power cord
3	DC adapter port (DC48V)		

The following graphic and table show how to connect the Cisco Unified IP Phone 7911G:

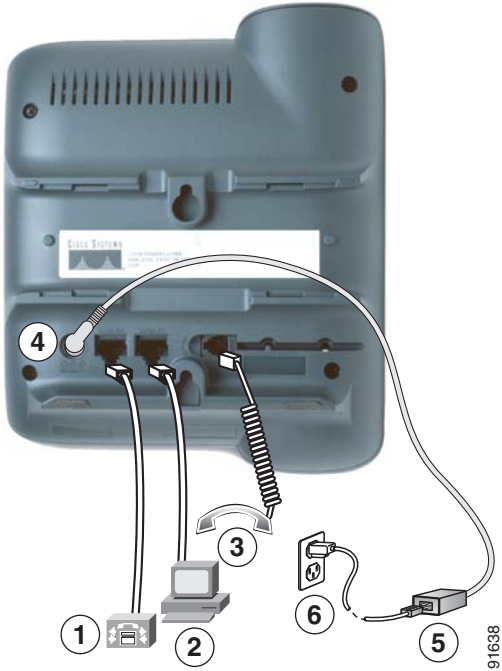

1	Network port (10/100 SW)	4	DC adapter port (DC48V)
2	Access port (10/100 PC)	5	AC-to-DC power supply
3	Handset port	6	AC power cord

Adjusting the Handset Rest

When you connect your phone, you might want to adjust the handset rest to ensure that the receiver will not slip out of the cradle. See the table below for instructions.

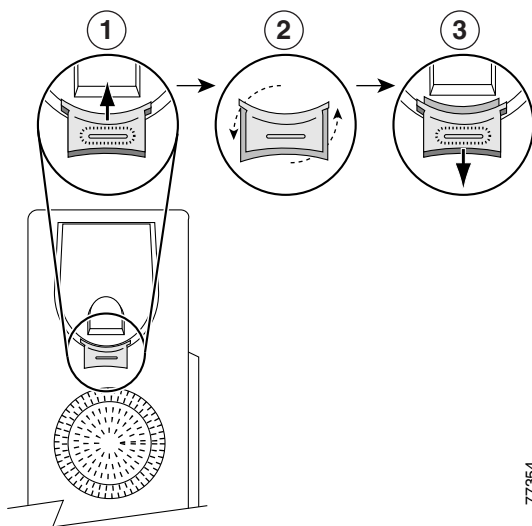

77354

1	Set the handset aside and pull the square plastic tab from the handset rest.
2	Rotate the tab 180 degrees.
3	Slide the tab back into the handset rest. An extension protrudes from the top of the rotated tab. Return the handset to the handset rest.

Registering with TAPS

After your phone is connected to the network, your system administrator might ask you to auto-register your phone using the Tool for Auto-Registered Phones Support (TAPS). TAPS might be used either for a new phone or to replace an existing phone.

To register with TAPS, pick up the handset, enter the TAPS extension provided by your system administrator, and follow the voice prompts. You might need to enter your entire extension, including the area code. After your phone displays a confirmation message, hang up. The phone will restart.

Headset Information

To use a headset, make sure the handset is disconnected, then connect the headset to the Handset port on the back of your phone.

Depending on headset manufacturer's recommendations, an external amplifier may be required. Refer to headset manufacturer's product documentation for more information.

Although Cisco Systems performs some internal testing of third-party headsets for use with the Cisco Unified IP Phones, Cisco does not certify or support products from headset or handset vendors. Because of the inherent environmental and hardware inconsistencies in the locations where Cisco Unified IP Phones are deployed, there is not a single "best" solution that is optimal for all environments. Cisco recommends that customers test the headsets that work best in their environment before deploying a large number of units in their network.

In some instances, the mechanics or electronics of various headsets can cause remote parties to hear an echo of their own voice when they speak to Cisco Unified IP Phone users.

Cisco Systems recommends the use of good quality external devices (headsets) that are screened against unwanted radio frequency (RF) and audio frequency (AF) signals. Depending on the quality of these devices and their proximity to other devices such as cell phones and two-way radios, some audio noise may still occur.

The primary reason that support of a headset would be inappropriate for the Cisco Unified IP Phone is the potential for an audible hum. This hum can either be heard by the remote party or by both the remote party and you, the Cisco Unified IP Phone user. Some potential humming or buzzing sounds can be caused by a range of outside sources, for example, electric lights, being near electric motors, large PC monitors. In some cases, a hum experienced by a user may be reduced or eliminated by using a local power cube or power injector.

Audio Quality Subjective to the User

Beyond the physical, mechanical and technical performance, the audio portion of a headset must sound good to you (the user) and to the party on the far end. Sound is subjective and Cisco cannot guarantee the performance of any headsets or handsets, but some of the headsets and handsets on the sites listed below have been reported to perform well with Cisco Unified IP Phones.

Nevertheless, it is ultimately still the customer's responsibility to test this equipment in their own environment to determine suitable performance.

For information about headsets, see:

<http://www.vxicorp.com/cisco>

<http://www.plantronics.com>

<http://www.jabra.com>

An Overview of Your Phone

Cisco Unified IP Phone 7906G and 7911G are full-feature telephones that provide voice communication over the same data network that your computer uses, allowing you to place and receive calls, put calls on hold, transfer calls, make conference calls, and so on.





In addition to basic call-handling features, your Cisco Unified IP Phone 7906G and 7911G can provide specialized or advanced telephony features that extend your call-handling capabilities. Depending on configuration, your phone supports:

- Access to network data, XML applications, and web-based services.
- Online customizing of phone features and services from your User Options web pages.

Understanding Buttons and Hardware

You can use this graphic below to identify the buttons and hardware on your phone.



	Item	Description	For more information, see...
1	Phone screen	Displays phone menus and call activity including caller ID, call duration, and call state.	Accessing Applications Menus, page 12 and Understanding Feature Availability, page 12.
2	Cisco Unified IP Phone series	Indicates your Cisco Unified IP Phone model series.	—
3	Softkey buttons	Each activates a softkey option displayed on your phone screen.	Softkey Definitions, page 3.
4	Navigation button 	Allows you to scroll through menu items and highlight items. When the phone is on-hook, displays your Speed Dials.	Accessing Applications Menus, page 12 and Speed Dialing, page 27.
5	Applications Menu button 	Displays the Applications menu that provides access to a voice message system, phone logs and directories, settings, services, and help.	Accessing Applications Menus, page 12.
6	Hold button 	Places the active call on hold, resumes a call on hold, and switches between an active call and a call on hold.	Using Hold and Resume, page 18.
7	Keypad	Allows you to dial phone numbers, enter letters, and choose menu items.	Basic Call Handling, page 14.
8	Volume button 	Controls the handset, headset, speaker, and ringer volume.	Using a Handset, Headset, and Speaker, page 38.
9	Handset with light strip	The light strip on the handset indicates an incoming call or new voice message.	Accessing Voice Messages, page 49.
10	Footstand	Allows the phone to stand at a convenient angle on a desk or table.	—











Understanding Lines vs. Calls

To avoid confusion about lines and calls, refer to these descriptions:

- Lines—Each line corresponds to a phone number (or extension) that others can use to call you. Your phone can support one line.
- Calls—Each line can support multiple calls. By default, your phone supports up to six connected calls, but your system administrator can adjust this number according to your needs. Only one call can be active at any time; other calls are automatically placed on hold.





Understanding Line and Call Icons

Your phone displays icons to help you determine the call and line state (on-hook, on hold, ringing, connected, and so on).

Icon	Call or line state	Description
	On-hook line	No call activity on this line.
	Off-hook line	You are dialing a number or an outgoing call is ringing.
	Connected call	You are connected to the other party.
	Ringing call	A call is ringing on your line.
	Call on hold	You have put this call on hold. See Using Hold and Resume, page 18 .
	Remote call on hold	Another phone that shares your line has put a call on hold. See Using Hold and Resume, page 18 .
	Remote-in-use	Another phone that shares your line has a connected call. See Understanding Shared Lines, page 30 .
	Reverting call	A holding call is reverting to your phone. See Using Hold and Resume, page 18 .
	Authenticated call	See Making and Receiving Secure Calls, page 32 .
	Encrypted call	See Making and Receiving Secure Calls, page 32 .





Accessing Applications Menus

Use the Applications menus to access phone features.

If you want to...	Then...
Access the Applications menus	Press  to display a list of Applications: Messages, Directory, Settings, Services, and Help.
Scroll through a list or menu	Press  .
Select a menu item	Press  to highlight a menu item, then press Select . You can also press the number on the keypad that corresponds to the number for the menu item.
Go back one level in a menu	Press Exit . (Note that if you press Exit from the top-level of a menu, the menu will close.)
Close a menu (and return to the Applications menu)	Press Exit one or more times until the menu closes, or press  .
Exit the Applications menu	Press  or Exit .



Tip

After you press , the LED turns green and stays lit while you are using the Applications menus. If you depart from an application without pressing  or **Exit** (for example, to answer a new call), the phone screen display may change but the  button stays green. If you press  again, the application that you were using resumes at the point when it was interrupted.

Accessing the Help System on Your Phone

The Cisco Unified IP Phone 7906G and 7911G provide a comprehensive online help system. To view the phone help, press  and choose **Help**.

Understanding Feature Availability

Depending on your phone system configuration, features included in this Phone Guide might not be available to you or might work differently on your phone. Contact your support desk or system administrator for information about feature operation or availability.

Understanding SIP vs. SCCP

Your phone can be configured to work with one of two signaling protocols: SIP (Session Initiation Protocol) or SCCP (Skinny Call Control Protocol). Your system administrator determines this configuration.

Phone features can vary depending on the protocol. This Phone Guide indicates which features are protocol-specific. To learn which protocol your phone is using, you can ask your system administrator or you can choose  > **Model Information** > **Call Control Protocol** on your phone.

Basic Call Handling

You can perform basic call-handling tasks using a range of features and services. Feature availability can vary; see your system administrator for more information.

Placing a Call—Basic Options

Here are some easy ways to place a call on your Cisco Unified IP Phone.





If you want to...	Then...	For more information, see...
Place a call	Pick up the handset and dial the number.	An Overview of Your Phone, page 9.
Dial on-hook (with dial tone)	Press New Call and dial the number.	—
Redial a number	Press Redial .	—
Place a call when another call is active	<ol style="list-style-type: none">1. Press ⊙.2. Press New Call.3. Enter a number.	Using Hold and Resume, page 18.
Dial from a call log	<ol style="list-style-type: none">1. Press 📞 and select Directories > Missed Calls, Received Calls, or Placed Calls.2. Scroll to the number and press Dial.	Using Call Logs, page 43.

Tips

- You can dial on-hook without a dial tone (pre-dial). To pre-dial, enter a number, then go off-hook by lifting the handset and press **Dial**.
- When you pre-dial, your phone tries to anticipate the number you are dialing by displaying matching numbers (if available) from your Placed Calls log. This is called Auto Dial. To call a number displayed with Auto Dial, scroll to it, press **Dial**, and go off-hook.
- If you make a mistake while dialing, press **<<** to erase digits.
- If parties on a call hear a beep tone, the call might be monitored or recorded. Ask your system administrator for more information.

Placing a Call—Additional Options

You can place calls using special features and services that might be available on your phone. See your system administrator for more information about these additional options.

If you want to...	Then...	For more information, see...
Speed dial a number	Do one of the following: <ul style="list-style-type: none"> • Press , choose a speed-dial number, and press Dial. • Press  and select Directories > Speed Dials. Select a number and press Dial. • Use the Abbreviated Dial feature. • Use the Fast Dial feature. 	Speed Dialing, page 27.
Dial from a corporate directory on your phone	<ol style="list-style-type: none"> 1. Press  and select Directories > Corporate Directory (name can vary). 2. Enter a name and press Search. 3. Highlight a listing and go off-hook. 	Using Call Logs, page 43.
Dial from a corporate directory on your personal computer using Cisco WebDialer	<ol style="list-style-type: none"> 1. Open a web browser and go to a WebDialer-enabled corporate directory. 2. Click the number that you want to dial. 	Using Cisco WebDialer, page 59.
Use Cisco CallBack to receive notification when a busy or ringing extension is available	<ol style="list-style-type: none"> 1. Press CallBack while listening to the busy tone or ring sound. 2. Hang up. Your phone alerts you when the line is free. 3. Place the call again. 	Your system administrator.
Make a priority (precedence) call (SCCP phones only)	Enter the Multilevel Precedence and Preemption (MLPP) access number, then enter a phone number.	Prioritizing Critical Calls, page 33.
Dial from a Personal Address Book (PAB) entry	<ol style="list-style-type: none"> 1. Press  and select Directories > Personal Directory to log in. 2. Choose Personal Address Book and search for a listing. 	Using the User Options Web Pages, page 50. Using Personal Directory on Your Phone, page 46.

If you want to...	Then...	For more information, see...
Place a call using a billing or tracking code (SCCP phones only)	<ol style="list-style-type: none"> 1. Dial a number. 2. After the tone, enter a client matter code (CMC) or a forced authorization code (FAC). 	Your system administrator.
Place a call using your Cisco Extension Mobility profile	Log in to the Cisco Extension Mobility service on a phone.	Using Cisco Extension Mobility, page 35.
Make a call from a cellular phone using Mobile Voice Access	<ol style="list-style-type: none"> 1. Obtain your Mobile Voice Access number and End user PIN from your system administrator. 2. Dial your assigned Mobile Voice access number. 3. Enter your cellular phone number (if requested) and PIN. 4. Press 1 to make a call to an enterprise IP phone. 5. Dial a desktop phone number other than your desktop phone number. 	Managing Business Calls Using a Single Phone Number, page 35.
Place a call using Fast Dial	<p>Note Before using this option, your system administrator must configure this feature and assign a service URL to the line button. Contact your system administrator for more information.</p> <ol style="list-style-type: none"> 1. Press the Fast Dial line button. 2. Scroll to or press the index number to find and select an entry. <p>The system dials the specified number.</p>	Configuring Fast Dials on the Web, page 52 Using Your Personal Address Book on the Web, page 51
Place a call using your PAB	<p>Note Before using this option, your system administrator must configure this feature and assign a service URL to the line button. Contact your system administrator for more information.</p> <ol style="list-style-type: none"> 1. Press the PAB line button. 2. Access the contact and select the number. <p>The system dials the specified number.</p>	Configuring Fast Dials on the Web, page 52 Using Your Personal Address Book on the Web, page 51

Answering a Call

You can answer a call by simply lifting the handset, or you can use other options if they are available on your phone.

If you want to...	Then...	For more information, see...
Switch from a connected call to answer a new call	Press Answer .	Using Hold and Resume, page 18.
Answer a call using call waiting	Press Answer .	Using Hold and Resume, page 18.
Send a call to a voice message system	Press iDivert .	Sending a Call to a Voice Message System, page 21.
Automatically connect incoming calls	Use AutoAnswer.	Using AutoAnswer, page 40.
Retrieve a parked call on another phone	Use Call Park or Directed Call Park.	Storing and Retrieving Parked Calls, page 29.
Use your phone to answer a call ringing elsewhere	Use Call Pickup.	Picking Up a Redirected Call on Your Phone, page 28.
Answer a priority call (SCCP phones only)	Hang up the current call and press Answer .	Prioritizing Critical Calls, page 33.
Answer a call on your cellular phone or other remote destination	Set up Mobile Connect and answer your phone. When you enable Mobile Connect: <ul style="list-style-type: none"> • Your desktop and remote destinations receive calls simultaneously. • When you answer the call on your desktop phone, the remote destinations stop ringing, are disconnected, and display a missed call message. • When you answer the call on one remote destination, the other remote destinations stop ringing, are disconnected, and a missed call message is shown on the other remote destinations. 	Managing Business Calls Using a Single Phone Number, page 35.

Tip

If parties on a call hear a beep tone, the call might be monitored or recorded. Ask your system administrator for more information.

Ending a Call

To end a call, simply hang up. Here are some more details.

If you want to...	Then...
Hang up while using the handset	Return the handset to its cradle. Or press EndCall .
Hang up while monitoring a call (using the speaker)	Press EndCall .
Hang up one call, but preserve another call on the same line	Press EndCall . If necessary, remove the call from hold first.



Using Hold and Resume

You can hold and resume calls. When you put a call on hold, the Hold icon  appears next to the call timer and in the line area. When using a shared line and another phone user puts the call on hold, the Remote Hold icon appears next to the call timer and in the line area. In both cases, the hold LED is solid red.

If the Hold Reversion feature is enabled for your phone, a call that you put on hold reverts back to ringing after a certain period of time. The “reverting” calls remains on hold until you resume it or until Hold Reversion times out.

Your phone indicates the presence of a reverting call by:

- Alerting you at intervals with a single ring (or flash or beep, depending on your phone line setting).
- Briefly displaying a “Hold Reversion” message in the status bar at the bottom of the phone screen.
- Displaying the animated Hold Reversion icon  next to the caller ID for the held call.

If you want to...	Then...
Put a call on hold	<ol style="list-style-type: none">1. Make sure the call you want to put on hold is highlighted.2. Press .
Remove a call from hold	<ol style="list-style-type: none">1. Make sure the appropriate call is highlighted.2. Press .

Tips

- Engaging the Hold feature typically generates music or a beeping tone.

- When a held call is highlighted, the Hold button  becomes lit (red). When a call that is not held is highlighted, and there are other held calls on the line, the Hold button changes to blinking (red).
- If you receive an alert for an incoming call and a reverting call at the same time, by default your phone will shift the focus of the phone screen to display the incoming call. Your system administrator can change this focus priority setting.
- If you use a shared line, Hold Reversion rings only on the phone that put the call on hold, not on the other phones that share the line.
- The duration between Hold Reversion alerts is determined by your system administrator.

Switching Between Multiple Calls

You can switch between multiple calls on your phone.

If you want to...	Then...
Switch between connected calls	<ol style="list-style-type: none"> 1. Make sure the call that you want to switch to is highlighted. 2. Press . Any active call is placed on hold and the selected call is resumed.
Switch from a connected call to answer a ringing call	Press Answer . Any active call is placed on hold.

Switching an In-Progress Call to Another Phone

You can switch in-progress calls between the desktop phone and your cellular phone or other remote destination.

If you want to...	Then...
Switch an in-progress call on your desktop phone to a cellular phone	<ol style="list-style-type: none"> 1. Press the Mobility softkey and select Send call to mobile. 2. Answer the in-progress call on your cellular phone.
Switch an in-progress call from a cellular phone to your desktop phone	<ol style="list-style-type: none"> 1. Hang up the call on your cellular phone to disconnect the cellular phone, but not the call. 2. Press Resume on your desk phone within 4 seconds and start talking on the desk phone.

Viewing Multiple Calls

Understanding how multiple calls are displayed on your phone can help you organize your call-handling efforts.

Your phone displays calls as follows for the highlighted line:

- Calls with the highest precedence and longest duration display at the top of the list.
- Calls of a similar type are grouped together. For example, calls that you have interacted with are grouped near the top, and calls on hold are grouped last.

Transferring Calls

Transfer redirects a connected call. The *target* is the number to which you want to transfer the call.

If you want to...	Then...
Transfer a call without talking to the transfer recipient	<ol style="list-style-type: none">1. From an active call, press Transfer.2. Enter the target number.3. Press Transfer again to complete the transfer or EndCall to cancel. <p>Note If your phone has on-hook transfer enabled, complete the transfer by hanging up.</p>
Talk to the transfer recipient before transferring a call (consult transfer)	<ol style="list-style-type: none">1. From an active call, press Transfer.2. Enter the target number.3. Wait for the transfer recipient to answer.4. Press Transfer again to complete the transfer or EndCall to cancel. <p>Note If your phone has on-hook transfer enabled, complete the transfer by hanging up.</p>
Transfer two current calls to each other (direct transfer) without staying on the line (SCCP phones only)	<ol style="list-style-type: none">1. Scroll to highlight any call on the line.2. Press Select.3. Repeat this process for the second call.4. With one of the selected calls highlighted, press DirTrfr. (To display DirTrfr, you might need to press more.) <p>The two calls connect to each other and drop you from the call.</p> <p>Note If you want to stay on the line with the callers, use Join instead.</p>
Redirect a call to a voice message system	Press iDivert . For more information, see Sending a Call to a Voice Message System, page 21 .

Tips

- If on-hook transfer is enabled on your phone, you can either hang up to complete the call, or press **Transfer** and then hang up.
- If on-hook transfer is *not* enabled on your phone, hanging up without pressing **Transfer** again places the call on hold.

- You cannot use **Transfer** to redirect a call on hold. Press  again to remove the call from hold before transferring it.

Sending a Call to a Voice Message System

You can use **iDivert** to send an active, ringing, or on-hold call to your voice message system. Depending on the type of call and your phone configuration, you can also use **iDivert** to send the call to another party's voice message system.

- If the call was originally sent to someone else's phone, **iDivert** allows you to redirect the call either to your own voice message system or to the original called party's voice message system. Your system administrator must make this option available to you.
- If the call was sent to you directly (not transferred or forwarded to you), or if your phone does not support the option described above, using **iDivert** redirects the call to your voice message system.

If you want to...	Then...
Send an active, ringing, or on-hold call to a voice message system	Press iDivert . One of two things occurs: <ul style="list-style-type: none"> The call is transferred to your voice message system. Your phone screen displays a menu that allows you to choose between your voice message system or the voice message system of the original called party. Choose an option to redirect the call.

Tip

If your phone displays a menu that disappears before you make your selection, you can press **iDivert** again to re-display the menu. You can also ask your system administrator to configure a longer timeout value.

Forwarding Calls to Another Number

You can use the call forwarding features to redirect incoming calls from your phone to another number.

Your system administrator might allow you to choose from two types of call forwarding features:

- Unconditional call forwarding (Call Forward All)—Applies to all calls that you receive.
- Conditional call forwarding (Call Forward No Answer, Call Forward Busy, Call Forward No Coverage)—Applies to certain calls that you receive, according to conditions.

You can access Call Forward All on your phone; other call forwarding features are accessible only on your User Options web pages. Your system administrator determines which call forwarding features are available to you.

If you want to...	Then...
Set up Call Forward All on your line	Press CFwdALL and enter a target phone number.
Cancel Call Forward All on your line	Press CFwdALL .
Verify that Call Forward All is enabled on your line	Look for: <ul style="list-style-type: none"> • Alternating call forwarding icons  displayed next to your phone number. • The call forward target number in the status line.
Set up or cancel call forwarding remotely	<ol style="list-style-type: none"> 1. Log in to your User Options web pages. (See Accessing Your User Options Web Pages, page 50.) 2. Access your call forwarding settings. (See Controlling Line Settings on the Web, page 56.)

Tips

- Enter the call forward target number exactly as you would dial it from your phone. For example, enter an access code or the area code, if necessary.
- You can forward your calls to a traditional analog phone or to another IP phone, although your system administrator might restrict the call forwarding feature to numbers within your company.
- Call forwarding is phone line specific. If a call reaches you on a line where call forwarding is not enabled, the call will ring as usual.
- Your system administrator can enable a call forward override feature that allows the person receiving your forwarded calls to reach you. With override enabled, a call placed from the target phone to your phone is not forwarded, but rings through.

Using Do Not Disturb

You can use Do Not Disturb (DND) to block incoming calls from ringing on your phone. Your system administrator enables DND for your phone.

When DND and Call Forward are both enabled on your phone, calls are forwarded and the caller does not hear a busy tone.

If you want to...	Then...
Turn on DND	Press DND . “Do Not Disturb” displays on the status line, and the ring tone is turned off.
Turn off DND	Press the DND softkey or: <ol style="list-style-type: none"> 1. Press  > Device Configuration > Call Preferences > Do Not Disturb. 2. Select No, and then press Save.
Customize DND settings	<ol style="list-style-type: none"> 1. Log in to your User Options web pages. See Accessing Your User Options Web Pages, page 50. 2. From the drop-down menu, choose User Options > Device. 3. You can set the following options: <ul style="list-style-type: none"> – Do Not Disturb—Set to enable/disable DND. – DND Incoming Call Alert—Set the alert to beep only or disable all visible and audible alert notifications.

Making Conference Calls

Your Cisco Unified IP Phone allows you to talk simultaneously with multiple parties in a conference call.

Using Conference Features

You can create a conference in various ways, depending on your needs and the features that are available on your phone.

- **Conference**—Allows you to create a standard (ad hoc) conference by calling each participant. Use the **Conf rn** softkey. Conference is available on most phones.
- **Join**—Allows you to create a standard (ad hoc) conference by combining existing calls. Use the **Join** softkey. Join is available on SCCP phones only.
- **cBarge**—Allows you to create a standard (ad hoc) conference by adding yourself to a call on a shared line. Use the **cBarge** softkey. cBarge is only available on phones that use shared lines.
- **Meet-Me**—Allows you to create or join a conference by calling a conference number. Use the **MeetMe** softkey.

Using Conference

Conference allows you to call each participant. Conference is available on most phones.

If you want to...	Then...
Create a conference by calling participants	<ol style="list-style-type: none">1. From a connected call, press Confrn.2. Enter the participant's phone number.3. Wait for the call to connect.4. Press Confrn again to add the participant to your call.5. Repeat to add additional participants.
Add new participants to an existing conference	Repeat the steps listed above. Your system administrator determines whether non-initiators of a conference can add or remove participants.
See a list of participants or remove participants	See Viewing or Removing Conference Participants, page 26 .

Using Join

(SCCP phones only)

Join allows you to combine two or more existing calls to create a conference in which you are a participant.

If you want to...	Then...
Create a conference by joining together existing calls	<ol style="list-style-type: none">1. From an active call, highlight another call that you want to include in the conference and press Select. Selected calls display this icon .2. Repeat this step for each call that you want to add.3. Press Join. (You may need to press the more softkey to see Join.)
Join together two existing conferences	Use the Join or DirTrfr softkeys. Check with your system administrator to see if this feature is available to you.
See a list of participants or remove participants	See Viewing or Removing Conference Participants, page 26 .

Using cBarge

You can create a conference by using cBarge to add yourself to a call on a shared line.

If you want to...	Then...
Create a conference by barging a call on a shared line	Highlight the call and press cBarge to complete the action. See Using a Shared Line, page 30 for more information.
See a list of participants or remove participants	See Viewing or Removing Conference Participants, page 26 .

Using Meet-Me

Meet-Me conferencing allows you to start or join a conference by calling the conference number.





If you want to...	Then...
Start a Meet-Me conference	<ol style="list-style-type: none"> 1. Obtain a Meet-Me phone number from your system administrator. 2. Distribute the number to participants. 3. When you are ready to start the meeting, go off-hook to get a dial tone, then press MeetMe. 4. Dial the Meet-Me conference number. Participants can now join the conference by dialing in. <p>Note Participants hear a busy tone if they call the conference before the initiator has joined. In this case, participants must call back.</p>
Join a Meet-Me conference	<p>Dial the Meet-Me conference number (provided by the conference initiator).</p> <p>Note You will hear a busy tone if you call the conference before the initiator has joined. In this case, try your call again.</p>
End a Meet-Me conference	<p>All participants must hang up.</p> <p>The conference does not automatically end when the conference initiator disconnects.</p>

Tip

If you call a secure Meet-Me conference number from a non-secure phone, your phone displays the message, “Device Not Authorized.” For more information, see [Making and Receiving Secure Calls, page 32](#).

Viewing or Removing Conference Participants

During a standard (ad hoc) conference, you can view a list of participants and remove participants.

View a list of conference participants	Press ConfList . Participants are listed in the order in which they join the conference with the most recent additions at the top.
Get an updated list of conference participants	While viewing the conference list, press Update .
See who initiated the conference	While viewing the conference list, locate the participant listed at the bottom of the list with an asterisk (*) next to the name.
Remove any conference participant	While viewing the conference list, highlight the participant's name and press Remove .
Drop the last participant added to the conference	While viewing the conference list, press RMLstC . You can remove participants only if you initiated the conference call.
Verify that a conference call is secure	Look for the  or  icon after "Conference" on the phone screen.
Verify that a participant is calling from a secure phone	Look for the  or  icon beside the participant's name on the phone screen.
Add more participants	See Using Conference, page 24 .

Advanced Call Handling

Advanced call-handling tasks involve special features that your system administrator might configure for your phone depending on your call-handling needs and work environment.

Speed Dialing



Speed dialing allows you to enter an index number or select a phone screen item to place a call. Depending on configuration, your phone can support several speed-dial features:

- Speed Dials
- Abbreviated Dialing
- Fast Dials



Note

- To set up speed-dial numbers and Abbreviated Dial, you must be able to access your User Options web pages. See [Using the User Options Web Pages, page 50](#).
- To set up Fast Dials, you must have access to the Personal Directory feature. See [Using Personal Directory on Your Phone, page 46](#).
- Alternately, your system administrator can configure speed-dial features for you.

If you want to...	Then...
Use Speed Dials	<ol style="list-style-type: none"> 1. Set up speed-dial numbers. See Setting Up Speed Dials on the Web, page 53. 2. To place a call, press , or press  and select Directories > Speed Dials.
Use Abbreviated Dial	<ol style="list-style-type: none"> 1. Set up Abbreviated Dialing codes. See Setting Up Speed Dials on the Web, page 53. 2. To place a call, enter the Abbreviated Dialing code and press AbbrDial.
Use Fast Dial	<ol style="list-style-type: none"> 1. Create a Personal Address Book entry and assign a Fast Dial code. See Using Personal Directory on the Web, page 51. 2. To place a call, access the Fast Dial service on your phone. See Using Personal Directory on Your Phone, page 46.

Picking Up a Redirected Call on Your Phone

Call PickUp allows you to answer a call that is ringing on a co-worker's phone by redirecting the call to your phone. You might use Call PickUp if you share call-handling with coworkers.

If you want to...	Then...
Answer a call that is ringing on another extension within your call pickup group	<ol style="list-style-type: none">1. Do one of the following:<ul style="list-style-type: none">- If the PickUp softkey is available, press it.- If the PickUp softkey is not available, go off-hook to display it, then press PickUp.If your phone supports auto-pickup, you are now connected to the call.2. If the call rings, press Answer to connect to the call.
Answer a call that is ringing on another extension outside of your group	<ol style="list-style-type: none">1. Do one of the following:<ul style="list-style-type: none">- If the GPickUp softkey is available, press it.- If the GPickUp softkey is not available, go off-hook to display it, then press GPickUp.2. Enter the group pickup code. If your phone supports auto-pickup, you are now connected to the call.3. If the call rings, press Answer to connect to the call.
Answer a call that is ringing on another extension in your group or in an associated group	<ol style="list-style-type: none">1. Do one of the following:<ul style="list-style-type: none">- If the OPickUp softkey is available, press it.- If the OPickUp softkey is not available, go off-hook to display it, then press OPickUp.If your phone supports auto-pickup, you are now connected to the call.2. If the call rings, press Answer to connect to the call.

Tips

- Depending on how your phone is configured, you might receive an audio and/or visual alert about a call to your pickup group.
- Pressing **PickUp** and **GPickUp** connects you to the call that has been ringing for the longest time.
- Pressing **OPickUp** connects you to the call in the pickup group with the highest priority.

Storing and Retrieving Parked Calls

You can park a call when you want to store the call so that you or someone else can retrieve it from another phone in the Cisco Unified Communications Manager system (for example, a phone at a co-worker's desk or in a conference room). You can park a call by using these methods:

- **Call Park**—Use the **Park** softkey to store the call. Your phone displays the call park number where the system stored your call. You must record this number and then use the same number to retrieve the call.
- **Directed Call Park**—Use the **Transfer** softkey to direct the call to an available directed call park number that you dial or speed dial. To retrieve the call from a directed call park number, you must dial the park retrieval prefix and then dial or speed dial the same directed call park number.

If you want to...	Then...
Store an active call using Call Park	<ol style="list-style-type: none"> 1. During a call, press Park. (You may need to press the more softkey to see Park.) 2. Record the call park number displayed on your phone screen. 3. Hang up.
Retrieve a parked call	Enter the call park number from any Cisco Unified IP Phone in your network to connect to the call.
Direct and store an active call at a directed call park number	<ol style="list-style-type: none"> 1. During a call, press Transfer. 2. Select a speed-dial number assigned to a directed call park number or dial the number. 3. Press Transfer again to finish storing the number.
Retrieve a parked call from a directed call park number	Cisco Unified IP Phone in your network, enter the park retrieval prefix and dial the directed call park number, or after entering the park retrieval prefix, select the speed-dial for the directed call park number to connect to the call.

Tip

You have a limited time to retrieve a parked call before it reverts to ringing at the original number. See your system administrator for details.

Logging Out of Hunt Groups

If your organization receives a large number of incoming calls, you might be a member of a hunt group. A hunt group includes a series of directory numbers that share the incoming call load. When the first directory number in the hunt group is busy, the system hunts for the next available directory number in the group and directs the call to that phone.

When you are away from your phone, you can prevent hunt group calls from ringing your phone by logging out of hunt groups.

If you want to...	Then...
Log out of hunt groups to temporarily block hunt group calls	Press HLog . Your phone screen displays, “Logged out of Hunt Group.”
Log in to receive hunt group calls	Press HLog .

Tip

Logging out of hunt groups does not prevent non-hunt group calls from ringing your phone.

Using a Shared Line

Your system administrator might ask you to use a shared line if you:

- Have multiple phones and want one phone number
- Share call-handling tasks with coworkers
- Handle calls on behalf of a manager

Understanding Shared Lines

Remote-in-Use Icon

The remote-in-use icon  appears when another phone that shares your line has a connected call. You can place and receive calls as usual on the shared line, even when the remote-in-use icon appears.

Sharing Call Information and Barging

Phones that share a line each display information about calls that are placed and received on the shared line. This information might include caller ID and call duration. (See [Privacy, page 30](#) for exceptions.)

When call information is visible in this way, you and coworkers who share a line can add yourselves to calls using either **Barge** or **cBarge**. See [Using Barge to Add Yourself to a Shared-Line Call, page 31](#).

Privacy

If you do not want coworkers who share your line to see information about your calls, enable the Privacy feature. Doing so also prevents coworkers from barging your calls. See [Preventing Others from Viewing or Barging a Shared-Line Call, page 32](#).

**Note**

The maximum number of calls that a shared line supports can vary by phone.

Using Barge to Add Yourself to a Shared-Line Call

You can use barge features (cBarge and Barge) to add yourself to calls on your shared line. (Calls must be non-private calls. See [Using a Shared Line, page 30.](#))

Understanding Barge Features

cBarge and Barge

Depending on how your phone is configured, you can add yourself to a call on a shared line using either cBarge or Barge:

- cBarge converts the call into a standard conference, allowing you to add new participants. (See [Making Conference Calls, page 23](#) for information about standard conferences.)
- Barge allows you to add yourself to the call but does not convert the call into a conference or allow you to add new participants.

Using Barge Features

The table below describes how to use barge features (cBarge or Barge) to add yourself to a call on a shared line.

If you want to...	Then...
See if the shared line is in use	Look for the remote-in-use icon  .
Add yourself to a call on a shared line	<ol style="list-style-type: none"> 1. Highlight a remote-in-use call. 2. Press Barge. (You may need to press the more softkey to display Barge.) Other parties hear a beep tone announcing your presence.
View conference participants (if you used cBarge)	See Viewing or Removing Conference Participants, page 26.



Tips

- When you barge a call, other parties might hear a beep tone announcing your presence. With cBarge, other parties hear a brief audio interruption and the phone screen changes to display conference details.
- If a phone that is using the shared line has Privacy enabled, call information and barge softkeys will not appear on the other phones that share the line.

- If a phone that is using the shared line has Privacy disabled and it is configured with Private Line Automated Ringdown (PLAR), the barge and cBarge features will still be available.
- You will be disconnected from a call that you have joined using **Barge** if the call is put on hold, transferred, or turned into a conference call.

Preventing Others from Viewing or Barging a Shared-Line Call

If you share a phone line, you can use the Privacy feature to prevent others who share the line from viewing or barging (adding themselves to) your calls.

If you want to...	Then...
Prevent others from viewing or barging calls on a shared line	<ol style="list-style-type: none"> 1. Press more > Private. 2. To verify that Privacy is on, look for the Privacy-enabled icon  next to “Private” on the phone screen.
Allow others to view or barge calls on a shared line	<ol style="list-style-type: none"> 1. Press more > Private. 2. To verify that Privacy is off, look for the Privacy-disabled icon  next to “Private” on the phone screen.

Tip



If the phone that shares your line has Privacy enabled, you can make and receive calls using the shared line as usual.

Making and Receiving Secure Calls

Depending on how your system administrator has configured your phone system, your phone might support making and receiving secure calls.

Your phone can support these types of calls:

- *Authenticated* call—The identities of all phones participating in the call have been verified.
- *Encrypted* call—The phone is receiving and transmitting encrypted audio (your conversation) within the Cisco IP network. Encrypted calls are also authenticated.
- *Non-secure* call—At least one of the participating phones or the connection does not support these security features, or the phones cannot be verified.

If you want to...	Then...
Check the security level of a call or conference	Look for a security icon in the top right corner of the call activity area, next to the call duration timer: <ul style="list-style-type: none">  Authenticated call or conference  Encrypted call or conference  Non-secure call or conference
Determine if secure calls can be made in your company	Contact your system administrator.

**Note**

There are interactions, restrictions, and limitations that affect how security features work on your phone. For more information, ask your system administrator.

Tracing Suspicious Calls

(SCCP phones only)

If you are receiving suspicious or malicious calls, your system administrator can add the Malicious Call Identification (MCID) feature to your phone. This feature enables you to identify an active call as suspicious, which initiates a series of automated tracking and notification messages.

If you want to...	Then...
Notify your system administrator about a suspicious or harassing call	Press MCID . Your phone plays a tone and displays the message, “MCID successful.”

Prioritizing Critical Calls

(SCCP phones only)

In some specialized environments, such as military or government offices, you might need to make and receive urgent or critical calls. If you have the need for this specialized call handling, your system administrator can add Multilevel Precedence and Preemption (MLPP) to your phone.

Keep these terms in mind:

- *Precedence* indicates the priority associated with a call.

- *Preemption* is the process of ending an existing, lower priority call while accepting a higher priority call that is sent to your phone.



If you...	Then...
Want to choose a priority (precedence) level for an outgoing call	Contact your system administrator for a list of corresponding precedence numbers for calls.
Want to make a priority (precedence) call	Enter the MLPP access number (provided by your system administrator) followed by the phone number.
Hear a special ring (faster than usual) or special call waiting tone	You are receiving a priority (precedence) call. An MLPP icon on your phone screen indicates the priority level of the call.
Want to view priority level of a call	<p>Look for an MLPP icon on your phone screen:</p> <ul style="list-style-type: none"> ▪ Priority call ▣ Medium priority (immediate) call ▣▣ High priority (flash) call ▣▣▣ Highest priority (flash override) or Executive Override call <p>Higher priority calls are displayed at the top of your call list. If you do not see an MLPP icon, the priority level of the call is normal (routine).</p>
Want to accept a higher-priority call	Answer the call as usual. If necessary, end an active call first.
Hear a continuous tone interrupting your call	You or the other party are receiving a call that must preempt the current call. Hang up immediately to allow the higher priority call to ring through.

Tips

- When you make or receive an MLPP-enabled call, you will hear special ring tones and call waiting tones that differ from the standard tones.
- If you enter an invalid MLPP access number, a verbal announcement will alert you of the error.
- An MLPP-enabled call retains its priority and preemptive status when you:
 - Put the call on hold
 - Transfer the call
 - Add the call to a three-way conference
 - Answer the call using PickUp
- MLPP overrides the Do Not Disturb (DND) feature.

Using Cisco Extension Mobility

Cisco Extension Mobility (EM) allows you to temporarily configure a Cisco Unified IP Phone as your own. Once you log in to EM, the phone adopts your user profile, including your phone lines, features, established services, and web-based settings. Your system administrator must configure EM for you.

If you want to...	Then...
Log in to EM	<ol style="list-style-type: none"> 1. Press  and choose Services > EM Service (name can vary). 2. Enter your user ID and PIN (provided by your system administrator). 3. If prompted, select a device profile.
Log out of EM	<ol style="list-style-type: none"> 1. Press  and choose Services > EM Service (name can vary). 2. When prompted to log out, press Yes.

Tips

- EM automatically logs you out after a certain amount of time. Your system administrator establishes this time limit.
- Changes that you make to your EM profile from your User Options web pages take effect immediately if you are logged in to EM on the phone; otherwise, changes take effect the next time you log in.
- Changes that you make to the phone from your User Options web pages take effect immediately if you are logged out of EM; otherwise, changes take effect after you log out.
- Local settings controlled by the phone are not maintained in your EM profile.

Managing Business Calls Using a Single Phone Number

With Mobile Connect and Mobile Voice Access installed, you can use your cellular phone to handle calls associated with your desktop phone number. A *smartphone* is a mobile phone with personal computer capabilities such as web browsing, email, address book, and calendar.

If you want to...	Then...
Configure Mobile Connect	Use the User Options web pages to set up remote destinations and create access lists to allow or block calls from specific phone numbers from being passed to the remote destinations. See Setting Up Phones and Access Lists for Mobile Connect , page 58.
Answer a call using your cellular phone	See Answering a Call , page 17.
Switch an in-progress call between your desk phone and cellular phone	See Switching an In-Progress Call to Another Phone , page 19.

If you want to...	Then...
Put a call that has been picked up on a smartphone on hold	<ol style="list-style-type: none"> 1. Press the <i>Enterprise Hold</i> (name may vary) softkey on the smartphone. The other party is placed on hold. 2. On your smartphone, press the <i>Resume Softkey</i> (name may vary). See Switching an In-Progress Call to Another Phone, page 19.
Transfer a call that has been picked up on a smartphone to another number	<ol style="list-style-type: none"> 1. Press the <i>Enterprise Transfer</i> (name may vary) softkey on the smartphone. 2. Dial your enterprise access code for transferring calls to initiate a new call. The other party is placed on hold. 3. Press the <i>Enterprise Transfer</i> softkey to complete the call transfer.
Initiate a conference call on a call that has been picked up on a smartphone	<ol style="list-style-type: none"> 1. Press the <i>Enterprise Conference</i> (name may vary) softkey on the smartphone. 2. Dial your enterprise access code for conferencing to initiate a new call. The other party is placed on hold. 3. Press the <i>Enterprise Conference</i> softkey to complete the conference set-up and include both callers in the conference.
Connect to Mobile Voice Access	<ol style="list-style-type: none"> 1. From any phone, dial your assigned Mobile Voice Access number. 2. Enter the number you are calling from, if prompted, and your PIN.
Turn on Mobile Connect from your cellular phone	<ol style="list-style-type: none"> 1. Dial your assigned Mobile Voice access number. 2. Enter your cellular phone number (if requested) and PIN. 3. Press 2 to enable Mobile Connect. 4. Choose whether to turn Mobile Connect on for all configured phones or just one: <ul style="list-style-type: none"> – All phones—Enter 2. – One phone—Enter 1 and enter the number you want to add as a remote destination, followed by #.

If you want to...	Then...
Make a call from your cellular phone	See Placing a Call—Additional Options, page 15 .
Turn off Mobile Connect from your cellular phone	<ol style="list-style-type: none"> 1. Dial your assigned Mobile Voice access number. 2. Enter your cellular phone number (if requested) and PIN. 3. Press 3 to disable Mobile Connect. 4. Choose whether to turn Mobile Connect off for all configured phones or just one: <ul style="list-style-type: none"> – All phones—Enter 2. – One phone—Enter 1 and enter the number you want to remove as a remote destination, followed by #.

Tips

- When calling Mobile Voice Access, you need to enter the number you are call from in addition to the PIN if any of the following are true:
 - The number you are calling from is not one of your remote destinations.
 - The number is blocked by you or your carrier (shown as “Unknown Number”).
 - The number is not accurately matched in the Cisco Unified Communications Manager database; for example, if your number is 510-666-9999, but it is listed as 666-9999 in the database, or your number is 408-999-6666, but it is entered as 1-408-999-6666 in the database.
- If you incorrectly enter any requested information (such as cellular phone number or PIN) three times in a row, the Mobile Voice Access call disconnects, and you are locked out for a period of time. Contact your system administrator if you need assistance.

Using a Handset, Headset, and Speaker

The Cisco Unified IP Phone 7906G and 7911G provide a speaker for hands-free listening. You can use the speaker only to listen to a call. To talk on a call, you must use the handset.

You can use the speaker in one of two ways, depending on how your system administrator enables the phone. Your phone may be enabled for one of the following features, but not both at the same time:

- Group Listen
- Monitor (default)

Using the Group Listen Feature

The following table shows how you can use the Group Listen feature.

If you want to...	Then...
Use the handset	Lift it to go off-hook; replace it to go on-hook.
Talk using the handset and listen on the speaker at the same time (Group Listen)	Press GListen . Note Group Listen must be enabled by your system administrator for the GListen softkey to display.
Turn off Group Listen and use the handset	Press GLOff .
Hang up after using Group Listen	Press EndCall or hang up.
Adjust the volume level for a call	Note When using Group Listen, adjusting the volume only changes the volume for the speaker and not the handset. Press the up or down Volume button during a call or after invoking a dial tone. Press Save to preserve the volume level for future calls.

Using the Monitor Feature

The following table shows how you can use the Monitor feature.

If you want to...	Then...
Use the handset	Lift it to go off-hook; replace it to go on-hook.
Listen to the call on the speaker	Press Monitor and then hang up the handset. You will be able to hear the call but you will not be able to talk on the call. Note The Monitor and MonOff softkeys are not available if Group Listen is enabled.
Turn off the speaker and use the handset	Lift the handset, or press MonOff . Note The Monitor and MonOff softkeys are not available if Group Listen is enabled.
Turn off the speaker and hang up	Press EndCall .
Adjust the speaker volume level for a call	Press the up or down Volume button during a call or after invoking a dial tone. Press Save to preserve the volume level for future calls.

Tips

- If your system administrator has disabled the speaker on your phone, the **GListen**, **GLOff**, **Monitor**, and **MonOff** softkeys will not be available to you. You must lift the handset to place and monitor calls.
- Pressing the **Volume** button changes the volume for the handset or speaker, depending on which device is in use. In Group Listen and Monitor modes, the volume adjustment is for the speaker and not the handset.



Note

If you need to change the wideband setting for your handset (for example, if you change your handset) press  and choose **Settings > User Preferences > Audio Preferences > Wideband Handset**. If the Wideband Handset setting shows as dimmed, then this setting is not user controllable.

Check with your system administrator to be sure your phone system is configured to use wideband. If the system is not configured for wideband, you may not detect any additional audio sensitivity even when using a wideband handset. To learn more, refer to the handset documentation or ask your system administrator for assistance.

Using and Obtaining a Headset

To use a headset, disconnect the handset and connect a headset to the Handset port.

If you connect a headset to the handset port, be sure that the Wideband Handset setting is disabled. Choose **User Preferences > Audio Preferences > Wideband Handset**.



Note If the Wideband Handset setting shows as dimmed, then this setting is not user controllable and you must contact your system administrator to change this setting.

For information about purchasing headsets, see [Headset Information, page 7](#). Depending on headset manufacturer's recommendations, an external amplifier may be required. Refer to headset manufacturer's product documentation for more information.

Using AutoAnswer

When AutoAnswer is enabled, your phone answers incoming calls automatically after a few rings. Your system administrator can configure AutoAnswer to use the speaker to answer calls. However, you can only monitor the call using the speaker. To talk to the caller, you must pick up the handset.



Tip AutoAnswer is disabled when Do Not Disturb is active.

Changing Phone Settings

You can personalize your Cisco Unified IP Phone by adjusting the ring tone, background image, and other settings.

Customizing Rings and Message Indicators

You can customize how your phone indicates an incoming call and a new voice message. You can also adjust the ringer volume for your phone.

If you want to...	Then...
Change the ring tone	<ol style="list-style-type: none"> 1. Press  and select Settings > User Preferences > Rings. 2. Select a ring tone and press Play to hear a sample. 3. Press Save to set the ring tone, or press Cancel.
Change the ring pattern (flash-only, ring once, beep-only, etc.)	<p>Log in to your User Options web pages. (See the Accessing Your User Options Web Pages, page 50.)</p> <ol style="list-style-type: none"> 1. Log in to your User Options web pages. (See Accessing Your User Options Web Pages, page 50.) 2. Access your call ring pattern settings. (See Controlling Line Settings on the Web, page 56.) <p>Note Before you can access this setting, your system administrator might need to enable it for you.</p>
Adjust the volume level for the phone ringer	Press the Volume button while the handset is in the cradle. The new ringer volume is saved automatically.
Change the way that the voice message light on your handset works	<ol style="list-style-type: none"> 1. Log in to your User Options web pages. (See the Accessing Your User Options Web Pages, page 50.) 2. Choose Change the Message Waiting Lamp policy... 3. Access your message indicator settings. (See Controlling Line Settings on the Web, page 56.) <p>Note Typically, the default system policy is to indicate a new voice message by displaying a steady light on the handset light strip.</p>

Customizing the Phone Screen

You can adjust the characteristics of the phone screen.





If you want to...	Then...
Change the background image	<ol style="list-style-type: none"><li data-bbox="392 337 1163 391">1. Press  and choose Settings > User Preferences > Background Images.<li data-bbox="392 407 1204 435">2. Scroll through available images and press Select to choose an image.<li data-bbox="392 451 1116 479">3. Press Preview to see a larger view of the background image.<li data-bbox="392 495 915 522">4. Press Exit to return to the selection menu.<li data-bbox="392 539 1029 566">5. Press Save to accept the new image, or press Cancel.
Change the language on the phone screen	<ol style="list-style-type: none"><li data-bbox="392 576 1190 634">1. Log in to your User Options web pages. (See Accessing Your User Options Web Pages, page 50.)<li data-bbox="392 651 1204 709">2. Access your user settings. (See Controlling User Settings on the Web, page 56.)
Change the line text label	<ol style="list-style-type: none"><li data-bbox="392 722 1190 781">1. Log in to your User Options web pages. (See Accessing Your User Options Web Pages, page 50.)<li data-bbox="392 797 1204 855">2. Access your line text label settings. (See Controlling Line Settings on the Web, page 56.)





Using Call Logs and Directories

This section describes how you can use call logs and directories. To access both features, press  and select **Directories**.

Using Call Logs

Your phone maintains logs of your missed, placed, and received calls. Your phone administrator determines whether missed calls are logged in your missed calls directory for a given line appearance on your phone.

If you want to...	Then...
View your call logs	Press  , and choose Directories > Missed Calls, Placed Calls, or Received Calls . Each stores up to 100 records. To view a truncated listing, highlight it and press EditDial .
Display details for a single call record	<ol style="list-style-type: none"> 1. Press , choose Directories > Missed Calls, Placed Calls, or Received Calls. 2. Highlight a call record. 3. Press Details. Doing so displays information such as called number, calling number, time of day, and call duration (for placed and received calls only).
Erase all call records in all logs	Press  , choose Directories , then press Clear .
Erase all call records in a single log	<ol style="list-style-type: none"> 1. Press , choose Directories > Missed Calls, Placed Calls, or Received Calls. 2. Highlight a call record. 3. Press Clear. (You may need to press the more softkey to display Clear.)
Erase a single call record	<ol style="list-style-type: none"> 1. Press , choose Directories > Missed Calls, Placed Calls, or Received Calls. 2. Highlight a call record. 3. Press Delete.

If you want to...	Then...
Dial from a call log (while not on another call)	<ol style="list-style-type: none"> 1. Press  and choose Directories > Missed Calls, Placed Calls, or Received Calls. 2. Highlight a call record from the log. <p>Note If the Details softkey appears, the call is the primary entry of a multiparty call. See the Tip section below.</p> <ol style="list-style-type: none"> 3. If you need to edit the displayed number, press EditDial followed by << or >>. To delete the number, press EditDial followed by Delete. (You may need to press the more softkey to display Delete.) 4. Go off-hook to place the call.
Dial from a call log (while connected to another call)	<ol style="list-style-type: none"> 1. Press , and choose Directories > Missed Calls, Placed Calls, or Received Calls. 2. Highlight a call record from the log. <p>Note If the Details softkey displays, the call is the primary entry of a multiparty call. See the Tip section below.</p> <ol style="list-style-type: none"> 3. If you need to edit the displayed number, press EditDial followed by << or >>. To delete the number, press EditDial followed by Delete. (You may need to press the more softkey to display Delete.) 4. Press Dial. 5. Choose one of the following to handle the original call: <ul style="list-style-type: none"> – Hold—Puts the first call on hold. – Transfer—Transfers the first party to the second and drops you from the call. (Press Transfer again after dialing to complete the action.) – Confrn—Creates a conference call with all parties, including you. (Press Confrn again after dialing to complete the action.) – EndCall—Disconnects the first call and dials the second.
Place a call from a URL entry in a call log (SIP phones only)	<ol style="list-style-type: none"> 1. Press , and choose Directories > Missed Calls, Placed Calls, or Received Calls. 2. Highlight the URL entry that you want to dial. 3. If you need to edit the entry, press EditDial. The  icon appears to indicate that you can begin editing characters in the URL entry. 4. Press Dial.

Tip
(SCCP phones only)

To view the complete call record of a multiparty call, press **Details**. The Details record shows two entries for each missed or received multiparty call. The entries are listed in reverse chronological order:

- The first logged entry is the name/number of the last completed call of a multiparty call received on your phone.
- The second logged entry is the name/number of the first completed call of a multiparty call received on your phone.

Directory Dialing

Depending on configuration, your phone can provide corporate and personal directory features:

- **Corporate Directory**—Corporate contacts that you can access on your phone. Your system administrator sets up and maintains your Corporate Directory.
- **Personal Directory**—If available, personal contacts and associated speed-dial codes that you can configure and access from your phone and User Options web pages. Personal Directory comprises the Personal Address Book (PAB) and Fast Dials.
 - PAB is a directory of your personal contacts.
 - Fast Dials allows you to assign codes to PAB entries for quick dialing.
 - For more information, see [Using the User Options Web Pages, page 50](#).

Using Corporate Directory on Your Phone

You can use a corporate directory to place calls to coworkers.

If you want to...	Then...
Dial from a corporate directory (while not on another call)	<ol style="list-style-type: none"> 1. Press , and choose Directories > Corporate Directory (exact name can vary). 2. User your keypad to enter a full or partial name and press Search. 3. To dial, select the listing, and go off-hook.

If you want to...	Then...
Dial from a corporate directory (while connected to another call)	<ol style="list-style-type: none"> 1. Press , and choose Directories > Corporate Directory (exact name can vary). 2. Use your keypad to enter a full or partial name, and press Search. 3. Scroll to a listing and press Dial. 4. Choose one of the following to handle the original call: <ul style="list-style-type: none"> – Hold—Puts the first call on hold. – Transfer—Transfers the first party to the second and drops you from the call. (Press Transfer again after dialing to complete the action.) – Confrn—Creates a conference call with all parties, including you. (Press Confrn again after dialing to complete the action.) – EndCall—Disconnects the first call and dials the second.

Tip



Use the numbers on your keypad to enter characters on your phone screen. Use the Navigation button on your phone to move between input fields.

Using Personal Directory on Your Phone

The Personal Directory feature set contains your Personal Address Book (PAB) and Fast Dial codes. This section describes how to set up and use Personal Directory on your phone. Alternately, see [Using Personal Directory on the Web, page 51](#).

If you want to...	Then...
Access Personal Directory (for PAB and Fast Dial codes)	<ol style="list-style-type: none"> 1. Press , and choose Directories > Personal Directory (exact name can vary). 2. Enter your Cisco Unified Communications Manager user ID and PIN, then press Submit.
Search for a PAB entry	<ol style="list-style-type: none"> 1. Access Personal Directory, then choose Personal Address Book. 2. Enter search criteria and press Submit. 3. You can choose Previous or Next to move through listings. 4. Highlight the PAB listing that you want and press Select.

If you want to...	Then...
Dial from PAB entry	<ol style="list-style-type: none"> 1. Search for a listing. 2. Highlight the listing and press Select. 3. Press Dial. (You may need to press the more softkey to see Dial.) 4. Enter the participant's phone number. 5. Highlight the number that you want to dial and press OK. 6. Press OK again to dial the number.
Delete a PAB entry	<ol style="list-style-type: none"> 1. Search for a listing. 2. Highlight the listing and press Delete. 3. Choose OK to confirm the deletion.
Edit a PAB entry	<ol style="list-style-type: none"> 1. Search for a listing. 2. Highlight the listing and press Edit to modify a name or email address. 3. If necessary, choose Phones to modify a phone number. 4. Press Update.
Add a new PAB entry	<ol style="list-style-type: none"> 1. Access Personal Directory, then choose Personal Address Book. 2. Access the Search page by choosing Submit. (You do not need to input search information first.) 3. Press New. 4. Use your phone keypad to enter a name and email information. 5. Choose Phones and use the keypad to enter phone numbers. Be sure to include any necessary access codes such as a 9 or 1. 6. Choose Submit to add the entry to the database.
Assign a Fast Dial code to a PAB entry	<ol style="list-style-type: none"> 1. Search for a PAB entry. 2. Highlight the listing and press Select. 3. Press Fast Dial. 4. Highlight the number that you want to dial and press Select. 5. Highlight the Fast Dial code that you want to assign to the number and press Select.

If you want to...	Then...
Add a raw Fast Dial code (not using a PAB entry)	<ol style="list-style-type: none"> 1. Press , and choose Directories > Personal Directory > Personal Fast Dials. 2. Press Fast Dial. 3. Highlight a Fast Dial code that is unassigned and press Select. 4. Press Assign. 5. Enter a phone number. 6. Press Update.
Search for Fast Dial codes	<ol style="list-style-type: none"> 1. Press , and choose Directories > Personal Directory > Personal Fast Dials. 2. You can choose Previous or Next to move through listings. 3. Highlight the listing that you want and press Select.
Place a call using a Fast Dial code	<ol style="list-style-type: none"> 1. Search for a Fast Dial code. 2. Highlight the listing you want and press Select. 3. Press Dial. 4. Choose OK to complete the action.
Delete a Fast Dial code	<ol style="list-style-type: none"> 1. Search for a Fast Dial code. 2. Highlight the listing you want and press Select. 3. Press Remove.
Log out of Personal Directory	<ol style="list-style-type: none"> 1. Press , and choose Directories > Personal Directory (exact name can vary). 2. Choose Logout.

Tips



- Your system administrator can provide you the user ID and PIN that you need to log in to Personal Directory.
- Personal Directory automatically logs you out after a certain amount of time. This time limit can vary. Ask your system administrator for more information.
- Use the numbers on your keypad to enter characters on your phone screen. Use the Navigation button on your phone to move between input fields.

Accessing Voice Messages

To access voice messages, press , and select **Messages**.



Note Your company determines the voice message service that your phone system uses. For the most accurate and detailed information, refer to the documentation that came with your voice message service.

If you want to...	Then...
Set up and personalize your voice message service	Do one of the following: <ul style="list-style-type: none"> • Press Msgs and follow the voice instructions. • Press , select Messages, and follow the voice instructions.
See if you have a new voice message	Look for: <ul style="list-style-type: none"> • A steady red light on your handset. (This indicator can vary. See Customizing Rings and Message Indicators, page 41.) • A flashing message waiting icon  on your phone screen. Listen for: <ul style="list-style-type: none"> • A stutter tone from your handset, headset, or speakerphone when you place a call.
Listen to your voice messages or access the voice messages menu	Do one of the following: <ul style="list-style-type: none"> • Press Msgs and follow the voice instructions. • Press , select Messages, and follow the voice instructions.
Send a call to a voice message system	Press Divert . For more information, see Sending a Call to a Voice Message System, page 21.

Using the User Options Web Pages

Your Cisco Unified IP Phone is a network device that can share information with other network devices in your company, including your personal computer. You can use your computer to log in to your Cisco Unified CM User Options web pages, where you can control features, settings, and services for your Cisco Unified IP Phone. For example, you can set up speed-dial numbers from your User Options web pages.

Accessing Your User Options Web Pages

This section describes how to log in and select a phone device.

If you want to...	Then do this...
Log in to your User Options web pages	<ol style="list-style-type: none"><li data-bbox="319 672 1166 732">1. Obtain a User Options URL, user ID, and default password from your system administrator.<li data-bbox="319 743 1130 773">2. Open a web browser on your computer, enter the URL, and log on.<li data-bbox="319 784 1159 813">3. If prompted to accept security settings, click Yes or Install Certificate. <p data-bbox="361 824 1204 914">The Cisco Unified Communications Manager User Options main web page displays. From this page you can select User Options to access User Settings, Directory features, a Personal Address Book, and Fast Dials.</p> <p data-bbox="361 925 1089 954">Or, to access phone-specific options, select a device (see below).</p>
Select a device after logging in	<ol style="list-style-type: none"><li data-bbox="319 974 1204 1034">1. After you have logged in to your User Options pages, choose User Options > Device. <p data-bbox="361 1045 825 1075">The Device Configuration page displays.</p> <ol style="list-style-type: none"><li data-bbox="319 1086 1204 1175">2. If you have multiple devices assigned to you, choose the appropriate device (phone model, Extension Mobility profile, or Remote Destination profile) from the Name drop-down menu. <p data-bbox="319 1187 1180 1247">Note Toolbar buttons located at the top of the Device Configuration page are specific to the selected device type.</p>
Select a configuration option after logging in	<ol style="list-style-type: none"><li data-bbox="319 1256 1180 1347">1. After you have logged in to your User Options web pages, choose User Options to access User Settings, Directory, Personal Address Book, Fast Dials, and Mobility Settings.<li data-bbox="319 1359 1170 1419">2. To return to the Device Configuration page from another page, choose User Options > Device.

Configuring Features and Services on the Web

The topics in this section describe how to configure features and services from your User Options web pages after logging in. See [Accessing Your User Options Web Pages, page 50](#).

Using Personal Directory on the Web

The Personal Directory feature set that you can access on your computer consists of:

- A Personal Address Book (PAB)
- Fast Dials
- Cisco Unified Communications Manager Address Book Synchronizer



Note You can also access PAB and Fast Dials from your phone. See [Using Personal Directory on Your Phone, page 46](#).

Using Your Personal Address Book on the Web

This section describes how to use your PAB from the User Options web pages.

If you want to...	Then do this after you log in...
Add a new PAB entry	<ol style="list-style-type: none"> 1. Choose User Options > Personal Address Book. 2. Choose Add New. 3. Enter information for the entry. 4. Click Save.
Search for a PAB entry	<ol style="list-style-type: none"> 1. Choose User Options > Personal Address Book. 2. Specify search information and click Find.
Edit a PAB entry	<ol style="list-style-type: none"> 1. Search for a PAB entry. 2. Click a name or nickname. 3. Edit the entry as needed and click Save.
Delete a PAB entry	<ol style="list-style-type: none"> 1. Search for a PAB entry. 2. Select one or more entries. 3. Click Delete Selected.

Configuring Fast Dials on the Web

This section describes how to assign Fast Dials from your User Options web pages.

If you want to...	Then do this after you log in...
Assign a line button for Fast Dial	<p>Note Before you can assign a line button for Fast Dial, your system administrator must configure the phone to display services. Contact your system administrator for more information.</p> <ol style="list-style-type: none">1. Choose User Options > Device.2. Click Service URL.3. Choose the Fast Dial service from the Button drop-down list box.4. Enter a phone label for the button.5. Click Save.6. Click Reset and then click Restart to refresh the phone configuration. <p>You can now press the line button to access Fast Dial codes.</p>
Assign a Fast Dial code to a PAB entry	<ol style="list-style-type: none">1. Create a PAB entry. See Using Your Personal Address Book on the Web, page 51.2. Choose User Options > Fast Dials.3. Click Add New.4. Use the Search Options area to find the appropriate PAB entry.5. Click a phone number in the Search Results area.6. Change the Fast Dial code, if desired.7. Click Save.
Assign a Fast Dial code to a phone number (without using a PAB entry)	<ol style="list-style-type: none">1. Choose User Options > Fast Dials.2. Click Add New.3. Change the Fast Dial code, if desired.4. Enter a phone number.5. Click Save.
Search for a Fast Dial entry	<ol style="list-style-type: none">1. Choose User Options > Fast Dials.2. Specify search information and click Find.
Edit a Fast Dial phone number	<ol style="list-style-type: none">1. Choose User Options > Fast Dials.2. Search for the Fast Dial entry that you want to edit.3. Click on a component of the entry.4. Change the phone number.5. Click Save.

If you want to...	Then do this after you log in...
Delete a Fast Dial entry	<ol style="list-style-type: none"> 1. Search for a Fast Dial. 2. Select one or more entries. 3. Click Delete Selected.
Assign a line button for PAB	<p>Note Before you can assign a line button for PAB, your system administrator must configure the phone to display services. Contact your system administrator for more information.</p> <ol style="list-style-type: none"> 1. Choose User Options > Device. 2. Click Service URL. 3. Choose the Personal Address Book service from the Button drop-down list box. 4. Enter a phone label for the button. 5. Click Save. 6. Click Reset and then click Restart to refresh the phone configuration. <p>You can now press the line button to access PAB codes.</p>

Tips

- You can create up to 500 Fast Dial and PAB entries.
- You can create a new Fast Dial entry without using a PAB entry. Such Fast Dial entries are labeled “raw” in the User Options pages and do not display a configurable text label.

Using the Address Book Synchronization Tool

You can use the Address Book Synchronization Tool (TABSynch) to synchronize your existing Microsoft Windows Address Book (if applicable) with your PAB. Entries from your Microsoft Windows Address Book will then be accessible on your Cisco Unified IP Phone and User Options web pages. Your system administrator can give you access to TABSynch and provide detailed instructions.

Setting Up Speed Dials on the Web

Depending on configuration, your phone can support several speed-dial features:

- Speed-dial numbers
- Abbreviated Dialing
- Fast Dials



Note For help using speed dial features, see [Speed Dialing, page 27](#).

If you want to...	Then do this after you log in...
Set up speed-dial numbers	<ol style="list-style-type: none"> 1. Choose User Options > Device. 2. Choose a phone from the Name drop-down menu. 3. Click Speed Dials. 4. Enter a number and label for a speed-dial number on your phone. 5. Click Save. <p>Note Your phone uses the ASCII Label field.</p>
Set up Abbreviated dialing	<ol style="list-style-type: none"> 1. Choose User Options > Device. 2. Choose a phone from the Name drop-down menu. 3. Click Speed Dials. 4. Enter a number and label for an Abbreviated Dialing code. 5. Click Save.
Set up Fast Dials	<p>See Configuring Fast Dials on the Web, page 52.</p> <p>You can also set up Fast Dials on your phone. See Using Personal Directory on Your Phone, page 46.</p>

Setting Up Phone Services on the Web

Phone services can include special phone features, network data, and web-based information (such as stock quotes and movie listings). You must first subscribe to a phone service before accessing it on your phone.

If you want to...	Then do this after you log in and select a device...
Subscribe to a service	<ol style="list-style-type: none"> 1. Choose User Options > Device. 2. Choose a phone from the Name drop-down menu. 3. Click Phone Services. 4. Click Add New. 5. Choose a service from the drop-down list and click Next. 6. Change the service label and/or enter additional service information, if available (optional). 7. Click Save.
Search for services	<ol style="list-style-type: none"> 1. Select a device. 2. Click Phone Services. 3. Click Find.
Change or end services	<ol style="list-style-type: none"> 1. Search for services. 2. Select one or more entries. 3. Click Delete Selected.
Change a service name	<ol style="list-style-type: none"> 1. Search for services. 2. Click on the service name. 3. Change the information and click Save.
Access a service on your phone	Choose Services  .

Controlling User Settings on the Web

User settings include your password, PIN, and language (locale) settings.

If you want to...	Then do this after you log in...
Change your password	<ol style="list-style-type: none">1. Choose User Options > User Settings.2. In the Browser Password area, enter information.3. Click Save.
Change your PIN	<ol style="list-style-type: none">1. Choose User Options > User Settings.2. In the Phone PIN area, enter information.3. Click Save.
Change the language (locale) for your User Options pages	<ol style="list-style-type: none">1. Choose User Options > User Settings.2. In the User Locale area, choose an item from the Locale drop-down list.3. Click Save.
Change the language (locale) for your phone screen	<ol style="list-style-type: none">1. Choose User Options > User Settings.2. Choose an item from the User Locale drop-down list.3. Click Save.

Tip

Your PIN and password allow you to access different features and services. For example, use your PIN to log in to Cisco Extension Mobility or Personal Directory on your phone. Use your password to log in to your User Options web pages and Cisco WebDialer on your personal computer. For more information, ask your system administrator.

Controlling Line Settings on the Web

Line settings affect a specific phone line (directory number) on your phone. Line settings can include call-forwarding, voice message indicators, ring patterns, and line labels.

You can set up other line settings directly on your phone:

- Set up call forwarding for your primary phone line—see [Forwarding Calls to Another Number, page 21](#).
- Change rings, display, and other phone-model specific settings—see [Changing Phone Settings, page 41](#).

If you want to...	Then do this after you log in...
Set up call forwarding per line	<ol style="list-style-type: none"> 1. Choose User Options > Device. 2. Choose a phone from the Name drop-down menu. 3. Click Line Settings. 4. In the Incoming Call Forwarding area, choose call forwarding settings for various conditions. 5. Click Save.
Change the voice message indicator setting per line	<ol style="list-style-type: none"> 1. Choose User Options > Device. 2. Choose a phone from the Name drop-down menu. 3. Click Line Settings. 4. In the Message Waiting Lamp area, choose from various settings. <p>Note Typically, the default message waiting setting prompts your phone to display a steady red light from the handset light strip to indicate a new voice message.</p> <ol style="list-style-type: none"> 5. Click Save.
Change the audible voice message indicator setting per line	<ol style="list-style-type: none"> 1. Choose User Options > Device. 2. Choose a phone from the Name drop-down menu. 3. Click Line Settings. 4. In the Audible Message Waiting Indicator area, choose from various settings. <p>Note Typically, the default message waiting setting prompts your phone to display a steady red light from the handset light strip to indicate a new voice message.</p> <ol style="list-style-type: none"> 5. Click Save.
Change or create a line text label that appears on your phone screen	<ol style="list-style-type: none"> 1. Choose User Options > Device. 2. Choose a phone from the Name drop-down menu. 3. Click Line Settings. 4. In the Line Text Label area, enter a text label. 5. Click Save. <p>Note Your phone uses the ASCII Label field if the phone does not support double-byte character sets.</p>

Setting Up Phones and Access Lists for Mobile Connect

When using Cisco Mobile Connect, you must add your cellular and other phones that you want to use to make and receive calls using the same directory numbers as your desk phone. These phones are called *remote destinations*. You can also define access lists to restrict or allow calls from certain numbers to be sent to your cellular phone.

If you want to...	Then do this after you log in...
Create an access list	<ol style="list-style-type: none">1. Choose User Options > Mobility Settings > Access Lists.2. Click Add New.3. Enter the following information:<ul style="list-style-type: none">- Name—Identifies the access list.- Description—Describes the access list.4. Choose one of these options:<ul style="list-style-type: none">- Blocked Access List—Creates list for numbers to be blocked- Allowed Access List—Creates list for numbers that will be permitted5. Click Save.
Add members to an access list.	<ol style="list-style-type: none">1. Create an access list.2. Click Add Member to add phone numbers or filters to the list.3. Select an option from the Filter Mask drop-down list box. You can filter a directory number, calls with restricted caller ID (Not Available), or calls with anonymous caller ID (Private).4. If you select a directory number from the Filter Mask drop-down list box, enter a phone number or filter in the DN Mask field. You can use the following wild cards to define a filter:<ul style="list-style-type: none">- X (upper or lower case)—Matches a single digit. For example, 408555123X matches any number between 4085551230 and 4085551239.- !—Matches any number of digits. For example, 408! matches any number starts with 408.- #—Used as a single digit for exact match.5. To add this member to the access list, click Save.6. To save the access list, click Save.

If you want to...	Then do this after you log in...
Add a new remote destination	<ol style="list-style-type: none"> 1. Choose User Options > Mobility Settings > Remote Destinations. 2. Select the device from the Name drop-down list box. 3. Click Remote Destinations. 4. Click Add New. 5. Enter the following information: <ul style="list-style-type: none"> - Name—Enter a name for the cellular (or other) phone. - Destination Number—Enter your cellular phone number. - Answer Too Soon Timer—Enter the amount of time before you can pick up a call on the remote destination (in milliseconds). - Answer Too Late Timer—Enter the amount of time after which it is too late to pick up a call on the remote destination (in milliseconds). - Delay Before Ringing Timer—Enter the amount of time before the call rings on the remote destination (in milliseconds). - Remote Destination Profile—Select a remote destination profile, which contains the settings that apply to all of your remote destinations. - Allowed Access List—Select a phone number or rule that allows your cellular phone to ring when a call comes in to your desktop phone. You can select an allowed access list or blocked access list, but not both. - Blocked Access List—Select a phone number or rule for which your cellular phone does not ring when a call comes in to your desktop phone. You can select an allowed access list or blocked access list, but not both. - Mobile Phone—Select to allow your cellular phone to accept a call sent from your desktop phone. - Enable Mobile Connect—Select to allow your cellular phone to ring simultaneously with your desktop phone. - Smart Client Installed—Select to indicate that the remote destination you are setting up is a smartphone. 6. Click Save.

Using Cisco WebDialer

Cisco WebDialer allows you to make calls on your Cisco Unified IP Phone to directory contacts by clicking on items in a web browser. Your system administrator must configure this feature for you.

If you want to...	Then...
Use WebDialer with your User Options directory	<ol style="list-style-type: none"> <li data-bbox="337 224 1216 289">1. Log in to your User Options web pages. See Accessing Your User Options Web Pages, page 50. <li data-bbox="337 293 1216 326">2. Choose User Options > Directory and search for a coworker. <li data-bbox="337 331 1216 363">3. Click the number that you want to dial. <li data-bbox="337 368 1216 433">4. If this is your first time using WebDialer, set up preferences on the Make Call page. <li data-bbox="337 438 1216 503">5. Click Dial. (See the last row in this table to learn how to suppress this page in the future, if desired.) The call is now placed on your phone. <li data-bbox="337 508 1216 597">6. To end a call, click Hangup or hang up from your phone.
Use WebDialer with another online corporate directory (not your User Options directory)	<ol style="list-style-type: none"> <li data-bbox="337 602 1216 667">1. Log in to a WebDialer-enabled corporate directory and search for coworkers. <li data-bbox="337 672 1216 704">2. Click the number that you want to dial. <li data-bbox="337 709 1216 742">3. When prompted, enter your user ID and password. <li data-bbox="337 747 1216 812">4. If this is your first time using WebDialer, set up preferences on the Make Call page. <li data-bbox="337 816 1216 881">5. Click Dial. (See the last row in this table to learn how to suppress this page in the future, if desired.) The call is now placed on your phone. <li data-bbox="337 886 1216 979">6. To end a call, click Hangup or hang up from your phone.

If you want to...	Then...
Log out of WebDialer	Click the logout icon in the Make Call or Hang Up page.
Set up, view, or change WebDialer preferences	<p data-bbox="388 235 700 261">Access the Make Call page.</p> <p data-bbox="388 277 1251 332">The Make Call page appears the first time that you use WebDialer (after you click the number that you want to dial.)</p> <p data-bbox="388 349 982 375">The Make Call page contains the following options:</p> <ul data-bbox="401 391 1251 699" style="list-style-type: none"> <li data-bbox="401 391 1184 446">• Preferred language—Determines the language used for WebDialer settings and prompts. <li data-bbox="401 462 1251 699">• Use preferred device—Identifies the Cisco Unified IP Phone (Calling device) and directory number (Calling line) that you will use to place WebDialer calls. If you have one phone with a single line, the appropriate phone and line are automatically selected. Otherwise, choose a phone and/or line. If you have more than one phone, it will be specified by device type and MAC address. (To display the MAC address on your phone, press  and choose Settings > Network Configuration > Host Name.) <p data-bbox="388 716 1251 771">Note If you have an Extension Mobility profile, you can select your Extension Mobility logged-in device from the Calling device menu.</p> <ul data-bbox="401 797 1251 878" style="list-style-type: none"> <li data-bbox="401 797 1251 878">• Do not display call confirmation—If selected, prompts WebDialer to suppress the Make Call page. This page appears by default after you click a phone number in a WebDialer-enabled online directory.

Understanding Additional Configuration Options

Your system administrator can configure your phone to use specific button and softkey templates along with special services and features, if appropriate. This table provides an overview of some configuration options that you might want to discuss with your phone system administrator based on your calling needs or work environment.



Note You can locate Phone Guides and other documents listed in this table on the web: http://www.cisco.com/en/US/products/hw/phones/ps379/tsd_products_support_series_home.html

If you...	Then...	For more information...
Need to handle more calls on your phone line	Ask your system administrator to configure your line to support more calls.	Talk to your system administrator or phone support team.
Work with (or work as) an administrative assistant	Consider using a shared line.	See Using a Shared Line, page 30 .
Want to use one extension for several phones	Request a shared line. This allows you to use one extension for your desk phone and lab phone, for example.	See Using a Shared Line, page 30 .
Share phones or office space with coworkers	Consider using: <ul style="list-style-type: none"> • Call Park to store and retrieve calls without using the transfer feature. • Call Pickup to answer calls ringing on another phone. • A shared line to view or join co-workers' calls. • Cisco Extension Mobility to apply your phone number and user profile to a shared Cisco Unified IP Phone. 	Ask your system administrator about these features and see: <ul style="list-style-type: none"> • Advanced Call Handling, page 27. • Using a Shared Line, page 30. • Using Cisco Extension Mobility, page 35.
Want to temporarily apply your phone number and settings to a shared Cisco Unified IP Phone	Ask your system administrator about the Cisco Extension Mobility service.	See Using Cisco Extension Mobility, page 35 .

Troubleshooting Your Phone

This section provides troubleshooting information for your Cisco Unified IP Phone.





General Troubleshooting

This section provides information to help you troubleshoot general problems with your phone. For more information, see your system administrator.

Symptom	Explanation
You cannot hear a dial tone or complete a call	<p>One or more of the following factors might apply:</p> <ul style="list-style-type: none"> You must log into the Extension Mobility service. You must enter a client matter code (CMC) or forced authorization code (FAC) after dialing a number. (SCCP phones only.) Your phone has time-of-day restrictions that prevent you from using some features during certain hours of the day.
The softkey that you want to use does not appear	<p>One or more of the following factors might apply:</p> <ul style="list-style-type: none"> You must press more to reveal additional softkeys. You must change the line state (for example, go off-hook or have a connected call). Your phone is not configured to support the feature associated with that softkey.
Barge fails and results in a fast busy tone	You cannot barge an encrypted call if the phone you are using is not configured for encryption. When your barge attempt fails for this reason, your phone plays a fast busy tone.
You are disconnected from a call that you joined using Barge	You will be disconnected from a call that you have joined using Barge if the call is put on hold, transferred, or turned into a conference call.
Cisco CallBack fails	The other party might have call forwarding enabled.

Viewing Phone Administration Data

Your system administrator might ask you to access administration data on your phone for troubleshooting purposes.

If you are asked to...	Then...
Access network configuration data	Press  and choose Settings > Network Configuration and select the network configuration item that you want to view.
Access status data	Press  and choose Settings > Status and select the status item that you want to view.
Access phone model information	Press  and choose Settings > Model Information .
Access phone call and voice quality information	Press  and choose Settings > Status > Call Statistics .

Using the Quality Reporting Tool

Your system administrator may temporarily configure your phone with the Quality Reporting Tool (QRT) to troubleshoot performance problems. You can press **QRT** to submit information to your system administrator. Depending on configuration, use the QRT to:

- Immediately report an audio problem on a current call
- Select a general problem from a list of categories and choose reason codes

Cisco One-Year Limited Hardware Warranty Terms

There are special terms applicable to your hardware warranty and various services that you can use during the warranty period. Your formal Warranty Statement, including the warranties and license agreements applicable to Cisco software, is available on Cisco.com at the following URL:

http://www.cisco.com/en/US/docs/general/warranty/English/1Y1DEN__.html

Index

A

- Abbreviated Dialing [15, 27](#)
- Address Book Synchronization Tool [53](#)
- answering calls [17](#)
- Applications Menu button [10](#)
- Applications menus, using [12](#)
- ASCII label field support [54](#)
- authenticated calls [32](#)
- Auto Dial [14](#)
- AutoAnswer [17](#)

B

- barge
 - and privacy [32](#)
 - and shared lines [30](#)
 - using [31](#)
- buttons, identifying [9](#)

C

- call forwarding [21](#)
 - configuring on phone [22](#)
- call logs
 - dialing from [14](#)
 - erasing [43](#)
 - viewing and dialing from [43](#)

- call park [17, 29](#)
- call pickup [17, 28](#)
- call waiting [17](#)
- CallBack [15](#)
- caller ID [10](#)
- call-handling
 - advanced [27](#)
 - basic [14](#)
- calls
 - answering [17](#)
 - barging [31](#)
 - compared to lines [11](#)
 - conference features for [23](#)
 - ending [18](#)
 - forwarding [21](#)
 - handling multiple [17](#)
 - holding and resuming [18](#)
 - icons for [11](#)
 - maximum per line [11](#)
 - monitoring [38](#)
 - multiple parties on [23](#)
 - multiple, switching between [19](#)
 - parking [29](#)
 - placing [14, 15](#)
 - prevent barging of [32](#)
 - prioritizing [33](#)
 - redirecting while ringing [17, 28](#)

- reporting problems with [64](#)
- secure [32](#)
- storing and retrieving [29](#)
- transferring [20](#)
- viewing [10, 20](#)
- Cisco Extension Mobility feature, using [16](#)
- Cisco Unified IP Phone
 - connecting [5](#)
 - documentation for [1](#)
 - feature configuration for [12](#)
 - illustration [9](#)
 - protocol [13](#)
 - registering [7](#)
 - SCCP [13](#)
 - securing handset rest [7](#)
 - SIP [13](#)
 - troubleshooting [63](#)
 - web-based services for [55](#)
- Cisco WebDialer [59](#)
- Client Matter Code
 - See CMC
- CMC [63](#)
- conference
 - levels of security [32](#)
 - secure [32](#)
- conference calls
 - Meet-Me [25](#)
 - removing participants from [26](#)
 - security-level for [26](#)
 - types of [23](#)
 - viewing participants for [26](#)
- corporate directory
 - dialing from [15](#)

- dialing from web page [15](#)
- using on phone [45](#)

D

- Details softkey, viewing multiparty calls with [44](#)
- device configuration page [50](#)
- dialing options
 - additional [15](#)
 - basic [14](#)
- dialing, options for [14, 15](#)
- directory
 - corporate [45](#)
 - dialing from [15](#)
 - personal [46](#)
 - using from web page [59](#)
 - using on phone [43](#)
- DND [22](#)
- Do Not Disturb (DND) [22](#)
- documentation, accessing [1](#)

E

- encrypted calls [32](#)
- ending a call, options [18](#)
- Extension Mobility
 - EM [35](#)
- external devices, using [2](#)

F

- FAC [63](#)
- Fast Dials

- configuring from web page [47](#)
- using on phone [46](#)

features, availability of [12](#)

Forced Authorization Code

- See FAC

forwarding calls, options for [21](#)

G

group call pickup [28](#)

Group Listen [38](#)

H

handset

- light strip [10](#)
- securing in cradle [7](#)
- using [38, 39](#)

hands-free listening [38](#)

hanging up, options for [18](#)

headset

- connecting [7](#)
- performance [8](#)

help, using [12](#)

hold

- and switching calls [19](#)
- and transferring [20](#)
- using [18](#)

hold button illustration [10](#)

hold reversion [18](#)

hold reversion indicators [18](#)

hunt groups

- description [29](#)

- log out of [30](#)

I

icons, for call states [11](#)

installing, Cisco Unified IP Phone [5](#)

K

keypad description [10](#)

L

language (locale) settings [56](#)

lines

- compared to calls [11](#)
- description [11](#)
- description of [11](#)
- number of calls supported on [11, 62](#)
- shared [30](#)

logging out of hunt groups [30](#)

M

Malicious Call Identification

- See MCID

MCID [33](#)

Meet-Me conferences [25](#)

menus, using [12](#)

messages

- indicator for [41](#)
- listening to [49](#)

missed calls, records of [43](#)

MLPP, using [33](#)
monitoring a call [38](#)
multiparty calls
 identifying in call logs [44](#)
 viewing details of [44](#)
multiple calls, handling [17, 19](#)

N

navigation button illustration [10](#)

O

off-hook dialing [14](#)
on-hook dialing [14](#)

P

PAB
 dialing from [15](#)
 using from web page [51](#)
 using on phone [46](#)
parking a call [17](#)
password, changing [56](#)
Personal Address Book
 See PAB
Personal Directory
 using from web page [51](#)
 using on phone [46](#)
phone lines, description of [11](#)
phone services
 configuring [51](#)
 See also User Options web pages

PIN, changing [56](#)
placed calls, records of [43](#)
placing a call [14](#)
placing calls, options for [14, 15](#)
pre-dial [14](#)
prioritizing calls [33](#)
privacy
 and shared lines [30](#)
 using [32](#)

Q

QRT [64](#)
Quality Reporting Tool [64](#)

R

received calls, records of [43](#)
redial [14](#)
remote-in-use icon for shared lines [30](#)
resuming held calls [18](#)
reverting calls [18](#)
ring tones, changing [41](#)
ringer
 customizing [41](#)
 indicator for [10](#)
 volume for [41](#)

S

safety warnings [2](#)
SCCP (Skinny Call Control Protocol) [13](#)
secure calls [32](#)

- secure conferences [26](#)
- security, for calls [32](#)
- services, subscribing to [55](#)
- settings, customizing [41](#)
- shared lines
 - and remote-in-use icon [30](#)
 - description of [30](#)
 - with barge [31](#)
 - with privacy [32](#)
- signaling protocol [13](#)
- SIP (Session Initiation Protocol) [13](#)
- softkey buttons, description of [10](#)
- sound quality [8](#)
- speaker
 - answering calls with [17](#)
 - using [18](#)
- speaker, using [38](#)
- speed dial
 - configuring [27](#)
 - description of [27](#)
 - labels [54](#)
 - using [15](#)
- subscriptions, for phone services [55](#)
- suspicious calls, tracing [33](#)
- switching calls [19](#)

T

- TABSynch [53](#)
- TAPS [7](#)
- Tool for Auto-Registered Phones Support [7](#)
- transferring, options for [20](#)
- troubleshooting

- general [63](#)
- QRT [64](#)

U

- User Options web pages
 - accessing [50](#)
 - configuring features and services with [51](#)
 - subscribing to phone services with [55](#)
- using a headset [7](#)

V

- voice message indicator
 - description of [49](#)
- voice messages, accessing [49](#)
- volume
 - for handset, headset, or speaker [38, 39](#)
 - for phone ringer [41](#)
- volume button illustration [10](#)

W

- warnings, safety [2](#)
- web-based services
 - configuring [51](#)
 - See also User Options web pages
- WebDialer [59](#)



Americas Headquarters
Cisco Systems, Inc.
170 West Tasman Drive
San Jose, CA 95134-1706
USA
www.cisco.com
Tel: 408 526-4000
800 553-NETS (6387)
Fax: 408 527-0883

Asia Pacific Headquarters
Cisco Systems, Inc.
168 Robinson Road
#28-01 Capital Tower
Singapore 068912
www.cisco.com
Tel: +65 6317 7777
Fax: +65 6317 7799

Europe Headquarters
Cisco Systems International
BV
Haarlerbergpark
Haarlerbergweg 13-19
1101 CH Amsterdam
The Netherlands
www-europe.cisco.com
Tel: 31 0 800 020 0791
Fax: 31 0 20 357 1100

**Cisco has more than 200 offices worldwide. Addresses, phone numbers, and fax numbers are listed on the
Cisco Website at www.cisco.com/go/offices.**

CCDE, CCENT, Cisco Eos, Cisco Lumin, Cisco Nexus, Cisco StadiumVision, Cisco TelePresence, Cisco WebEx, the Cisco logo, DCE, and Welcome to the Human Network are trademarks; Changing the Way We Work, Live, Play, and Learn and Cisco Store are service marks; and Access Registrar, Aironet, AsyncOS, Bringing the Meeting To You, Catalyst, CCDA, CCDP, CCIE, CCIP, CCNA, CCNP, CCSP, CCVP, Cisco, the Cisco Certified Internetwork Expert logo, Cisco IOS, Cisco Press, Cisco Systems, Cisco Systems Capital, the Cisco Systems logo, Cisco Unity, Collaboration Without Limitation, EtherFast, EtherSwitch, Event Center, Fast Step, Follow Me Browsing, FormShare, GigaDrive, HomeLink, Internet Quotient, IOS, iPhone, iQuick Study, IronPort, the IronPort logo, LightStream, Linksys, MediaTone, MeetingPlace, MeetingPlace Chime Sound, MGX, Networkers, Networking Academy, Network Registrar, PCNow, PIX, PowerPanels, ProConnect, ScriptShare, SenderBase, SMARTnet, Spectrum Expert, StackWise, The Fastest Way to Increase Your Internet Quotient, TransPath, WebEx, and the WebEx logo are registered trademarks of Cisco Systems, Inc. and/or its affiliates in the United States and certain other countries.



All other trademarks mentioned in this document or website are the property of their respective owners. The use of the word partner does not imply a partnership relationship between Cisco and any other company. (0809R)
The Java logo is a trademark or registered trademark of Sun Microsystems, Inc. in the U.S. or other countries.

© 2008 Cisco Systems, Inc. All rights reserved.