



Cisco Unified IP Phone 7905G and 7912G for Cisco Unified CallManager 5.0 (SCCP)





INCLUDING LICENSE AND WARRANTY

Corporate Headquarters

Cisco Systems, Inc.
170 West Tasman Drive
San Jose, CA 95134-1706
USA
<http://www.cisco.com>
Tel: 408 526-4000
800 553-NETS (6387)
Fax: 408 526-4100



Common Phone Tasks

Place a call	Go off-hook before or after dialing a number.
Redial a number	Press Redial .
Place a call on hold	Highlight a call and press  .
Resume a held call	Highlight a held call and press  .
Speed dial a number	<ul style="list-style-type: none"> Press  and select a number to dial. Press  and choose Directories > Speed Dials. Select a number to dial. Enter a speed dial number while on-hook and press AbbrDial.
Transfer a call to a new number	Press Trnsfer , enter the number, then hang up (or press Trnsfer again if your phone does not support on-hook transfer).
Start a standard conference call	Press more > Confrn and dial the participant. Then press Confrn again.



Cisco, Cisco IOS, Cisco Systems, and the Cisco Systems logo are registered trademarks of Cisco Systems, Inc. or its affiliates in the United States and certain other countries. All other brands, names, or trademarks mentioned in this document or Website are the property of their respective owners. The use of the word partner does not imply a partnership relationship between Cisco and any other company. (0501R)

© 2006 Cisco Systems, Inc. All rights reserved.

OL-8166-01



Cisco Unified IP Phone 7905G and 7912G for Cisco Unified CallManager 5.0 (SCCP)













Softkey Definitions
Phone Screen Icons
Button Icons
Common Phone Tasks



Softkey Definitions

AbbrDial	Dial using a speed dial index number
Answer	Answer a call
CallBack	Receive notification when a busy extension becomes available
Cancel	Cancel an action or exit a screen without applying changes
cBarge	Add yourself to a call on a shared line and establish a conference call
CFwdAll	Setup/cancel call forwarding
Clear	Delete records or settings
Close	Close the current window
ConFLis	View conference participants
Confrn	Create a conference call
Delete	Remove characters to the right of the cursor when using EditDial
Dial	Dial a phone number
DirTrfr	Transfer two calls to each other
EditDial	Edit a number in a call log
EndCall	Disconnect the current call
Exit	Return to the previous screen
Factory	Reset settings to the factory defaults
GPickUp	Answer a call ringing in another group
iDivert	Send a call to your voice messaging system
Join	Join several calls on a single line to create a conference call
MeetMe	Host a Meet-Me conference call





Monitor	Listen to a call on the speaker
MonOff	Disable the Monitor function
more	Display additional softkeys
Message	Access voice mail system
NewCall	Make a new call
OPickUp	Answer a call ringing in an associated group
Park	Store a call using Call Park
PickUp	Answer a call in your group
Private	Prevent others from viewing or barging calls on a shared line
QRT	Submit call problems to the system administrator
Redial	Redial the most recently dialed number
Remove	Remove a conference participant
Restore	Reset settings to their defaults
RmLstC	Drop the last party added to conference call
Save	Save the chosen settings
Select	Select a menu item or call
Submit	Search for a directory listing
Trnsfer	Transfer a call
Update	Refresh content
<<	Delete characters to the left of the cursor
>>	Move right through characters

Phone Screen Icons

Call State	
	Call Forwarding enabled
	Call on hold
	Connected call
	Off-hook
	Incoming call
	Ring out
	Shared line in use
Selected Device	
	Handset in use
	Speaker in use (Monitor on)
Critical Calls	
	Priority call
	Medium priority call
	High priority call
	Highest priority call

Other Features	
	Messages waiting
	Option selected

Button Icons

	Volume
	Navigation
	Hold
	Menu



Contents

Getting Started 1

Using this Guide 1

Finding Additional Information 2

Accessing Cisco Unified IP Phone 7900 Series eLearning Tutorials 2

Safety and Performance Information 2

Accessibility Features 12

Connecting Your Phone 13

An Overview of Your Phone 16

Understanding Buttons and Hardware 16

Understanding Feature Operation and Availability 17

Call-Handling and Navigation Tips 18

 Understanding Lines vs. Calls 18

 Going On-Hook and Off-Hook 18

 Choosing and Selecting Calls 19

 Switching Among Calls 19

Using Feature Menus 20

Entering and Editing Text 20

Basic Call Handling 21

Placing a Call 21

Answering a Call 23

Ending a Call 24

Using the Speaker 24

Using the Hold Button 25

Transferring a Connected Call 25

Making Conference Calls 26

Starting or Joining a Standard Conference Call	27
Starting or Joining a Meet-Me Conference Call	28
Forwarding Your Calls to Another Number	28
Advanced Call Handling	30
Speed Dialing	30
Storing and Retrieving Parked Calls	31
Picking Up a Redirected Call on Your Phone	32
Understanding Shared Lines	33
Remote-In-Use	33
Maximum Supported Calls on a Shared Line	33
Adding Yourself to a Shared-Line Call	34
Preventing Others from Viewing or Joining a Shared-Line Call	34
Tracing Suspicious Calls	35
Prioritizing Critical Calls	35
Using Cisco Extension Mobility	37
Using Phone Settings	38
Adjusting the Volume	38
Customizing Rings	39
Using Voice Messaging, Call Logs, and Directories	40
Accessing Voice Messages	40
Using Call Logs	41
Directory Dialing	41
Using Corporate Directory on Your Phone	42
Using Personal Directory on Your Phone	42
Customizing Your Phone on the Web	45
Accessing Your User Options Web Pages	45
Configuring Features and Services on the Web	46
Using Personal Directory on the Web	46
Using Your Personal Address Book on the Web	46
Configuring Fast Dials on the Web	47

Using the Address Book Synchronization Tool	48
Setting Up Speed Dials on the Web	48
Setting Up Phone Services on the Web	49
Controlling User Settings on the Web	50
Using Cisco WebDialer	51

Understanding Additional Configuration Options 53

Troubleshooting Your Phone 54

Using the Quality Reporting Tool	54
----------------------------------	----

Cisco One-Year Limited Hardware Warranty Terms 55



Getting Started

Using this Guide

This guide provides you with an overview of the features available on your phone. You can read it completely for a solid understanding of your phone's capabilities, or refer to the table below for pointers to commonly-used sections.

If you want to...	Then
Review important safety information	See the “Safety and Performance Information” section on page 2.
Use your phone after someone else has installed it for you	Start with the “An Overview of Your Phone” section on page 16.
Connect your phone to the network	See the “Connecting Your Phone” section on page 13.
Learn about the buttons and softkeys	See the “Understanding Buttons and Hardware” section on page 16.
Make calls	See the “Placing a Call” section on page 21.
Put calls on hold	See the “Using the Hold Button” section on page 25.
Transfer calls	See the “Transferring a Connected Call” section on page 25.
Make conference calls	See the “Making Conference Calls” section on page 26.
Answer calls ringing on another phone	See the “Picking Up a Redirected Call on Your Phone” section on page 32.
Change the ringer or call volume	See the “Adjusting the Volume” section on page 38.
Choose a different ring sound	See the “Customizing Rings” section on page 39.

Finding Additional Information

You can access the most current Cisco documentation on the World Wide Web at this URL:

<http://www.cisco.com/univercd/home/home.htm>

You can access the Cisco website at this URL:

<http://www.cisco.com/>

International Cisco websites can be accessed from this URL:

http://www.cisco.com/public/countries_languages.shtml

Accessing Cisco Unified IP Phone 7900 Series eLearning Tutorials

Cisco Unified IP Phone 7900 Series eLearning tutorials use audio and animation to demonstrate basic calling features. You can access eLearning tutorials online (for several phone models) from your personal computer. Look for the eLearning tutorial (English only) for your phone model in the documentation list at the following location:

http://cisco.com/en/US/products/hw/phones/ps379/products_user_guide_list.html

Safety and Performance Information

Read the following safety notices before installing or using your Cisco Unified IP Phone:

Warning IMPORTANT SAFETY INSTRUCTIONS

This warning symbol means danger. You are in a situation that could cause bodily injury. Before you work on any equipment, be aware of the hazards involved with electrical circuitry and be familiar with standard practices for preventing accidents. Use the statement number provided at the end of each warning to locate its translation in the translated safety warnings that accompanied this device. Statement 1071

SAVE THESE INSTRUCTIONS**Waarschuwing BELANGRIJKE VEILIGHEIDSINSTRUCTIES**

Dit waarschuwingssymbool betekent gevaar. U verkeert in een situatie die lichamelijk letsel kan veroorzaken. Voordat u aan enige apparatuur gaat werken, dient u zich bewust te zijn van de bij elektrische schakelingen betrokken risico's en dient u op de hoogte te zijn van de standaard praktijken om ongelukken te voorkomen. Gebruik het nummer van de verklaring onderaan de waarschuwing als u een vertaling van de waarschuwing die bij het apparaat wordt geleverd, wilt raadplegen.

BEWAAR DEZE INSTRUCTIES**Varoitus TÄRKEITÄ TURVALLISUUSOHJEITA**

Tämä varoitusmerkki merkitsee vaaraa. Tilanne voi aiheuttaa ruumiillisia vammoja. Ennen kuin käsittelet laitteistoa, huomioi sähköpiirien käsittelemiseen liittyvät riskit ja tutustu onnettomuuksien yleisiin ehkäisytapoihin. Turvallisuusvaroitusten käännökset löytyvät laitteen mukana toimitettujen käännettyjen turvallisuusvaroitusten joukosta varoitusten lopussa näkyvien lausuntonumeroiden avulla.

SÄILYTÄ NÄMÄ OHJEET

Attention IMPORTANTES INFORMATIONS DE SÉCURITÉ

Ce symbole d'avertissement indique un danger. Vous vous trouvez dans une situation pouvant entraîner des blessures ou des dommages corporels. Avant de travailler sur un équipement, soyez conscient des dangers liés aux circuits électriques et familiarisez-vous avec les procédures couramment utilisées pour éviter les accidents. Pour prendre connaissance des traductions des avertissements figurant dans les consignes de sécurité traduites qui accompagnent cet appareil, référez-vous au numéro de l'instruction situé à la fin de chaque avertissement.

CONSERVEZ CES INFORMATIONS

Warnung WICHTIGE SICHERHEITSHINWEISE

Dieses Warnsymbol bedeutet Gefahr. Sie befinden sich in einer Situation, die zu Verletzungen führen kann. Machen Sie sich vor der Arbeit mit Geräten mit den Gefahren elektrischer Schaltungen und den üblichen Verfahren zur Vorbeugung vor Unfällen vertraut. Suchen Sie mit der am Ende jeder Warnung angegebenen Anweisungsnummer nach der jeweiligen Übersetzung in den übersetzten Sicherheitshinweisen, die zusammen mit diesem Gerät ausgeliefert wurden.

BEWAHREN SIE DIESE HINWEISE GUT AUF.

Avvertenza IMPORTANTI ISTRUZIONI SULLA SICUREZZA

Questo simbolo di avvertenza indica un pericolo. La situazione potrebbe causare infortuni alle persone. Prima di intervenire su qualsiasi apparecchiatura, occorre essere al corrente dei pericoli relativi ai circuiti elettrici e conoscere le procedure standard per la prevenzione di incidenti. Utilizzare il numero di istruzione presente alla fine di ciascuna avvertenza per individuare le traduzioni delle avvertenze riportate in questo documento.

CONSERVARE QUESTE ISTRUZIONI

Advarsel VIKTIGE SIKKERHETSINSTRUKSJONER

Dette advarselssymbolet betyr fare. Du er i en situasjon som kan føre til skade på person. Før du begynner å arbeide med noe av utstyret, må du være oppmerksom på farene forbundet med elektriske kretser, og kjenne til standardprosedyrer for å forhindre ulykker. Bruk nummeret i slutten av hver advarsel for å finne oversettelsen i de oversatte sikkerhetsadvarslene som fulgte med denne enheten.

TA VARE PÅ DISSE INSTRUKSJONENE**Aviso INSTRUÇÕES IMPORTANTES DE SEGURANÇA**

Este símbolo de aviso significa perigo. Você está em uma situação que poderá ser causadora de lesões corporais. Antes de iniciar a utilização de qualquer equipamento, tenha conhecimento dos perigos envolvidos no manuseio de circuitos elétricos e familiarize-se com as práticas habituais de prevenção de acidentes. Utilize o número da instrução fornecido ao final de cada aviso para localizar sua tradução nos avisos de segurança traduzidos que acompanham este dispositivo.

GUARDE ESTAS INSTRUÇÕES**¡Advertencia! INSTRUCCIONES IMPORTANTES DE SEGURIDAD**

Este símbolo de aviso indica peligro. Existe riesgo para su integridad física. Antes de manipular cualquier equipo, considere los riesgos de la corriente eléctrica y familiarícese con los procedimientos estándar de prevención de accidentes. Al final de cada advertencia encontrará el número que le ayudará a encontrar el texto traducido en el apartado de traducciones que acompaña a este dispositivo.

GUARDE ESTAS INSTRUCCIONES**Varning! VIKTIGA SÄKERHETSANVISNINGAR**

Denna varningssignal signalerar fara. Du befinner dig i en situation som kan leda till personskada. Innan du utför arbete på någon utrustning måste du vara medveten om farorna med elkretsar och känna till vanliga förfaranden för att förebygga olyckor. Använd det nummer som finns i slutet av varje varning för att hitta dess översättning i de översatta säkerhetsvarningar som medföljer denna anordning.

SPARA DESSA ANVISNINGAR

Figyelem

FONTOS BIZTONSÁGI ELOÍRÁSOK

Ez a figyelmeztető jel veszélyre utal. Sérülésveszélyt rejtő helyzetben van. Mielőtt bármely berendezésen munkát végezte, legyen figyelemmel az elektromos áramkörök okozta kockázatokra, és ismerkedjen meg a szokásos balesetvédelmi eljárásokkal. A kiadványban szereplő figyelmeztetések fordítása a készülékhez mellékelt biztonsági figyelmeztetések között található; a fordítás az egyes figyelmeztetések végén látható szám alapján kereshető meg.

ORIZZE MEG EZEKET AZ UTASÍTÁSOKAT!

Предупреждение

ВАЖНЫЕ ИНСТРУКЦИИ ПО СОБЛЮДЕНИЮ ТЕХНИКИ БЕЗОПАСНОСТИ

Этот символ предупреждения обозначает опасность. То есть имеет место ситуация, в которой следует опасаться телесных повреждений. Перед эксплуатацией оборудования выясните, каким опасностям может подвергаться пользователь при использовании электрических цепей, и ознакомьтесь с правилами техники безопасности для предотвращения возможных несчастных случаев. Воспользуйтесь номером заявления, приведенным в конце каждого предупреждения, чтобы найти его переведенный вариант в переводе предупреждений по безопасности, прилагаемом к данному устройству.

СОХРАНИТЕ ЭТИ ИНСТРУКЦИИ

警告

重要的安全性说明

此警告符号代表危险。您正处于可能受到严重伤害的工作环境中。在您使用设备开始工作之前，必须充分意识到触电的危险，并熟练掌握防止事故发生的标准工作程序。请根据每项警告结尾提供的声明号码来找到此设备的安全性警告说明的翻译文本。

请保存这些安全性说明

警告 安全上の重要な注意事項

「危険」の意味です。人身事故を予防するための注意事項が記述されています。装置の取り扱い作業を行うときは、電気回路の危険性に注意し、一般的な事故防止策に留意してください。警告の各国語版は、各注意事項の番号を基に、装置に付属の「Translated Safety Warnings」を参照してください。

これらの注意事項を保管しておいてください。

주의 중요 안전 지침

이 경고 기호는 위험을 나타냅니다. 작업자가 신체 부상을 일으킬 수 있는 위험한 환경에 있습니다. 장비에 작업을 수행하기 전에 전기 회로와 관련된 위험을 숙지하고 표준 작업 관례를 숙지하여 사고를 방지하십시오. 각 경고의 마지막 부분에 있는 경고문 번호를 참조하여 이 장치와 함께 제공되는 번역된 안전 경고문에서 해당 번역문을 찾으십시오.

이 지시 사항을 보관하십시오.

Aviso INSTRUÇÕES IMPORTANTES DE SEGURANÇA

Este símbolo de aviso significa perigo. Você se encontra em uma situação em que há risco de lesões corporais. Antes de trabalhar com qualquer equipamento, esteja ciente dos riscos que envolvem os circuitos elétricos e familiarize-se com as práticas padrão de prevenção de acidentes. Use o número da declaração fornecido ao final de cada aviso para localizar sua tradução nos avisos de segurança traduzidos que acompanham o dispositivo.

GUARDE ESTAS INSTRUÇÕES**Advarsel** VIGTIGE SIKKERHEDSANVISNINGER

Dette advarselssymbol betyder fare. Du befinder dig i en situation med risiko for legemeskadedigelse. Før du begynder arbejde på udstyr, skal du være opmærksom på de involverede risici, der er ved elektriske kredsløb, og du skal sætte dig ind i standardprocedurer til undgåelse af ulykker. Brug erklæringsnummeret efter hver advarsel for at finde oversættelsen i de oversatte advarsler, der fulgte med denne enhed.

GEM DISSE ANVISNINGER

تحذير

إرشادات الأمان الهامة

يوضح رمز التحذير هذا وجود خطر. وهذا يعني أنك متواجد في مكان قد ينتج عنه التعرض لإصابات. قبل بدء العمل، احذر مخاطر التعرض للصدمات الكهربائية وكن على علم بالإجراءات القياسية للحيلولة دون وقوع أي حوادث. استخدم رقم البيان الموجود في آخر كل تحذير لتحديد مكان ترجمته داخل تحذيرات الأمان المترجمة التي تأتي مع الجهاز. قم بحفظ هذه الإرشادات

Upozorenje

VAŽNE SIGURNOSNE NAPOMENE

Ovaj simbol upozorenja predstavlja opasnost. Nalazite se u situaciji koja može prouzročiti tjelesne ozljede. Prije rada s bilo kojim uređajem, morate razumjeti opasnosti vezane uz električne sklopove, te biti upoznati sa standardnim načinima izbjegavanja nesreća. U prevedenim sigurnosnim upozorenjima, priloženima uz uređaj, možete prema broju koji se nalazi uz pojedino upozorenje pronaći i njegov prijevod.

SAČUVAJTE OVE UPUTE

Upozornění

DŮLEŽITÉ BEZPEČNOSTNÍ POKYNY

Tento upozorňující symbol označuje nebezpečí. Jste v situaci, která by mohla způsobit nebezpečí úrazu. Před prací na jakémkoliv vybavení si uvědomte nebezpečí související s elektrickými obvody a seznamte se se standardními opatřeními pro předcházení úrazům. Podle čísla na konci každého upozornění vyhledejte jeho překlad v přeložených bezpečnostních upozorněních, která jsou přiložena k zařízení.

USCHOVEJTE TYTO POKYNY

Προειδοποίηση

ΣΗΜΑΝΤΙΚΕΣ ΟΔΗΓΙΕΣ ΑΣΦΑΛΕΙΑΣ

Αυτό το προειδοποιητικό σύμβολο σημαίνει κίνδυνο. Βρίσκεστε σε κατάσταση που μπορεί να προκαλέσει τραυματισμό. Πριν εργαστείτε σε οποιοδήποτε εξοπλισμό, να έχετε υπόψη σας τους κινδύνους που σχετίζονται με τα ηλεκτρικά κυκλώματα και να έχετε εξοικειωθεί με τις συνήθεις πρακτικές για την αποφυγή ατυχημάτων. Χρησιμοποιήστε τον αριθμό δήλωσης που παρέχεται στο τέλος κάθε προειδοποίησης, για να εντοπίσετε τη μετάφρασή της στις μεταφρασμένες προειδοποιήσεις ασφαλείας που συνοδεύουν τη συσκευή.

ΦΥΛΑΞΤΕ ΑΥΤΕΣ ΤΙΣ ΟΔΗΓΙΕΣ

אזהרה

הוראות בטיחות חשובות

סימן אזהרה זה מסמל סכנה. אתה נמצא במצב העלול לגרום לפציעה. לפני שתעבוד עם ציוד כלשהו, עליך להיות מודע לסכנות הכרוכות במעגלים חשמליים ולהכיר את הנהלים המקובלים למניעת תאונות. השתמש במספר ההוראה המסופק בסופה של כל אזהרה כדי לאתר את התרגום באזהרות הבטיחות המתורגמות שמצורפות להתקן.

שמור הוראות אלה

Opomena

ВАЖНИ БЕЗБЕДНОСНИ НАПАТСТВИЈА

Симболот за предупредување значи опасност. Се наоѓате во ситуација што може да предизвика телесни повреди. Пред да работите со опремата, бидете свесни за ризикот што постои кај електричните кола и треба да ги познавате стандардните постапки за спречување на несреќни случаи. Искористете го бројот на изјавата што се наоѓа на крајот на секое предупредување за да го најдете неговиот период во преведените безбедносни предупредувања што се испорачани со уредот.
ЧУВАЈТЕ ГИ ОВИЕ НАПАТСТВИЈА

Ostrzeżenie WAŻNE INSTRUKCJE DOTYCZĄCE BEZPIECZEŃSTWA

Ten symbol ostrzeżenia oznacza niebezpieczeństwo. Zachodzi sytuacja, która może powodować obrażenia ciała. Przed przystąpieniem do prac przy urządzeniach należy zapoznać się z zagrożeniami związanymi z układami elektrycznymi oraz ze standardowymi środkami zapobiegania wypadkom. Na końcu każdego ostrzeżenia podano numer, na podstawie którego można odszukać tłumaczenie tego ostrzeżenia w dołączonym do urządzenia dokumencie z tłumaczeniami ostrzeżeń.

NINIEJSZE INSTRUKCJE NALEŻY ZACHOWAĆ

Upozornenie DÔLEŽITÉ BEZPEČNOSTNÉ POKYNY

Tento varovný symbol označuje nebezpečenstvo. Nachádzate sa v situácii s nebezpečenstvom úrazu. Pred prácou na akomkoľvek vybavení si uvedomte nebezpečenstvo súvisiace s elektrickými obvodmi a oboznámte sa so štandardnými opatreniami na predchádzanie úrazom. Podľa čísla na konci každého upozornenia vyhľadajte jeho preklad v preložených bezpečnostných upozorneniach, ktoré sú priložené k zariadeniu.

USCHOVAJTE SI TENTO NÁVOD



Warning

Read the installation instructions before you connect the system to its power source.



Warning

Ultimate disposal of this product should be handled according to all national laws and regulations.



Warning

Do not work on the system or connect or disconnect cables during periods of lightning activity.

**Warning**

To avoid electric shock, do not connect safety extra low voltage (SELV) circuits to telephone network voltage (TNV) circuits. LAN ports contain SELV circuits, and WAN ports contain TNV circuits. Some LAN and WAN ports use RJ-45 connectors. Use caution when connecting cables.

**Caution**

Inline power circuits provide current through the communication cable. Use the Cisco provided cable or a minimum 24 AWG communication cable.

Using an External Power Supply

The following warnings apply when you use the external power supply with the Cisco Unified IP Phone:

**Warning**

This product relies on the building's installation for short-circuit (over current) protection. Ensure that a fuse or circuit breaker no larger than 120 VAC, 15A U.S. (240 VAC, 10A international) is used on the phase conductors (all current-carrying conductors).

**Warning**

The device is designed to work with TN power systems.

**Warning**

The plug-socket combination must be accessible at all times because it serves as the main disconnecting device.

**Warning**

The power supply must be placed indoors.

**Caution**

Only use the Cisco-specified power supply with this product.

Power Outage

Your accessibility to emergency service through the phone is dependent on the phone being powered. If there is an interruption in the power supply, Service and Emergency Calling Service dialing will not function until power is restored. In the case of a power failure or disruption, you may need to reset or reconfigure equipment before using the Service or Emergency Calling Service dialing.

Accessibility Features

A list of accessibility features is available upon request.

Connecting Your Phone

Your system administrator will likely connect your new Cisco Unified IP Phone to the corporate IP telephony network. If that is not the case, refer to Figure 1 (Cisco Unified IP Phone 7905G) and Figure 2 (Cisco Unified IP Phone 7912G) and the tables that follow to connect your phone.

Figure 1 Cisco Unified IP Phone 7905G Cable Connections

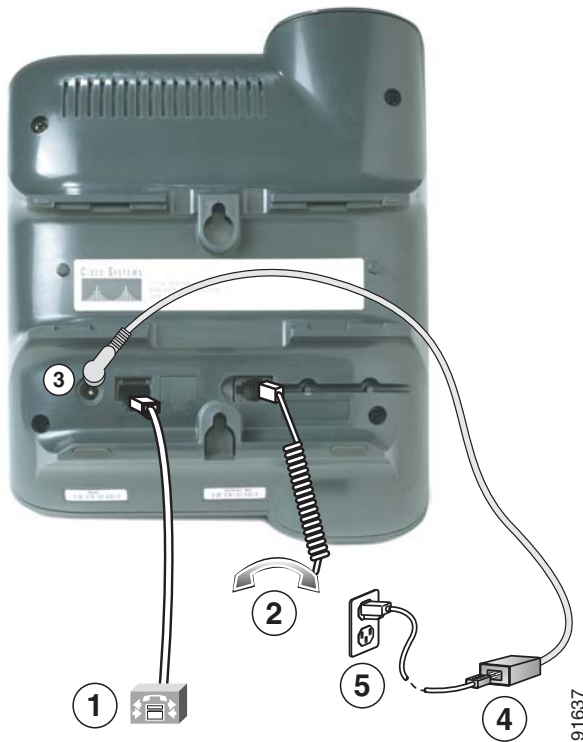

1	Network port (10BaseT)	4	Cisco-supplied power supply (optional)
2	Handset port	5	Power cable with wall socket plug
3	DC Adaptor port (DC48V)		

Figure 2 Cisco Unified IP Phone 7912G Cable Connections

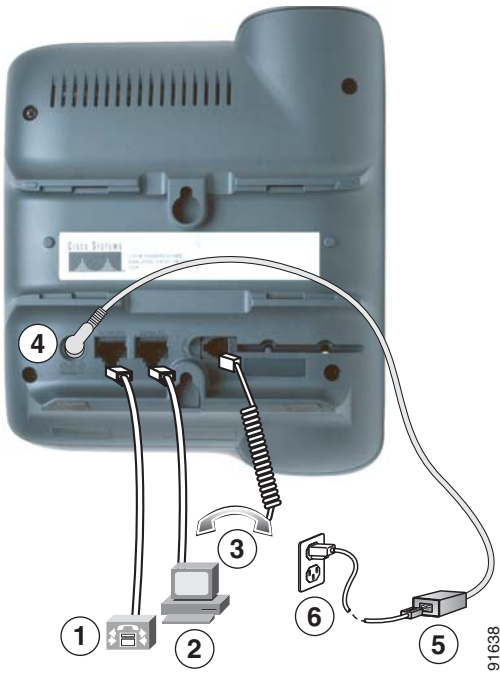

1	Network port (10/100 SW)	4	DC Adaptor port (DC48V)
2	Access port (10/100 PC)	5	Cisco-supplied power supply (optional)
3	Handset port	6	Power cable

Adjusting the Handset Rest

When you connect your phone, you might want to adjust the handset rest to ensure that the receiver will not slip out of the cradle. See the table below for instructions.

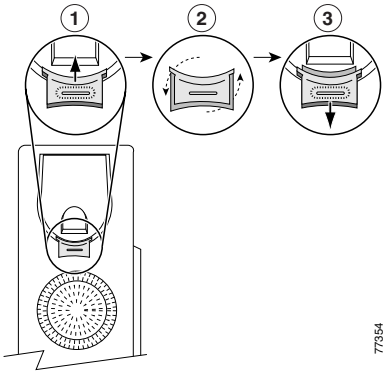

1	Set the handset aside and pull the square plastic tab from the handset rest.
2	Rotate the tab 180 degrees.
3	Slide the tab back into the handset rest. An extension protrudes from the top of the rotated tab. Return the handset to the handset rest.

Registering with TAPS

After your phone is connected to the network, your system administrator might ask you to auto-register your phone using TAPS (Tool for Auto-Registered Phones Support). TAPS might be used either for a new phone or to replace an existing phone.

To register with TAPS, pick up the handset, enter the TAPS extension provided by your system administrator, and follow the voice prompts. You might need to enter your entire extension, including the area code. After your phone displays a confirmation message, hang up. The phone will re-start.

An Overview of Your Phone

The Cisco Unified IP Phones 7905G and 7912G support:



- Voice communication over a data network
- Familiar telephony features to handle calls easily
- Special features to extend and customize your call-handling capabilities
- Online control from your User Options web pages
- Access to network data and services

Understanding Buttons and Hardware



91031

1	Phone screen	Displays features such as the time, date, your phone number, caller ID, call status, and softkey tabs.
2	Cisco Unified IP Phone series	Indicates your Cisco Unified IP Phone model number.

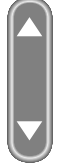
3	Softkeys	Enable you to engage any of the functions displayed on the corresponding phone screen tabs. Softkeys point to feature options displayed along the bottom of your phone screen. Softkey functions change depending on the status of your phone (for example, if the phone is active or idle).
4	Navigation button 	Enables you to scroll through text, highlight menu items, and select calls displayed on the phone screen. Also provides access to speed dial numbers.
5	Menu button 	Displays a menu that provides access to a voice messaging system, phone logs and directories, settings, and services.
6	Hold button 	Places the active call on hold, resumes a call on hold, and switches between an active call and an incoming call or an active call and a call on hold.
7	Keypad	Works exactly like the keypad on a traditional telephone.
8	Volume button 	Increases or decreases volume for the handset and speaker. Also controls the ringer volume (if on-hook).
9	Handset	Functions like a traditional handset. The light strip at the top of the handset blinks when the phone rings and remains lit to indicate new voice messages (depending on your message system).
10	Footstand	Allows the phone to stand at a convenient angle on a desk or table.

Understanding Feature Operation and Availability

The operation of your Cisco Unified IP Phone and the features available to you may vary, depending on the call processing agent used by your company and also on how your company's phone support team has configured your phone system. Therefore, some of the features included in this Phone Guide might not be available to you or might work differently on your phone system. Contact your support desk or system administrator if you have questions about feature operation or availability.

Call-Handling and Navigation Tips

These guidelines can help you handle calls and navigate menus on your Cisco Unified IP Phone.

Understanding Lines vs. Calls

It is sometimes easy to confuse *lines* and *calls* on your phone. Use these tips to avoid confusion:

Lines

The Cisco Unified IP Phone 7905G and 7912G are single-line phones, which means they support one line per phone extension. Your phone support team can configure your line to support from one to six calls. So you might find yourself handling several calls, even though you have only one line on your phone.

Calls

Calls can have different states. Only one call can be *active* at any given time. An active call is a connected call or a call in-progress (you are dialing a number or an outgoing call is ringing). Other calls must be ringing in, on hold, or remote in use (for shared lines).



Going On-Hook and Off-Hook

Some phone tasks and instructions differ depending on whether the phone is *on-hook* or *off-hook*.

- On-Hook—The phone handset is resting in the cradle, no calls are active, and you do not have an active dial tone. Your phone provides *on-hook dialing*, which enables you to enter or choose phone numbers before activating the call.
- Off-Hook—The phone handset is lifted from the cradle, or you have pressed **Dial** or **NewCall** to get a dial tone.

Choosing and Selecting Calls

Many phone features require that you select the calls you want to use with a particular feature. For example, you might have four held calls, but you only want to join two of them to a conference call. You can select just the calls you want to add to the conference call before activating the feature.

If you want to...	Then...
Choose a call 	Use the Navigation button to scroll through the call list until the pointer on the left side of the phone screen appears next to the call you want to choose.
Select a call 	Choose the call and then press more > Select to select the call. You may have to press the more key several times. Selected calls are indicated with a checkmark next to them. You can select multiple calls.

Switching Among Calls

Your phone can support up to six calls on one line, depending on how your system administrator has configured your phone. The following tips can help you switch among calls on your line. Use the **Navigation** button to scroll through the call list.

If you want to...	Then...
View current calls on a line	See your phone screen.
Switch between calls on one line	Use the Navigation button to select the desired call and press the Hold button.
Switch from a connected call to answer a ringing call	Press Answer . Doing so answers the new call and automatically places the first call on hold.

Tips

- Only one call can be active at any given time; other calls will be placed on hold automatically.
- When you have multiple calls on one line, calls with the highest precedence and longest duration display at the top of the call list.
- Incoming calls are initially shown on the top of the display but move to the bottom once you answer them.

Using Feature Menus

The following can help you use feature menus.

If you want to...	Then...
Access the feature menus	Press the Menu button to display Messages, Directories, Settings, and Services feature menus.
Scroll through a list or menu	Press the Navigation button.
Select a menu item	Use the Navigation button to scroll to a menu item, then press Select . Or press the number key on your phone's keypad that corresponds to the number displayed next to the menu item.
Go back one level in a feature menu	Press Exit . (Note that if you press Exit from the top-level of a menu, the menu will close.)
Close a feature menu	Press Exit one or more times until the menu closes.
Exit all menus	Press the Menu button.

Entering and Editing Text

The following can help you edit or enter text on your keypad.

If you want to...	Then...
Enter a letter on your phone display	Press the appropriate keypad number one or more times to select a letter (with or without capitalization). When you pause, the cursor automatically advances to allow you to enter the next letter.
Delete within an entry or move your cursor	Press << or Delete to remove a letter or digit. Press >> to move the cursor to the right.

Basic Call Handling

This section covers basic call-handling tasks such as placing, answering, and transferring calls.

Placing a Call

To place a call, use one of several options to go off-hook before or after dialing a number.

If you want to...	Then...
Dial off-hook	Lift the handset and dial the number.
Dial on-hook (without dial tone)	<p>Enter or choose a phone number by:</p> <ul style="list-style-type: none"> • Entering a phone number on the keypad. • Pressing the Navigation button to access and choose phone numbers from your list of speed dial numbers. <p>Then, to place the call, do one of these things to go off-hook:</p> <ul style="list-style-type: none"> • Lift the handset. • Press Dial.
Dial on-hook (with dial tone)	Press NewCall and dial the number.
Redial the most recently dialed number	Press Redial .
Speed dial a number	<p>Do one of the following:</p> <ul style="list-style-type: none"> • Press the Navigation button to choose a number from your list of speed dial numbers and then press Dial. • Press the Menu button and select Directories > Speed Dials. Select a number to dial. • Enter a speed dial index number (1-99 on the keypad) while on-hook and press AbbrDial. <p>For details, see the “Speed Dialing” section on page 30.</p>
Dial from a call log	<p>Press the Menu button and select Directories > Missed Calls, Received Calls, Placed Calls, Speed Dial, or Directory Services. To dial from a listing, scroll to it and go off-hook.</p> <p>To add a prefix or other digits to the number before dialing, press EditDial.</p>

If you want to...	Then...
Dial from a corporate directory	Press the Menu button and select Directories > Directory Services > Corporate Directory . Search for a listing by using your keypad to enter letters. (You can search using a partial name.) Press Submit . To dial from a listing, scroll to it and go off-hook.
Dial from a corporate directory web page	Use the Cisco Webdialer feature. Open a web browser and go to your company directory. Click on a phone number in the directory. Click Dial to place the call. Click Hangup to end the call.
Place a call when another call is active	Press the Hold button. Then dial, redial, or speed dial a number.
Receive notification when a busy or ringing extension becomes available	<p>Call the number and press CallBack while listening to the busy tone or ring sound. Hang up. When the extension becomes available, your phone will provide you with an audio and visual alert. (The call back to this number is not automatic; you must place the call.) To view the status of call back notification, press CallBack while the phone is idle. To cancel call back notification, press Cancel.</p> <p>CallBack is a special feature that your system administrator might configure for your phone. You will not have access to this feature by default.</p>
Make a priority (precedence) call	Enter the MLPP access number (which is provided by your system administrator) followed by the phone number. For more details, see the “Prioritizing Critical Calls” section on page 35.
Dial from a Personal Address Book (PAB) entry or Fast Dial code	<p>Press the Menu button and select Services > PABookService or My Fast Dial (exact names might vary). To dial from a listing, scroll to it and go off-hook.</p> <p>For help subscribing to the PAB or Fast Dial service, see the “Using Personal Directory on Your Phone” section on page 42.</p>
Place a call using a billing or tracking code	Dial a number and enter a client matter code (CMC) or a forced authorization code (FAC) when prompted by a distinctive tone. Your system administrator will tell you if you need to enter CMC or FAC codes and can provide you with detailed instructions.
Place a call using your Cisco Extension Mobility profile	<p>Make sure that you are logged in to Extension Mobility (EM). Press the Menu button and choose Services > EM Service (exact name might vary), then use your keypad to enter login information. If you are sharing a phone, you might need to log in to EM before you can access certain features or complete a call.</p> <p>EM is a special, non-default feature that your system administrator can assign to phones and phone users.</p>

Tips

- If you make a mistake while entering a phone number, press << to erase one or more digits. Press **Cancel** to exit the dialing attempt, or hang up.
- If you are dialing with the phone on-hook, you cannot use * or # as the leading digit. If you need to use these keys, dial with the phone off-hook.
- You cannot activate call back notification if the called party has forwarded all calls to another extension.
- You may not be able to place a call when another call is active if you reach the maximum number of calls configured for your line.
- If your system administrator has disabled the speaker for your phone, you cannot use the on-hook dialing features.

Answering a Call

To answer a call, pick up the handset. See the table below for more options.

If you want to...	Then...
Switch from a connected call to answer a ringing call	Press Answer . Doing so answers the new call and automatically places the first call on hold. See the “Using the Hold Button” section on page 25 for more information.
Answer a call using call waiting	<p>Ask your system administrator to setup the Call Waiting feature for your phone.</p> <p>When this feature is enabled, you will hear a call waiting tone and see caller ID information if a new call comes in while you are on another call. To answer the call, press Answer. To return to the original call, use the Navigation button to select the desired call and then press the Hold button.</p> <p>To switch between calls, use the Navigation button to select the desired call and then press the Hold button to resume. To create a conference call between yourself and the other two parties, select the desired calls and press Join.</p>
Automatically connect to an incoming call after a ring or two	Ask your system administrator to set up the Auto Answer feature. Keep your handset in the cradle and the incoming call connects after ringing once or twice. You must pick up the handset to talk with the caller.
Retrieve, or allow someone else to retrieve, a held call on another phone (such as a phone in a conference room)	Use Call Park. See the “Storing and Retrieving Parked Calls” section on page 31.

If you want to...	Then...
Use your phone to answer a call that is ringing on another phone	Use Call Pickup. See the “Understanding Shared Lines” section on page 33.
Send an incoming call directly to the voice messaging system.	Press iDivert . The incoming call automatically transfers to your voice message greeting.

Ending a Call

To end a call, hang up the handset or press **EndCall**.



Note If you press **End Call**, you do not have to put the handset back in the cradle to end the call. When the handset is not in the cradle, the off-hook icon will appear on the screen although there are no active calls.

Using the Speaker

The Cisco Unified IP Phone 7905G and 7912G each provide a speaker for hands-free listening. You can use the speaker only to listen to a call. To talk on a call, you must pick up the handset.

If you want to...	Then...
Listen to the other party on the speaker	Press Monitor and then hang up the handset. You will be able to hear the call but you will not be able to talk on the call.
Listen to the other party using the handset	Lift the handset or press MonOff .
Turn off the speaker and hang up	Press EndCall .
Adjust the volume on the speaker	Press the up or down Volume button when the speaker is in use. If you want to save the speaker volume setting, press Save .



Tip If your system administrator has disabled the speaker on your phone, the **Monitor** and **MonOff** softkeys will not be available to you. You must lift the handset to place and monitor calls.

Using the Hold Button

Only one call can be active at any given time; all other connected calls must be placed on hold.

If you want to...	Then...
Put a call on hold	Select the call you want to put on hold and press the Hold button. The button turns red and the caller ID information flashes on the phone screen.
Remove a call from hold	Select the call you want to remove from hold and press the Hold button. The button light turns off.

Tips

- Engaging the Hold feature typically generates music or a beeping tone. For this reason, avoid putting a conference call on hold.
- When you have multiple calls on one line, the active call always appears at the top of the phone screen. Held calls appear below.
- You can put up to six calls on hold, depending on how many calls are configured for your line. If you need more calls configured for your line, ask your phone support team.

Transferring a Connected Call

Transfer redirects a connected call. The *target* is the number to which you want to transfer the call.

If you want to...	Then...
Transfer a call without talking to the transfer recipient	Press Trnsfer and enter the target number. When you hear the call ringing, hang up. If your system administrator did not enable on-hook transfer, you must press Trnsfer again to complete the transfer. To cancel the transfer, press EndCall .

If you want to...	Then...
Talk to the transfer recipient before transferring a call (consult transfer)	<p>Press Trnsfer and enter the target number. Wait for the transfer recipient to answer. If the recipient accepts the transferred call, press Trnsfer again. If the recipient refuses the call, press EndCall and then the Hold button to return to the original call.</p> <p>If your system administrator did not enable on-hook transfer, you must press Trnsfer again to complete the transfer. To cancel the transfer, press EndCall.</p>
Transfer two current calls to each other (direct transfer) without staying on the line	<p>Scroll to highlight any call on the line and press Select. Repeat this process for the second call. With one of the selected calls highlighted, press DirTrfr. (You might need to press more to see DirTrfr.) The two calls connect to each other and drop you from the call.</p> <p>If you want to stay on the line with the callers, use Join to create a conference instead. For details, see the “Making Conference Calls” section on page 26.</p>

Tips

- When on-hook transfer is enabled, you can either hang up or press **Trnsfer**, then hang up.
- If on-hook transfer is not enabled on your phone, be aware that hanging up instead of pressing **Trnsfer** cancels the transfer action and places the party to be transferred on hold.
- You cannot use **Trnsfer** to redirect a call on hold. Press **Hold** to remove the call from hold before transferring it.

Making Conference Calls

Conference calling allows three or more parties to participate in a call simultaneously. Your Cisco Unified IP Phone can support several types of conference calls depending on your needs and your phone’s configuration. The following conference softkeys may be available on your phone:

- **Confrn**—Use this softkey to establish conferences (3-16 participants) by calling each participant individually. Standard conference calling is a default feature.
- **Join**—Use this softkey to establish a conference (3-16 participants) among several current calls on a single line. Standard conference calling is a default feature available on most phones.
- **cBarge**—Use this softkey to begin a conference call (3-16 participants) on a shared line. This is an optional feature available only for shared lines, and your system administrator must configure it for you.
- **MeetMe**—Use this softkey to host a conference (up to 100 participants, depending on your configuration) Meet-Me conferences require participants to call an established number at a specific time. This is an optional feature that your system administrator must configure for you. See “Starting or Joining a Meet-Me Conference Call” section on page 28 for more details.

Starting or Joining a Standard Conference Call

Some of the conference features in the table below might not be available to you depending on how your system administrator configured your phone.

If you want to...	Then...
Invite current callers to join a conference	Choose any call on the line and press Select . Repeat this process for each call you want to add to the conference. From one of the selected calls, press more > Join . The selected calls are automatically added to the conference.
Start a conference call by calling participants	During a connected call, press more > Confm to add another party to the call. Enter the conference participant's phone number. After the call connects and you have spoken to the conference participant, press Confm again to add this party to your call. Follow this procedure to add each participant.
Join a conference call	Answer the phone when it rings. You do not need to do anything special to join a conference call.
Join a conference call using a shared line	On the remote phone that is a shared line, choose the call you want to join and press cBarge .
View a list of conference participants	Choose an active conference and press ConfList . Participants are listed in the order in which they join the conference, from bottom to top.
Get an updated list of conference participants	While viewing the conference list, press Update .
See who started the conference	While viewing the conference list, locate the person listed at the bottom of the list with an asterisk (*) next to his/her name.
Remove any conference participant	Scroll to highlight the participant's name and press Remove . You can remove participants only if you initiated the conference call.
Drop the last party added to a standard conference	Press RmLstC or scroll to highlight the participant's name at the top conference list and press Remove . The last participant to enter the conference is always listed at the top of the list. You can remove participants only if you initiated the conference call.
End a conference	Hang up or press EndCall .

Tips

- Engaging the Hold feature generates music or a beeping tone. For this reason, avoid putting a conference call on hold.
- If you get an error stating “No Participant Info” when attempting to use **Join**, be sure that you have selected at least one call in addition to the active call.

Starting or Joining a Meet-Me Conference Call

Meet-Me conferencing allows participants to join a conference by calling the conference number directly, rather than waiting for the conference initiator to call them.

To start a Meet-Me conference, use the MeetMe softkey on your phone, then dial the Meet-Me phone number provided to you by your system administrator. To participate in a Meet-Me conference, dial the Meet-Me phone number at a specified time. Conference participants hear a busy tone if they call into the conference before the conference initiator has dialed in. Once the conference initiator has dialed in, the Meet-Me conference is established and can continue even if the conference initiator disconnects.

If you want to...	Then...
Establish a Meet-Me conference	Press NewCall or go off-hook and press more > MeetMe . Dial the Meet-Me conference number. (See your system administrator for a list of valid numbers.) Note: Remember to inform participants about the conference number, so they can dial in. However, participants will hear busy tone if they call the conference number before you have dialed in.
Join a Meet-Me conference	Dial the Meet-Me conference number provided by the Meet-Me conference initiator. You can join the conference only after the initiator has dialed in.
End a Meet-Me conference	Hang up or press EndCall .

Forwarding Your Calls to Another Number

You can use Call Forward All to redirect your incoming calls from your Cisco Unified IP Phone to another number.



Tip Enter the Call Forward All target number exactly as you would need to dial it from your desk phone. For example, enter an access code such as 9 or the area code, if necessary.

If you want to...	Then...
Set up call forwarding from your phone	Press more > CFwdAll and enter a target phone number. The screen displays “Forwarded to <target number>.”
Cancel call forwarding from your phone	Press more > CFwdAll . The “Forwarded to <number>” message disappears.

If you want to...	Then...
Set up or cancel call forwarding using your computer	Log in to your User Options web page, select your device, then choose Forward all calls to a different number from the main menu. You can set up or cancel call forwarding from the Call Forwarding web page. (See the “Accessing Your User Options Web Pages” section on page 45 for login instructions.)
Verify that call forwarding is enabled	Look at the call state icon for the line. When call forwarding is enabled, an animated arrow displays over the phone icon and a message appears in the status area indicating the number to which calls are forwarding.

Tips

- You can forward your calls to a traditional analog phone or to another IP phone, although your system administrator might restrict the call forwarding feature to numbers within your company.
- You can always cancel call forwarding from your phone, even if you set it up from your User Options web page.

Advanced Call Handling

Advanced call-handling tasks involve special features that your system administrator might configure for your phone depending on your call-handling needs and work environment.

Speed Dialing

Speed dialing allows you to enter an index number, press a button, or select a phone screen item to place a call. Depending on configuration, your phone can support several speed-dial features:

- Speed-dial buttons
- Abbreviated dialing
- Fast Dials



Note To set up speed-dial buttons and Abbreviated Dial, you must access your User Options web pages. See the “Accessing Your User Options Web Pages” section on page 45.

To set up Fast Dials, you must access the Personal Directory feature. See the “Using Personal Directory on Your Phone” section on page 42.

Alternately, your system administrator can configure speed-dial features for you.

If you want to...	Then...
Use speed-dial buttons	<ol style="list-style-type: none">1. Set up speed-dial buttons. See the “Setting Up Speed Dials on the Web” section on page 48.2. To place a call, do one of the following:<ol style="list-style-type: none">a. Press a speed-dial button.b. Press the Menu button, then choose Directories > Speed Dials. Select a number to dial.

If you want to...	Then...
Use Abbreviated Dialing	<ol style="list-style-type: none"> <li data-bbox="467 191 1266 250">1. Set up Abbreviated Dialing codes. See the “Setting Up Speed Dials on the Web” section on page 48. <li data-bbox="467 261 1266 319">2. To place a call, enter the Abbreviated Dialing code and press AbbrDial.
Use Fast Dial	<ol style="list-style-type: none"> <li data-bbox="467 339 1266 397">1. Create a Personal Address Book entry and assign a Fast Dial code. See the “Using Personal Directory on the Web” section on page 46. <li data-bbox="467 409 1266 467">2. To place a call, access the Fast Dial service on your phone. See the “Using Personal Directory on Your Phone” section on page 42.

Storing and Retrieving Parked Calls

You can “park” a call when you want to store the call so that you or someone else can retrieve it from another phone in the Cisco Unified CallManager system (for example, at a co-worker’s desk or in a conference room).

Call Park is a special feature that your system administrator might configure for you.

If you want to...	Then...
Store an active call using Call Park	During a call, select more > Park . The phone screen displays the special call park number at which the call is stored. Make a note of the call park number and hang up.
Retrieve a parked call	Enter the call park number from any Cisco Unified IP Phone in your network to connect to the call.



Note

You have a limited amount of time to retrieve the parked call before it reverts to ringing at its original destination. See your system administrator for this time limit.

Picking Up a Redirected Call on Your Phone

Your system administrator might enable Call PickUp for your phone if you share call-handling responsibilities with co-workers. Call PickUp allows you to answer a call that is ringing on a co-worker's phone by redirecting the call to your phone. You can use Call PickUp features to handle calls for co-workers who are in your call pickup group (**PickUp**), who are in another pickup group (**GPickUp**), or who are in a group associated with your group (**OPickUp**).

If you want to...	Then...
Answer a call that is ringing on another extension within your call pickup group	Press PickUp to connect to the call. (You might have to go off-hook to press PickUp .) If your system administrator did not enable auto-pickup, the call will ring on your phone when you press PickUp . In this case, press Answer to connect to the call.
Answer a call that is ringing on another extension outside of your group	Press GPickUp . (You might have to go off-hook to press GPickUp .) Enter the group pickup code provided by your system administrator to connect to the call. If your system administrator did not enable auto-pickup, the call will ring on your phone when you press GPickUp and enter the group pickup code. In this case, press Answer to connect to the call.
Answer a call that is ringing on another extension in your group or in an associated group	Press OPickUp to connect to the call. (You might have to go off-hook to press OPickUp .) If your system administrator did not enable auto-pickup, the call will ring on your phone when you press OPickUp . In this case, press Answer to connect to the call.

Tips

- When you press **PickUp** and **GPickUp**, you connect to the call that has been ringing for the longest time.
- With **OPickUp**, your system administrator can associate multiple call pickup groups with your group and assign a priority to the groups. When you press **OPickUp**, you connect to the ringing call in the pickup group with the highest priority.

Understanding Shared Lines

Your system administrator might give you a “shared” line. Shared line features do not apply to standard, unshared lines. Typically, a shared line has two main uses:

- One person applies a shared line to multiple phones—For example, your shared line, extension 23456, applies to your desk phone and your lab phone. An incoming call to extension 23456 rings on your desk and lab phone, and you can use either of the phones to answer the call.
- Multiple people share a line—For example, you are a manager who shares a line and extension number with your assistant. An incoming call to the extension rings on both of your phones.

Remote-In-Use

You can make calls using a shared line just as you would using any other line — even when your phone displays “remote-in-use”. Remote-in-use indicates that a co-worker who is sharing your line is using their phone. When your phone displays “remote-in-use”, you may also see information about your co-worker’s call such as the called party and call duration. Conversely, when you are using a shared line, information about your call may be displayed on your co-worker’s phone. If you are sharing a line and do not want other people to see information about your calls, enable the Privacy feature for your phone. See “Preventing Others from Viewing or Joining a Shared-Line Call” section on page 34 for details about how to use the Privacy feature with a shared line.



Tip

If you have Privacy enabled on a shared line and make a call, “remote-in-use” will not be displayed on other phones that share the line.

Maximum Supported Calls on a Shared Line

Your system administrator can configure your shared line to support a different number of calls than your co-workers who share the line with you. Thus, at times you might not be able to make a new call on the shared line even if your co-worker can.

For example, you have a shared line extension, 78888, and your phone is configured to support a maximum of four calls on that shared line. However, one of your co-workers has a phone that supports a maximum of five calls on the same shared line, 78888. If there are already four active calls on the shared line, the **NewCall** softkey is unavailable to you, and you cannot make a new call using the shared line. However, your co-worker would be able to make a new call on the shared line because her phone supports a maximum of five calls on the shared line, not just four.

Adding Yourself to a Shared-Line Call

If you use a shared line, you can use cBarge to join an in-progress call and convert it to a standard conference. This gives you and all call participants the same features available in standard conferences (see the “Making Conference Calls” section on page 26 for details), and you can add additional participants to the call.

When you use cBarge, other parties on the call hear a tone and brief interruption in the call, and call information changes on the screen. When you hang up, the call remains as a conference call provided at least three participants remain.



If you want to...	Then...
View active calls on the shared line	Look at your phone screen. If “remote-in-use” displays, there are active calls on the shared line. Information for all non-private calls displays. However, if a co-worker who is sharing your line has Privacy enabled and has active calls, you do not see any indication that the line is in use.
Add yourself to a remote-in-use call and establish a conference call	Choose the remote-in-use call you want to join and press cBarge .



Note You cannot use **cBarge** to join an in-progress call if the initiator has Privacy enabled.

Preventing Others from Viewing or Joining a Shared-Line Call

If you use a shared line, you can use the Privacy feature to prevent others who share this line from viewing or joining your calls on this line.

If you want to...	Then...
Turn on the Privacy feature to prevent others from viewing or joining any calls on a shared line	Press more > Private . When Privacy is turned on, the privacy-on icon  displays next to your phone number on the phone screen.
Turn off the Privacy feature to allow others to view or join any calls on a shared line	Press more > Private . When Privacy is turned off, the privacy-off icon  displays next to your phone number on the phone screen.

Tips

- If you have Privacy enabled on a shared line and make a call, “remote-in-use” will not be displayed on other phones that share the line; there is no indication when the line is in use.

- If all other phones that share the same line have Privacy enabled, you can still make new calls using the shared line. However, you cannot join any in-progress calls using the shared line.

Tracing Suspicious Calls

If you are receiving suspicious or malicious calls, your system administrator can add the Malicious Call Identification (MCID) feature to your phone. This feature enables you to identify an active call as suspicious, which initiates a series of automated tracking and notification messages.

If you want to...	Then...
Identify a suspicious call	Press MCID . If the MCID request is successful, you will hear a special tone and see the message, “MCID successful” on your phone. The call remains active until you end the call.

Prioritizing Critical Calls

In some specialized environments, such as military or government offices, you might need to make and receive urgent or critical calls. These critical calls might require higher priority handling, such as being able to bypass other calls. If you have the need for this specialized call handling, your system administrator can add Multilevel Precedence and Preemption (MLPP) to your phone.

Keep these terms in mind:

- *Precedence* indicates the priority associated with a call.
- *Preemption* is the process of ending an existing, lower priority call while accepting a higher priority call that is sent to your phone.

If you want to...	Then...
Choose a priority (precedence) level for an outgoing call	Contact your system administrator for a list of corresponding precedence numbers for calls (ranging from low to highest).
Make a priority (precedence) call	Enter the MLPP access number (which is provided by your system administrator) followed by the phone number.
Receive a priority (precedence) call	Hear the special call waiting tone and note the special icon displayed for the incoming call.

If you want to...	Then...
View the priority level of a call	<p>Higher priority calls display at the top of your call list. The following icons indicate the assigned priority:</p> <p>(no icon) Normal (routine) call</p> <ul style="list-style-type: none"> ▣ Priority call ▣ Medium priority (immediate) call ▣ High priority (flash) call ▣ Highest priority (flash override) call
Accept a higher-priority call	When you hear the special call waiting tone, end the active call and answer the higher-priority call.
Receive a preemption call	While on an active call, you hear a continuous tone for about 10 seconds. The preemption call then overrides the active call.

Tips

- When you make or receive an MLPP-enabled call, you will hear special ring tones and call waiting tones that differ from the standard tones.
- If you enter an invalid MLPP access number, a verbal announcement will alert you of the error.

Using Cisco Extension Mobility

Cisco Extension Mobility (EM) allows you to temporarily configure a Cisco Unified IP Phone as your own. Once you log in to EM, the phone adopts your user profile, including your phone lines, features, established services, and web-based settings. Your system administrator must configure EM for you.

If you want to...	Then...
Log in to EM	<ol style="list-style-type: none"><li data-bbox="560 404 1264 430">1. Choose Menu > Services > EM Service (name can vary).<li data-bbox="560 444 1264 500">2. Enter your user ID and PIN (provided by your system administrator).
Log out of EM	<ol style="list-style-type: none"><li data-bbox="560 519 1264 545">1. Choose Menu > Services > EM Service (name can vary).<li data-bbox="560 560 1264 586">2. When prompted to log out, press Yes.

Using Phone Settings

You can personalize your Cisco Unified IP Phone by adjusting settings, as described in the tables below.



Note

- Most settings are accessible on your phone, but a few are accessed online from your User Options web pages. See the “Customizing Your Phone on the Web” section on page 45 for more information.
 - If you want to restore your previously saved settings on the phone, choose **Settings > more > Restore**.
 - If you want to restore these settings back to those originally stored on the phone when it was manufactured, choose **Settings > more > Factory**. All your previously saved changes will be reset.
-

Adjusting the Volume

The table below describes how to adjust and save volume levels on your phone.

If you want to...	Then...
Adjust the volume level for a call 	Press the Volume button during a call or after invoking a dial tone. Doing so adjusts the volume level for the currently active audio mode. For example, if you increase the volume while you are using the handset, you have not affected the speaker volume. Press Save to preserve the new volume as the default level for this audio mode. If you want your phone to keep this volume setting even after a reboot, press the Menu button and choose Settings > Save .
Adjust the volume level for the ringer	Press the Volume button while the handset is in the cradle. The new ringer volume is saved automatically.



Tip

If you adjust the handset or speaker volume without saving the change, the volume will revert to the previously saved level the next time you use that audio mode.

Customizing Rings

You can change the sound your phone makes when it rings to suit your tastes and to help you differentiate between your phone ringing and another nearby phone.

If you want to...	Then...
Change the ring sound	Press the Menu button and select Settings > Ring Type . Use the Navigation button to scroll through the ring types and press Play to hear the selected ring type. When you find the ring you want, press Select and OK .

Using Voice Messaging, Call Logs, and Directories

This section describes how you can access voice messages, call logs, and directories.

Accessing Voice Messages



Note Your company determines the voice message service that your phone system uses. For the most accurate and detailed information about using the voice message service, see the documentation that came with it.

If you want to...	Then...
Set up and personalize your voice message service	Press Message and follow the voice instructions. You can also set up voice messaging by pressing the Menu button and selecting Messages . Your system administrator will provide you with a default password for your voice message service. For security reasons, you should change your default password as soon as possible.
See if you have a new voice message	Look to see if there is a red light on your handset.
Listen to your voice messages or access the voice messages menu	Press Message and follow the voice instructions. You can also access the voice messaging system by pressing the Menu button and selecting Messages .
Send a call to your voice message system	Press iDivert . The iDivert feature automatically transfers a call (including a ringing or held call) to your voice message system. Callers hear your voice message greeting and can leave you a message.

Using Call Logs

This section describes how you can use call logs. To access this feature, Press the **Menu** button and select **Directory**.

If you want to...	Then...
View your call logs	Press the Menu button and select Directory > Missed Calls, Placed Calls, or Received Calls . A maximum of 100 records are stored in each of these logs.
Dial from a call log (while not on another call)	<ol style="list-style-type: none"> 1. Press the Menu button and select Directory > Missed Calls, Placed Calls, or Received Calls. 2. Highlight a call record from the log. 3. If you need to edit the number, press EditDial followed by << or >>. 4. Go off-hook to place the call.
Dial from a call log (while connected to another call)	<ol style="list-style-type: none"> 1. Press the Menu button and select Directory > Missed Calls, Placed Calls, or Received Calls. 2. Highlight a call record from the log. 3. If you need to edit the number, press EditDial followed by << or >>. 4. Press Dial. The original call goes on hold. 5. Choose one of the following: <ul style="list-style-type: none"> • Transfer—Transfers the first party to the second and drops you from the call. (Press Transfer again after dialing to complete the action.) • Conference—Creates a conference call with all parties, including you. (Press Confrn again after dialing to complete the action.)
Erase your call log	Press the Menu button and choose Directory > Clear .

Directory Dialing

Depending on configuration, your phone can provide corporate and personal directory features:

- **Corporate Directory**—A directory of corporate contacts that is set up and maintained by your system administrator.
- **Personal Directory**—A feature set that is comprised of Personal Address Book (PAB) and Fast Dials.
 - PAB is a directory of your personal contacts that you can maintain and access on your phone or from your User Options web pages.
 - Fast Dials allows you to assign codes to PAB entries for quick dialing.

To access these feature, Press the **Menu** button and select **Directory > Directory Services**.

Using Corporate Directory on Your Phone

You can use a corporate directory to place calls to coworkers.

If you want to...	Then...
Dial from a corporate directory (while not on another call)	<ol style="list-style-type: none">1. Press the Menu button and select Directory > Directory Services > Corporate Directory (exact name can vary).2. Use your keypad to enter a full or partial name and press Search.3. To dial, press the listing, or scroll to the listing and go off-hook.
Dial from a corporate directory (while on another call)	<ol style="list-style-type: none">1. Press the Menu button and select Directory > Directory Services > Corporate Directory (exact name can vary).2. Use your keypad to enter a full or partial name and press Search.3. Scroll to a listing and press Dial. The original call goes on hold.4. Choose one of the following:<ul style="list-style-type: none">• Transfer—Transfers the first party to the second and drops you from the call. (Press Transfer again after dialing to complete the action.)• Conference—Creates a conference call with all parties, including you. (Press Confrn again after dialing to complete the action.)

Tip

Use the numbers on your keypad to enter characters on your phone screen. Use the Navigation button on your phone to move between input fields.

Using Personal Directory on Your Phone

The Personal Directory feature set contains your Personal Address Book (PAB) and Fast Dials. This section describes how to set up and use Personal Directory on your phone. Alternately, see the “Using Personal Directory on the Web” section on page 46.

If you want to...	Then...
Access Personal Directory (for PAB and Fast Dial codes)	<ol style="list-style-type: none">1. Press the Menu button and select Directory > Directory Services > Personal Directory (exact name can vary).2. Enter your Cisco Unified CallManager user ID and password, then press Submit.
Search for a PAB entry	<ol style="list-style-type: none">1. Access Personal Directory, then choose Personal Address Book.2. Enter search criteria and press Submit.3. You can choose Previous or Next to move through listings.4. Highlight the PAB listing that you want and press Select.

If you want to...	Then...
Dial from PAB entry	<ol style="list-style-type: none"> 1. Search for a listing. 2. Highlight the listing and press Select. 3. Press Dial. (You may need to press the more softkey to see Dial.) 4. Enter the participant's phone number. 5. Highlight the number that you want to dial (Home, Work, or Mobile) and press OK. 6. Press OK again to dial the number.
Delete a PAB entry	<ol style="list-style-type: none"> 1. Search for a listing. 2. Highlight the listing and press Delete. 3. Choose OK to confirm the deletion.
Edit a PAB entry	<ol style="list-style-type: none"> 1. Search for a listing. 2. Highlight the listing and press Edit to modify a name or email address. 3. If necessary, choose Phones to modify a phone number. 4. Press Update.
Add a new PAB entry	<ol style="list-style-type: none"> 1. Access Personal Directory, then choose Personal Address Book. 2. Access the Search page by choosing Submit. (You do not need to input search information first.) 3. Press New. 4. Use your phone keypad to enter a name and email information. 5. Choose Phones and use the keypad to enter phone numbers. Be sure to include any necessary access codes such as a 9 or 1. 6. Choose Submit to add the entry to the database.
Assign a Fast Dial code to a PAB entry	<ol style="list-style-type: none"> 1. Search for a PAB entry. 2. Highlight the listing and press Select. 3. Press Fast Dial. 4. Highlight the number that you want to dial (Home, Work, or Mobile) and press Select. 5. Highlight the Fast Dial code that you want to assign to the number and press Select.

If you want to...	Then...
Add a new Fast Dial code (not using a PAB entry)	<ol style="list-style-type: none"> 1. Press the Menu button and select Directory > Directory Services > Personal Directory > Personal Fast Dials. 2. Press Fast Dial. 3. Highlight a Fast Dial code that is unassigned and press Select. 4. Press Assign. 5. Enter a phone number. 6. Press Update.
Search for Fast Dial codes	<ol style="list-style-type: none"> 1. Press the Menu button and select Directory > Directory Services > Personal Directory > Personal Fast Dials. 2. You can choose Previous or Next to move through listings. 3. Highlight the listing that you want and press Select.
Place a call using a Fast Dial code	<ol style="list-style-type: none"> 1. Search for a Fast Dial code. 2. Highlight the listing you want and press Select. 3. Press Dial. 4. Choose OK to complete the action.
Delete a Fast Dial code	<ol style="list-style-type: none"> 1. Search for a Fast Dial code. 2. Highlight the listing you want and press Select. 3. Press Remove.

Tips

- To log in to Personal Directory, enter the user ID and password that you use to access your User Options web pages on your computer. See your system administrator for more information.
- Use the numbers on your keypad to enter characters on your phone screen. Use the Navigation button on your phone to move between input fields.

Customizing Your Phone on the Web

Your Cisco Unified IP Phone is a network device that can share information with other network devices in your company, including your personal computer. You can use your computer to log in to your Cisco Unified CallManager User Options web pages, where you can control features, settings, and services for your Cisco Unified IP Phone. For example, you can set up speed-dial buttons from your User Options web pages.

Accessing Your User Options Web Pages

This section describes how to log in and select a phone device.

If you want to...	Then do this...
Log in to your User Options web pages	<ol style="list-style-type: none"> 1. Obtain a User Options URL, user ID, and default password from your system administrator. 2. Open a web browser on your computer, enter the URL, and log on. 3. If prompted to accept security settings, click Yes or Install Certificate. <p>The Cisco Unified CallManager User Options main web page displays. From this page you can choose User Options to access User Settings, Directory features, a Personal Address Book, and Fast Dials.</p> <p>Or, to access phone-specific options, select a device (see below).</p>
Select a device after logging in	<ol style="list-style-type: none"> 1. After you have logged in to your User Options web pages, choose User Options > Device. <p>The Device Configuration page displays.</p> <ol style="list-style-type: none"> 2. If you have multiple devices assigned to you, verify that the appropriate device (phone model or Extension Mobility profile) is selected. If necessary, choose another device from the Name drop-down menu. <p>From the Device Configuration page, you can access all of the various configuration options available for your phone (other pages might not provide access to all options).</p> <ul style="list-style-type: none"> – Choose User Options to access User Settings, Directory, Personal Address Book, and Fast Dials. – Choose toolbar buttons to access phone-specific options, such as line settings, phone service settings, and speed dials. <p>To return to the Device Configuration page from another page, choose User Options > Device.</p>

Configuring Features and Services on the Web

The topics in this section describe how to configure features and services from your User Options web pages after logging in. See the “Accessing Your User Options Web Pages” section on page 45.

Using Personal Directory on the Web

The Personal Directory feature set consists of:

- A Personal Address Book (PAB)
- Fast Dials
- Cisco Unified CallManager Address Book Synchronizer



Note You can also access PAB and Fast Dials from your phone. See the “Using Personal Directory on Your Phone” section on page 42.

Using Your Personal Address Book on the Web

This section describes how to use your PAB from the User Options web pages.

If you want to...	Then do this after you log in...
Add a new PAB entry	<ol style="list-style-type: none">1. Choose User Options > Personal Address Book.2. Choose New.3. Enter information for the entry.4. Click Save.
Search for a PAB entry	<ol style="list-style-type: none">1. Choose User Options > Personal Address Book.2. Specify search information and click Find.
Edit a PAB entry	<ol style="list-style-type: none">1. Search for a PAB entry.2. Click a name or nickname.3. Edit the entry as needed and click Save.
Delete a PAB entry	<ol style="list-style-type: none">1. Search for a PAB entry.2. Select one or more entries.3. Click Delete Selected.

Configuring Fast Dials on the Web

This section describes how to assign Fast Dials from your User Options web pages.

If you want to...	Then do this after you log in...
Assign a Fast Dial code to a PAB entry	<ol style="list-style-type: none"> 1. Create a PAB entry. See the “Using Your Personal Address Book on the Web” section on page 46. 2. Choose User Options > Fast Dials. 3. Click Add New. 4. Change the Fast Dial code, if desired. 5. Use the Search Options area to find the appropriate PAB entry. 6. Click a phone number in the Search Results area. 7. Click Save.
Assign a Fast Dial code to a phone number (without using a PAB entry)	<ol style="list-style-type: none"> 1. Choose User Options > Fast Dials. 2. Click Add New. 3. Change the Fast Dial code, if desired. 4. Enter a phone number. 5. Click Save.
Search for a Fast Dial entry	<ol style="list-style-type: none"> 1. Choose User Options > Fast Dials. 2. Specify search information and click Find.
Edit a Fast Dial phone number	<ol style="list-style-type: none"> 1. Choose User Options > Fast Dials. 2. Search for the Fast Dial entry that you want to edit. 3. Click on a component of the entry. 4. Change the phone number. 5. Click Save.
Delete a Fast Dial entry	<ol style="list-style-type: none"> 1. Search for a Fast Dial. 2. Select one or more entries. 3. Click Delete Selected.

Tips

- You can create up to 500 Fast Dial and PAB entries.
- You can create a new Fast Dial entry without using a PAB entry. Such Fast Dial entries are labeled “raw” in the User Options pages and do not display a configurable text label.

Using the Address Book Synchronization Tool

You can use Cisco Unified CallManager Address Book Synchronizer to synchronize your existing Microsoft Windows Address Book (if applicable) with your PAB. Entries from your Microsoft Windows Address Book will then be accessible on your Cisco Unified IP Phone and User Options web pages. Your system administrator must make Cisco Unified CallManager Address Book Synchronizer available to you.

Setting Up Speed Dials on the Web

Depending on configuration, your phone can these speed-dial features:

- Speed-dial buttons
- Abbreviated Dialing
- Fast Dials



Note For help using speed-dial features, see the “Speed Dialing” section on page 30.

If you want to...	Then do this after you log in...
Set up speed-dial buttons	<ol style="list-style-type: none">1. Select a device.2. Click Speed Dials.3. Enter a number and label for a speed-dial button (programmable button) on your phone. Enter the number exactly as you would need to dial it from your desk phone. For example, enter an access code such as 9 or the area code, if necessary.4. Click Save. <p>Note Your phone uses the ASCII Label field if the phone does not support double-byte character sets.</p>
Set up Abbreviated Dialing	<ol style="list-style-type: none">1. Select a device.2. Click Speed Dials.3. Enter a number and label for an Abbreviated Dialing code.4. Click Save.
Set up Fast Dials	See the “Configuring Fast Dials on the Web” section on page 47. You can also set up Fast Dials on your phone. See the “Using Personal Directory on Your Phone” section on page 42.

Setting Up Phone Services on the Web

Before you can access phone services on your phone, you must subscribe to them using your User Options web pages. Phone services can include special phone features, network data, and web-based information (such as stock quotes and movie listings).

Your system administrator makes phone services available to you; you must then subscribe to an available service before using the service.

If you want to...	Then do this after you log in and select a device...
Subscribe to a service	<ol style="list-style-type: none"> 1. Select a device. 2. Click Phone Services. 3. Click Add New. 4. Choose a service from the drop-down list and click Next. 5. Change the service label and/or enter additional service information, if available (optional). 6. Click Save.
Search for services	<ol style="list-style-type: none"> 1. Select a device. 2. Click Phone Services. 3. Click Find.
Change or end services	<ol style="list-style-type: none"> 1. Search for services. 2. Select one or more entries. 3. Click Delete Selected.
Change a service name	<ol style="list-style-type: none"> 1. Search for services. 2. Click on the service name. 3. Change the information and click Save.
Access a service on your phone	<p>On your phone, press the Menu button and then select Services. A list of services that you have subscribed to or that your system administrator has assigned to you will be displayed.</p>

Controlling User Settings on the Web

User settings include your password, PIN, and locale (language) settings.

If you want to...	Then do this after you log in...
Change your password	<ol style="list-style-type: none">1. Choose User Options > User Settings.2. In the Browser Password area, enter information.3. Click Save.
Change your PIN	<ol style="list-style-type: none">1. Choose User Options > User Settings.2. In the Phone PIN area, enter information.3. Click Save.
Change the locale (language) for your User Options web pages	<ol style="list-style-type: none">1. Choose User Options > User Settings.2. In the User Locale area, choose an item from the Locale drop-down list.3. Click Save.
Change the locale (language) for your phone screen	<ol style="list-style-type: none">1. Go to the Device Configuration page by choosing User Options > Device.2. Choose an item from the User Locale drop-down list.3. Click Save.

Tip

Your PIN and password allow you to access different features and services. For example, use your PIN to log in to Personal Directory on your phone. Use your password to log in to your User Options web pages and Cisco WebDialer on your personal computer. For more information, ask your system administrator.

Using Cisco WebDialer

Cisco WebDialer allows you to make calls on your Cisco Unified IP Phone to directory contacts by clicking on items in a web browser. Your system administrator must configure this feature for you.

If you want to...	Then...
Use WebDialer with your User Options directory	<ol style="list-style-type: none"> 1. Log into your User Options web pages. See the “Accessing Your User Options Web Pages” section on page 45. 2. Choose User Options > Directory and search for a coworker. 3. Click the number that you want to dial. 4. If this is your first time using WebDialer, set up preferences and click Submit. (See the last entry in this table for details.) 5. If the Make Call page appears, click Dial. (See the last entry in this table to learn how to suppress this page in the future, if desired.) The call is now placed on your phone. 6. To end a call, click Hangup or hang up from your phone.
Use WebDialer with another online corporate directory (not your User Options directory)	<ol style="list-style-type: none"> 1. Log into a WebDialer-enabled corporate directory and search for coworkers. 2. Click the number that you want to dial. 3. When prompted, enter your user ID and password. 4. If this is your first time using WebDialer, set up preferences and click Submit. (See the last row in this table for details.) 5. If the Make Call page appears, click Dial. (See the last entry in this table to learn how to suppress this page in the future, if desired.) The call is now placed on your phone. 6. To end a call, click Hangup or hang up from your phone.

If you want to...	Then...
Log out of WebDialer	Click the logout icon in the Make Call or Hang Up page.
Set up, view, or change WebDialer preferences	<p data-bbox="341 237 663 261">Access the Preferences page.</p> <p data-bbox="341 277 1206 334">The Preferences page appears the first time that you use WebDialer (after you click the number that you want to dial.)</p> <p data-bbox="341 350 1174 407">To return to Preferences in the future, click the preferences icon from the Make Call or Hang Up page.</p> <p data-bbox="341 423 942 448">The Preferences page contains the following options:</p> <ul data-bbox="354 464 1206 915" style="list-style-type: none"> <li data-bbox="354 464 1139 521">• Preferred language—Determines the language used for WebDialer settings and prompts. <li data-bbox="354 537 1206 708">• Use permanent device—Identifies the Cisco Unified IP Phone and directory number (line) that you will use to place WebDialer calls. If you have one phone with a single line, the appropriate phone and line are automatically selected. Otherwise, choose a phone and/or line. Phones are specified by host name. (To display the host name on your phone, choose Menu > Settings > Network Configuration > Host Name.) <li data-bbox="354 724 1206 813">• Use Extension Mobility—If selected, prompts WebDialer to use the Cisco Unified IP Phone that is associated with your Extension Mobility profile (if available). <li data-bbox="354 829 1206 915">• Do not display call confirmation—If selected, prompts WebDialer to suppress the Make Call page. This page appears by default after you click a phone number in a WebDialer-enabled online directory.

Understanding Additional Configuration Options

Your system administrator can configure your phone to use specific button and softkey templates along with special services and features, if appropriate. The table below provides an overview of some configuration options that you might want to discuss with your phone system administrator based on your calling needs or work environment.

If you...	Then...	For more information...
Need to handle more calls on your phone line	Ask your system administrator to configure your line to support more calls. Your phone line can support a maximum of six calls.	Talk to your system administrator or phone support team.
Need more speed dial numbers	First make sure that you are using all of your currently available speed dial numbers. If you need additional speed dial numbers, consider subscribing to the Fast Dial service.	See the: <ul style="list-style-type: none"> • “Speed Dialing” section on page 30 • “Setting Up Phone Services on the Web” section on page 49
Want to use one extension for several phones	Request a shared line. This allows you to use one extension number for your desk phone and mobile phone, for example.	See the “Understanding Shared Lines” section on page 33.
Share phones or office space with co-workers	Consider using: <ul style="list-style-type: none"> • Call Park to store and retrieve calls without using the transfer feature • Call Pickup to answer calls ringing on another phone using your own phone • A shared line 	<ul style="list-style-type: none"> • Talk to your system administrator or phone help desk about getting these features. • See the “Advanced Call Handling” section on page 30 for instructions on using these features.
Log into your phone features from another phone in the system	Ask your system administrator to configure the Extension Mobility service for your phone.	See “Using Cisco Extension Mobility” section on page 37.

Troubleshooting Your Phone

This section tells you how to access information about your Cisco Unified IP Phone and phone calls to help your system administrator or technician diagnose problems with your phone. The information in this section is only necessary if your administrator asks you to perform one of the procedures.

If you are asked to...	Then...
Access network configuration data	Press the Menu button and select Settings > Network Configuration . Select the network configuration item to view. Press Cancel to exit this menu.
Access status data	Press the Menu button and select Settings > Status . Select the status item to view: Status Messages, Network Statistics, and Firmware Versions for your phone.
Access phone model information	Press the Menu button and select Settings > Model Information . Use the Navigation button to scroll through and view model information for your phone.



Note Your system administrator may disable your access to the **Settings** menu. Therefore, you might not be able to access network configuration data, status data, or model information.

Using the Quality Reporting Tool

Your system administrator may temporarily configure your Cisco Unified IP Phone with the Quality Reporting Tool to troubleshoot problems with your phone calls. With the Quality Reporting Tool, you can use the **QRT** softkey to submit information about problem phone calls to your system administrator. Depending on how your system administrator configured the Quality Reporting Tool for your phone, you can use the **QRT** softkey in one of two ways:

If you want to...	Then...
Quickly report an audio problem with a current call	While on a call, press more > QRT . Your phone system will collect and log audio data for the current call and route this information to your system administrator.
Report a problem with your phone calls	Press more > QRT . Select the problem you want to report from the list of problem categories. Some problem categories include a reason code you can select to provide more details about the problem. Your phone system will route this information to your system administrator so he/she can diagnose the problem.

Cisco One-Year Limited Hardware Warranty Terms

There are special terms applicable to your hardware warranty and various services that you can use during the warranty period. Your formal Warranty Statement, including the warranties and license agreements applicable to Cisco software, is available on Cisco.com. Follow these steps to access and download the *Cisco Information Packet* and your warranty and license agreements from Cisco.com.

1. Launch your browser, and go to this URL:
http://www.cisco.com/univercd/cc/td/doc/es_inpk/cetrans.htm
The Warranties and License Agreements page appears.
2. To read the *Cisco Information Packet*, follow these steps:
 - a. Click the **Information Packet Number** field, and make sure that the part number 78-5235-03A0 is highlighted.
 - b. Select the language in which you would like to read the document.
 - c. Click **Go**.
 - d. The Cisco Limited Warranty and Software License page from the Information Packet appears.
 - e. Read the document online, or click the **PDF** icon to download and print the document in Adobe Portable Document Format (PDF).

**Note**

You must have Adobe Acrobat Reader to view and print PDF files. You can download the reader from Adobe's website: <http://www.adobe.com>

3. To read translated and localized warranty information about your product, follow these steps:
 - a. Enter this part number in the Warranty Document Number field:
78-10747-01C0
 - b. Select the language in which you would like to view the document.
 - c. Click **Go**.
The Cisco warranty page appears.
 - d. Read the document online, or click the **PDF** icon to download and print the document in Adobe Portable Document Format (PDF).

You can also contact the Cisco service and support website for assistance:

http://www.cisco.com/public/Support_root.shtml

Duration of Hardware Warranty

One (1) Year

Replacement, Repair, or Refund Policy for Hardware

Cisco or its service center will use commercially reasonable efforts to ship a replacement part within ten (10) working days after receipt of a Return Materials Authorization (RMA) request. Actual delivery times can vary, depending on the customer location.

Cisco reserves the right to refund the purchase price as its exclusive warranty remedy.

To Receive a Return Materials Authorization (RMA) Number

Contact the company from whom you purchased the product. If you purchased the product directly from Cisco, contact your Cisco Sales and Service Representative.

Complete the information below, and keep it for reference.

Company product purchased from	
Company telephone number	
Product model number	
Product serial number	
Maintenance contract number	



Corporate Headquarters

Cisco Systems, Inc.
170 West Tasman Drive
San Jose, CA 95134-1706
USA

www.cisco.com
Tel: 408 526-4000
800 553-NETS (6387)
Fax: 408 526-4100

European Headquarters

Cisco Systems International BV
Haarlerbergpark
Haarlerbergweg 13-19
1101 CH Amsterdam
The Netherlands

www-europe.cisco.com
Tel: 31 0 20 357 1000
Fax: 31 0 20 357 1100

Americas Headquarters

Cisco Systems, Inc.
170 West Tasman Drive
San Jose, CA 95134-1706
USA

www.cisco.com
Tel: 408 526-7660
Fax: 408 527-0883

Asia Pacific Headquarters

Cisco Systems, Inc.
168 Robinson Road
#28-01 Capital Tower
Singapore 068912

www.cisco.com
Tel: +65 6317 7777
Fax: +65 6317 7799

Cisco Systems has more than 200 offices in the following countries. Addresses, phone numbers, and fax numbers are listed on the

Cisco Website at www.cisco.com/go/offices

Argentina • Australia • Austria • Belgium • Brazil • Bulgaria • Canada • Chile • China PRC • Colombia • Costa Rica • Croatia • Cyprus • Czech Republic • Denmark • Dubai, UAE
Finland • France • Germany • Greece • Hong Kong SAR • Hungary • India • Indonesia • Ireland • Israel • Italy • Japan • Korea • Luxembourg • Malaysia • Mexico
The Netherlands • New Zealand • Norway • Peru • Philippines • Poland • Portugal • Puerto Rico • Romania • Russia • Saudi Arabia • Scotland • Singapore
Slovakia • Slovenia • South Africa • Spain • Sweden • Switzerland • Taiwan • Thailand • Turkey • Ukraine • United Kingdom • United States • Venezuela • Vietnam • Zimbabwe

CCSP, CCVP, the Cisco Square Bridge logo, Follow Me Browsing, and StackWise are trademarks of Cisco Systems, Inc.; Changing the Way We Work, Live, Play, and Learn, and iQuick Study are service marks of Cisco Systems, Inc.; and Access Registrar, Aironet, BPX, Catalyst, CCDA, CCDP, CCIE, CCIIP, CCNA, CCNP, Cisco, the Cisco Certified Internetwork Expert logo, Cisco IOS, Cisco Press, Cisco Systems, Cisco Systems Capital, the Cisco Systems logo, Cisco Unity, Enterprise/Solver, EtherChannel, EtherFast, EtherSwitch, Fast Step, FormShare, GigaDrive, GigaStack, HomeLink, Internet Quotient, IOS, IP/TV, iQ Expertise, the iQ logo, iQ Net Readiness Scorecard, LightStream, Linksys, MeetingPlace, MGX, the Networkers logo, Networking Academy, Network Registrar, *Packet*, PIX, Post-Routing, Pre-Routing, ProConnect, RateMUX, ScriptShare, SlideCast, SMARTnet, The Fastest Way to Increase Your Internet Quotient, and TransPath are registered trademarks of Cisco Systems, Inc. and/or its affiliates in the United States and certain other countries.

All other trademarks mentioned in this document or Website are the property of their respective owners. The use of the word partner does not imply a partnership relationship between Cisco and any other company. (0601R)

© 2006 Cisco Systems, Inc. All rights reserved.

OL-8166-01