



# Cisco UCS C220 M5 Rack Server (Small Form Factor Disk Drive Model)

# CONTENTS

<b>OVERVIEW</b>	<b>3</b>
<b>DETAILED VIEWS</b>	<b>4</b>
Chassis Front View	4
Chassis Rear View	5
<b>BASE SERVER STANDARD CAPABILITIES and FEATURES</b>	<b>6</b>
<b>CONFIGURING the SERVER</b>	<b>10</b>
STEP 1 VERIFY SERVER SKU	11
STEP 2 SELECT CPU(s)	12
STEP 3 SELECT MEMORY	15
STEP 4 SELECT RAID CONTROLLERS	18
RAID Controller Options (internal HDD/SSD support)	18
Embedded Software RAID	18
Cisco 12G SAS RAID Controller	18
SAS HBA (internal HDD/SSD/JBOD support)	18
RAID Volumes and Groups	18
STEP 5 SELECT DRIVES	22
STEP 6 SELECT PCIe OPTION CARD(s)	25
STEP 7 ORDER POWER SUPPLY	28
STEP 8 SELECT POWER CORD(s)	29
STEP 9 ORDER TOOL-LESS RAIL KIT AND OPTIONAL REVERSIBLE CABLE MANAGEMENT ARM	32
STEP 10 SELECT MANAGEMENT CONFIGURATION (OPTIONAL)	33
STEP 11 SELECT SERVER BOOT MODE (OPTIONAL)	34
STEP 12 ORDER SECURITY DEVICES (OPTIONAL)	35
STEP 13 SELECT LOCKING SECURITY BEZEL (OPTIONAL)	36
STEP 14 ORDER CISCO SD CARD MODULE (OPTIONAL)	37
STEP 15 ORDER M.2 SATA SSD (OPTIONAL)	38
STEP 16 ORDER INTERNAL MICRO-SD CARD MODULE (OPTIONAL)	39
STEP 17 ORDER OPTIONAL USB 3.0 DRIVE	40
STEP 18 SELECT OPERATING SYSTEM AND VALUE-ADDED SOFTWARE	41
STEP 19 SELECT OPERATING SYSTEM MEDIA KIT	47
STEP 20 SELECT SERVICE and SUPPORT LEVEL	48
<b>OPTIONAL STEP - ORDER RACK(s)</b>	<b>54</b>
<b>OPTIONAL STEP - ORDER PDU</b>	<b>55</b>
<b>SUPPLEMENTAL MATERIAL</b>	<b>56</b>
CHASSIS	56
Block Diagram	58
RAID Option ROM (OPROM) Settings	59
Serial Port Details	62
Upgrade and Servicing-Related Parts	63
RACKS	64
PDUs	65
KVM CABLE	66
<b>TECHNICAL SPECIFICATIONS</b>	<b>67</b>
Dimensions and Weight	67
Power Specifications	68
Environmental Specifications	71
Extended Operating Temperature Hardware Configuration Limits	72
Compliance Requirements	73



## OVERVIEW

The UCS C220 M5 SFF server extends the capabilities of Cisco's Unified Computing System portfolio in a 1U form factor with the addition of the Intel® Xeon® Processor Scalable Family, 24 DIMM slots for 2666MHz DIMMs and capacity points up to 128GB, two 2 PCI Express (PCIe) 3.0 slots, and up to 10 SAS/SATA hard disk drives (HDDs) or solid state drives (SSDs). The C220 M5 SFF server also includes one dedicated internal slot for a 12G SAS storage controller card.

The C220 M5 server included one dedicated internal modular LAN on motherboard (mLOM) slot for installation of a Cisco Virtual Interface Card (VIC) or third-party network interface card (NIC), without consuming a PCI slot, in addition to 2 x 10Gbase-T Intel x550 embedded (on the motherboard) LOM ports.

The Cisco UCS C220 M5 server can be used standalone, or as part of the Cisco Unified Computing System, which unifies computing, networking, management, virtualization, and storage access into a single integrated architecture enabling end-to-end server visibility, management, and control in both bare metal and virtualized environments.

Figure 1 Cisco UCS C220 M5 SFF Rack Server

### Front View



### Rear View



# DETAILED VIEWS

## Chassis Front View

Figure 2 shows the front view of the Cisco UCS C220 M5 SFF Rack Server.

Figure 2 Chassis Front View

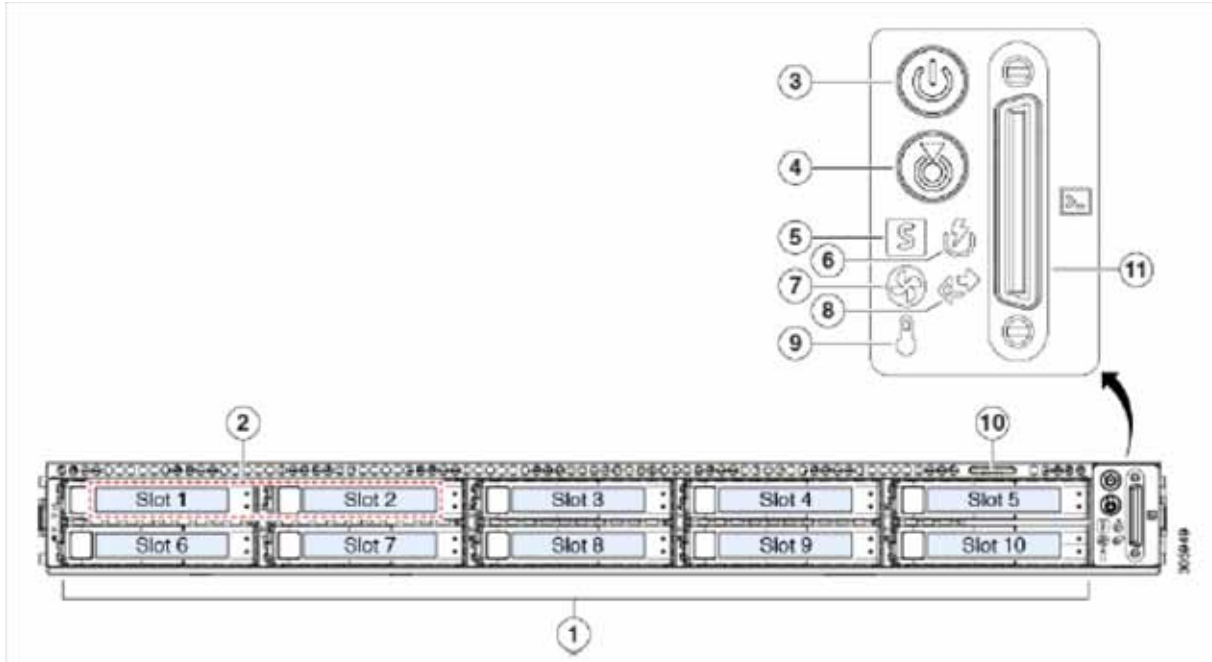

1	Drive bays 1 - 10 support SAS/SATA hard drives and solid state drives (SSDs).	7	Fan status LED
2	UCSC-C220-M5SX version: Drive bays 1 and 2 support SFF NVMe PCIe SSDs. UCSC-C220-M5SN <sup>1</sup> version: Drive bays 1 - 10 support SFF NVMe PCIe SSDs	8	Network link activity LED
3	Power button/Power status LED	9	Temperature status LED
4	Unit identification button/LED	10	Pull-out asset tag
5	System status LED	11	KVM connector (used with KVM cable that provides two USB 2.0, one VGA, and one serial connector)
6	Power supply status LED		

Notes:

- 1. Available at the end of CY 2017

## Chassis Rear View

Figure 3 shows the external features of the rear panel.

Figure 3 Chassis Rear View

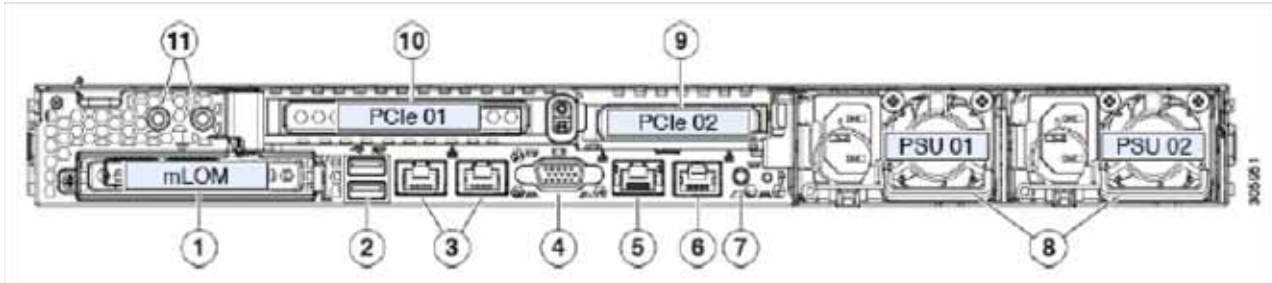

1	Modular LAN-on-motherboard (mLOM) card bay (x16)	7	Rear unit identification button/LED
2	USB 3.0 ports (two)	8	Power supplies (two, redundant as 1+1)
3	Dual 10-Gb Ethernet ports (LAN1 and LAN2). LAN1 is left connector and LAN2 is right connector	9	PCIe riser 2 (slot 2) (half-height, x16); includes PCIe cable connectors for 2 SFF NVMe SSDs (x8)
4	VGA video port (DB-15)	10	PCIe riser 1 (slot 1) (full-height, x16)
5	1-Gb Ethernet dedicated management port	11	Threaded holes for dual-hole grounding lug
6	Serial port (RJ-45 connector)		

## BASE SERVER STANDARD CAPABILITIES and FEATURES

*Table 1* lists the capabilities and features of the base server. Details about how to configure the server for a particular feature or capability (for example, number of processors, disk drives, or amount of memory) are provided in *CONFIGURING the SERVER, page 10*.

Table 1 Capabilities and Features

Capability/Feature	Description
Chassis	One rack unit (1RU) chassis
CPU	One or two Intel® Xeon® processor scalable family CPUs
Chipset	Intel® C620 series chipset
Memory	24 slots for registered DIMMs (RDIMMs) or load-reduced DIMMs (LRDIMMs), or through silicon via (TSV) DIMMs
Multi-bit Error Protection	This server supports multi-bit error protection.
Video	The Cisco Integrated Management Controller (CIMC) provides video using the ASPEED Pilot 4 video/graphics controller: <ul style="list-style-type: none"> <li>■ Integrated 2D graphics core with hardware acceleration</li> <li>■ DDR4 memory interface supports up to 16 MB directly accessible from host and entire DDR memory indirectly accessible from host processor.</li> <li>■ Supports all display resolutions up to 1920 x 1200 x 32bpp resolution at 60Hz</li> <li>■ High speed Integrated 24-bit RAMDAC</li> <li>■ Single lane PCI-Express host interface</li> <li>■ eSPI processor to BMC support</li> </ul>
SATA Interposer Board	An optional SATA interposer board for up to eight SATA-only drives.
Power subsystem	Up to two of the following hot-swappable power supplies: <ul style="list-style-type: none"> <li>■ 770 W (AC)</li> <li>■ 1050 W (AC)</li> <li>■ 1050 W (DC)</li> </ul> One power supply is mandatory; one more can be added for 1 + 1 redundancy.
WoL	The Intel x550 10G Base-T Ethernet LAN ports support the wake-on-LAN (WoL) standard.
Front Panel	A front panel controller provides status indications and control buttons
ACPI	This server supports the advanced configuration and power interface (ACPI) 4.0 standard.
Fans	<ul style="list-style-type: none"> <li>■ Seven hot-swappable fans for front-to-rear cooling</li> </ul>

Table 1 Capabilities and Features (*continued*)

Capability/Feature	Description
Infiniband	The InfiniBand architecture is supported by the PCI slots.
Expansion slots	<ul style="list-style-type: none"> <li>■ Riser 1 (controlled by CPU 1):           <ul style="list-style-type: none"> <li>• One full-height profile, 3/4-length slot with x24 connector and x16 lane.</li> </ul> </li> <li>■ Riser 2 (controlled by CPU 2):           <ul style="list-style-type: none"> <li>• One half-height profile, half-length slot with x24 connector and x16 lane.</li> </ul> </li> <li>■ Dedicated RAID controller slot (see <a href="#">Figure 5 on page 56</a>)           <ul style="list-style-type: none"> <li>• An internal slot is reserved for use by the Cisco 12G SAS RAID controller or the Cisco 12G SAS HBA.</li> </ul> </li> </ul>
Interfaces	<ul style="list-style-type: none"> <li>■ Rear panel           <ul style="list-style-type: none"> <li>• One 1-Gbps RJ-45 management port (Marvell 88E6176)</li> <li>• Two 10GBase-T LOM ports (Intel X550 controller embedded on the motherboard)</li> <li>• One RS-232 serial port (RJ45 connector)</li> <li>• One DB15 VGA connector</li> <li>• Two USB 3.0 port connectors</li> <li>• One flexible modular LAN on motherboard (mLOM) slot that can accommodate various interface cards</li> </ul> </li> <li>■ Front panel           <ul style="list-style-type: none"> <li>• One KVM console connector (supplies two USB 2.0 connectors, one VGA DB15 video connector, and one serial port (RS232) RJ45 connector)</li> </ul> </li> </ul>



Table 1 Capabilities and Features *(continued)*

Capability/Feature	Description
Internal storage devices	<p>Drives are installed into front-panel drive bays that provide hot-swappable access for SAS/SATA drives. The server is orderable in two different versions:</p> <ul style="list-style-type: none"> <li>■ UCSC-C220-M5SX:                             <ul style="list-style-type: none"> <li>• Up to 10 SFF SAS/SATA hard drives (HDDs) or SAS/SATA solid state drives (SSDs).</li> <li>• Optionally, up to two SFF NVMe PCIe SSDs (replacing SAS/SATA drives). These drives must be placed in front drive bays 1 and 2 only and are connected from Riser 2.</li> </ul> </li> <li>■ UCSC-C220-M5SN<sup>1</sup>:                             <ul style="list-style-type: none"> <li>• Up to 10 SFF NVMe PCIe SSDs. The drives in slots 1 and 2 are connected from Riser 2 and the drives in slots 3 through 10 are connected from the PCIe switch card plugged into the internal HBA slot.</li> </ul> </li> <li>■ One internal USB 3.0 port on the motherboard that you can use with an optional 16 GB USB thumb drive for additional storage.</li> <li>■ A mini-storage module connector on the motherboard supports either:                             <ul style="list-style-type: none"> <li>• An SD card module with two SD card slots. Mixing different capacity SD cards is not supported.</li> <li>• An M.2 module with two SATA M.2 SSD slots. Mixing different capacity M.2 modules is not supported.</li> </ul> </li> <li>■ One socket for a micro-SD card on PCIe Riser 1. The micro-SD card serves as a dedicated local resource for utilities such as HUU. Images can be pulled from a file share (NFS/CIFS) and uploaded to the cards for future use.</li> </ul>
Integrated management processor	<p>Baseboard Management Controller (BMC) running Cisco Integrated Management Controller (CIMC) firmware.</p> <p>Depending on your CIMC settings, the CIMC can be accessed through the 1-GbE dedicated management port, the 1-GbE LOM ports, or a Cisco virtual interface card (VIC).</p> <p>CIMC manages certain components within the server, such as the Cisco 12G SAS HBA.</p>

Table 1 Capabilities and Features *(continued)*

Capability/Feature	Description
Storage controller	<ul style="list-style-type: none"> <li>■ Embedded RAID (software RAID)                             <ul style="list-style-type: none"> <li>• Supports up to eight SATA-only drives</li> <li>• Requires a SATA interposer board</li> </ul> </li> <li>■ Cisco 12G SAS RAID controller card with internal SAS connectivity.                             <ul style="list-style-type: none"> <li>• Supports up to 10 internal SAS/SATA drives</li> <li>• Plugs into a dedicated RAID controller slot</li> <li>• Supports RAID 0, 1, 5, 6, 10, 50, 60 and JBOD mode</li> </ul> </li> <li>■ Cisco 12G SAS HBA (JBOD/Pass-through Mode)                             <ul style="list-style-type: none"> <li>• Supports up to 10 SAS/SATA internal drives</li> <li>• Plugs into the dedicated RAID controller slot</li> </ul> </li> </ul>
Modular LAN on Motherboard (mLOM) slot	<p>The dedicated mLOM slot on the motherboard can flexibly accommodate the following cards:</p> <ul style="list-style-type: none"> <li>■ Cisco Virtual Interface Cards</li> <li>■ Quad Port Intel i350 1GbE RJ45 Network Interface Card (NIC)</li> </ul> <hr/> <div style="display: flex; align-items: center;">  <p><b>NOTE:</b> The four Intel i350 ports are provided on an optional card that plugs into the mLOM slot, and are separate from the two embedded (on the motherboard) LAN ports</p> </div> <hr/>
UCSM	Unified Computing System Manager (UCSM) runs in the Fabric Interconnect and automatically discovers and provisions some of the server components.

Notes:

1. Available at the end of CY 2017

## CONFIGURING the SERVER

Follow these steps to configure the Cisco UCS C220 M5 SFF Rack Server:

- *STEP 1 VERIFY SERVER SKU, page 11*
- *STEP 2 SELECT CPU(s), page 12*
- *STEP 3 SELECT MEMORY, page 15*
- *STEP 4 SELECT RAID CONTROLLERS, page 18*
- *STEP 5 SELECT DRIVES, page 22*
- *STEP 6 SELECT PCIe OPTION CARD(s), page 25*
- *STEP 7 ORDER POWER SUPPLY, page 28*
- *STEP 8 SELECT POWER CORD(s), page 29*
- *STEP 9 ORDER TOOL-LESS RAIL KIT AND OPTIONAL REVERSIBLE CABLE MANAGEMENT ARM, page 32*
- *STEP 10 SELECT MANAGEMENT CONFIGURATION (OPTIONAL), page 33*
- *STEP 11 SELECT SERVER BOOT MODE (OPTIONAL), page 34*
- *STEP 12 ORDER SECURITY DEVICES (OPTIONAL), page 35*
- *STEP 13 SELECT LOCKING SECURITY BEZEL (OPTIONAL), page 36*
- *STEP 14 ORDER CISCO SD CARD MODULE (OPTIONAL), page 37*
- *STEP 15 ORDER M.2 SATA SSD (OPTIONAL), page 38*
- *STEP 16 ORDER INTERNAL MICRO-SD CARD MODULE (OPTIONAL), page 39*
- *STEP 17 ORDER OPTIONAL USB 3.0 DRIVE, page 40*
- *STEP 18 SELECT OPERATING SYSTEM AND VALUE-ADDED SOFTWARE, page 41*
- *STEP 19 SELECT OPERATING SYSTEM MEDIA KIT, page 47*
- *STEP 20 SELECT SERVICE and SUPPORT LEVEL, page 48*
- *OPTIONAL STEP - ORDER RACK(s), page 54*
- *OPTIONAL STEP - ORDER PDU, page 55*

## STEP 1 VERIFY SERVER SKU

Verify the product ID (PID) of the server as shown in [Table 2](#).

Table 2 PID of the C220 M5 SFF Rack Base Server

Product ID (PID)	Description
UCSC-C220-M5SX	UCS C220 M5 10 SFF front drives with no CPU, memory, HDD, PCIe cards, or power supply
UCSC-C220-M5SN	UCS C220 M5 10 SFF front drives (NVMe only) with no CPU, memory, HDD, PCIe cards, or power supply

The Cisco UCS C220 M5 SFF server:

- Does not include power supply, CPU, memory, hard disk drives (HDDs), solid-state drives (SSDs), SD cards, tool-less rail kit, or plug-in PCIe cards.



**NOTE:** Use the steps on the following pages to configure the server with the components that you want to include.

## STEP 2 SELECT CPU(s)

The standard CPU features are:

- Intel® Xeon® processor scalable family CPUs
- Intel C620 series chipset
- Cache size of up to 38.5 MB

### Select CPUs

The available CPUs are listed in [Table 3](#).

Table 3 Available Intel CPUs (Sheet 1 of 2)

Product ID (PID)	Intel <sup>1</sup> Number	Clock Freq (GHz)	Power (W)	Cache Size (MB)	Cores	UPI <sup>2</sup> Links (GT/s)	Highest DDR4 DIMM Clock Support (MHz) <sup>3</sup>
<b>Intel® Xeon® Processor Scalable Family CPUs</b>							
UCS-CPU-8180M	8180M	2.5	205	38.50	28	3 x 10.4	2666
UCS-CPU-6142M	6142M	2.6	150	22.00	16	3 x 10.4	2666
UCS-CPU-6134M	6134M	3.2	130	24.75	8	3 x 10.4	2666
UCS-CPU-8176M	8176M	2.1	165	38.50	28	3 x 10.4	2666
UCS-CPU-8170M	8170M	2.1	165	35.75	26	3 x 10.4	2666
UCS-CPU-8160M	8160M	2.1	150	33.00	24	3 x 10.4	2666
UCS-CPU-6140M	6140M	2.3	140	24.75	18	3 x 10.4	2666
UCS-CPU-8180	8180	2.5	205	38.50	28	3 x 10.4	2666
UCS-CPU-8176	8176	2.1	165	38.50	28	3 x 10.4	2666
UCS-CPU-8170	8170	2.1	165	35.75	26	3 x 10.4	2666
UCS-CPU-8168	8168	2.7	205	33.00	24	3 x 10.4	2666
UCS-CPU-8164	8164	2.0	150	35.75	26	3 x 10.4	2666
UCS-CPU-8160	8160	2.1	150	33.00	24	3 x 10.4	2666
UCS-CPU-8158	8158	3.0	150	24.75	12	3 x 10.4	2666
UCS-CPU-8156	8156	3.6	105	16.50	4	3 x 10.4	2666
UCS-CPU-8153	8153	2.0	125	22.00	16	3 x 10.4	2666
UCS-CPU-6154	6154	3.0	200	24.75	18	3 x 10.4	2666
UCS-CPU-6152	6152	2.1	140	30.25	22	3 x 10.4	2666
UCS-CPU-6150	6150	2.7	165	24.75	18	3 x 10.4	2666
UCS-CPU-6148	6148	2.4	150	27.50	20	3 x 10.4	2666
UCS-CPU-6142	6142	2.6	150	22.00	16	3 x 10.4	2666
UCS-CPU-6140	6140	2.3	140	24.75	18	3 x 10.4	2666
UCS-CPU-6138	6138	2.0	125	27.50	20	3 x 10.4	2666
UCS-CPU-6136	6136	3.0	150	24.75	12	3 x 10.4	2666

Table 3 Available Intel CPUs (*continued*) (Sheet 2 of 2)

Product ID (PID)	Intel <sup>1</sup> Number	Clock Freq (GHz)	Power (W)	Cache Size (MB)	Cores	UPI <sup>2</sup> Links (GT/s)	Highest DDR4 DIMM Clock Support (MHz) <sup>3</sup>
UCS-CPU-6134	6134	3.2	130	24.75	8	3 X 10.4	2666
UCS-CPU-6132	6132	2.6	140	19.25	14	3 x 10.4	2666
UCS-CPU-6130	6130	2.1	125	22.00	16	3 x 10.4	2666
UCS-CPU-6128	6128	3.4	115	19.25	6	3 x 10.4	2666
UCS-CPU-6126	6126	2.6	125	19.25	12	3 x 10.4	2666
UCS-CPU-5122	5122	3.6	105	16.50	4	2 x 10.4	2666
UCS-CPU-5120	5120	2.2	105	19.25	14	2 x 10.4	2400
UCS-CPU-5118	5118	2.3	105	16.50	12	2 x 10.4	2400
UCS-CPU-5115	5115	2.4	85	13.75	10	2 x 10.4	2400
UCS-CPU-4116	4116	2.1	85	16.50	12	2 x 9.6	2400
UCS-CPU-4114	4114	2.2	85	13.75	10	2 x 9.6	2400
UCS-CPU-4112	4112	2.6	85	8.25	4	2 x 9.6	2400
UCS-CPU-4110	4110	2.1	85	11.00	8	2 x 9.6	2400
UCS-CPU-4108	4108	1.8	85	11.00	8	2 x 9.6	2400
UCS-CPU-3106	3106	1.7	85	11.00	8	2 x 9.6	2133
UCS-CPU-3104	3104	1.7	85	8.25	6	2 x 9.6	2133

## Notes:

1. Only CPU PIDs ending in "M" support 1.5 TB/socket of memory, per Intel CPU spec. All other CPU PIDs support 768 GB/socket memory.
2. UPI = Ultra Path Interconnect. 2-socket servers support only 2 UPI performance, even if the CPU supports 3 UPI.
3. If higher or lower speed DIMMs are selected than what is shown in the table for a given CPU, the DIMMs will be clocked at the lowest common denominator of CPU clock and DIMM clock.

## Approved Configurations

---

(1) 1-CPU configurations:

- Select any one CPU listed in [Table 3 on page 12](#).

(2) 2-CPU Configurations:

- Select two identical CPUs from any one of the rows of [Table 3 on page 12](#).

## Caveats

---

- You can select either one processor or two identical processors.
- The selection of 1 or 2 CPUs depends on the desired server functionality. See the following sections:
  - [STEP 3 SELECT MEMORY, page 15](#) (memory mirroring section)
  - [Table 6 on page 21](#) (RAID support table)
  - [STEP 5 SELECT DRIVES, page 22](#)
  - [STEP 4 SELECT RAID CONTROLLERS, page 18](#)
  - [STEP 6 SELECT PCIe OPTION CARD\(s\), page 25](#)

## STEP 3 SELECT MEMORY

The standard memory features are:

- DIMMs
  - Clock speed: 2666 MHz
  - Ranks per DIMM: 1, 2, 4, or 8
  - Operational voltage: 1.2 V
  - Registered ECC DDR4 DIMMs (RDIMMs) load-reduced DIMMs (LRDIMMs), or through silicon via (TSV) DIMMs
- Memory is organized with six memory channels per CPU, with up to two DIMMs per channel, as shown in [Figure 4](#).

Figure 4 C220 M5 SFF Memory Organization

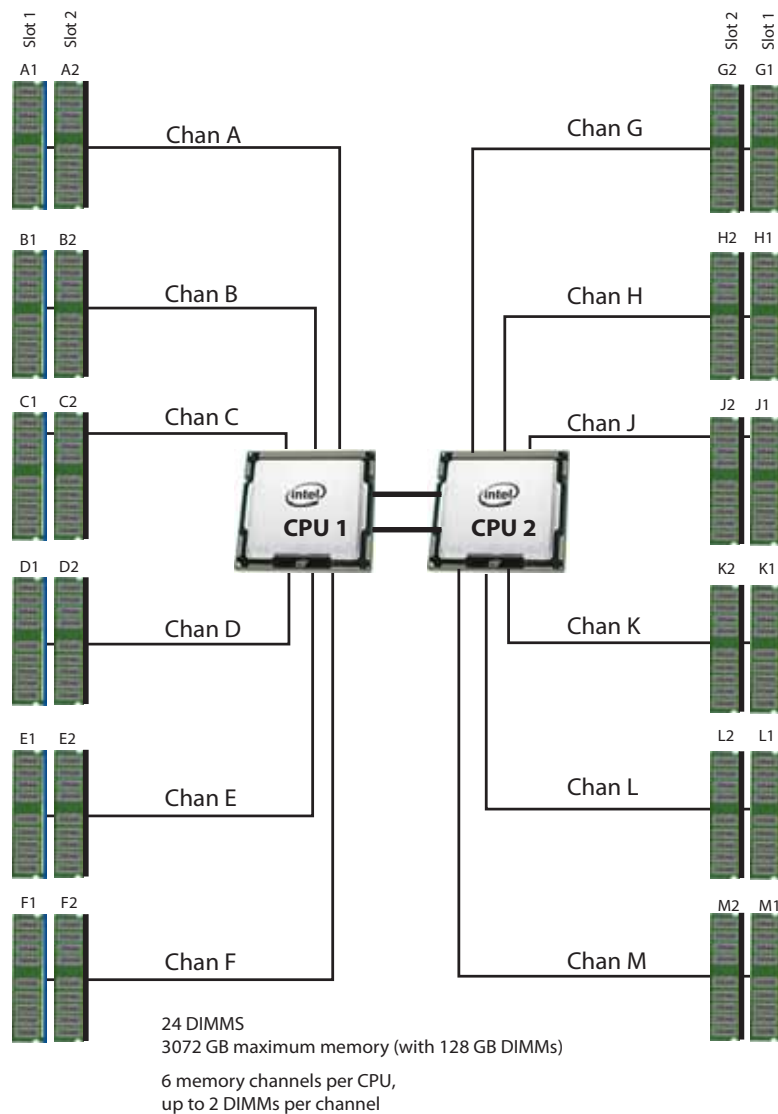



Select DIMMs and Memory Mirroring

Select the memory configuration and whether or not you want the memory mirroring option. The available memory DIMMs and mirroring option are listed in [Table 4](#).



**NOTE:** When memory mirroring is enabled, the memory subsystem simultaneously writes identical data to two channels. If a memory read from one of the channels returns incorrect data due to an uncorrectable memory error, the system automatically retrieves the data from the other channel. A transient or soft error in one channel does not affect the mirrored data, and operation continues unless there is a simultaneous error in exactly the same location on a DIMM and its mirrored DIMM. Memory mirroring reduces the amount of memory available to the operating system by 50% because only one of the two populated channels provides data.

Table 4 Available DDR4 DIMMs

Product ID (PID)	PID Description	Voltage	Ranks /DIMM
UCS-MR-128G8RS-H	128 GB DDR4-2666-MHz TSV-RDIMM/PC4-21300/8R/x4	1.2 V	8
UCS-MR-X64G4RS-H	64 GB DDR4-2666-MHz TSV-RDIMM/PC4-21300/4R/x4	1.2 V	4
UCS-ML-X64G4RS-H	64 GB DDR4-2666-MHz LRDIMM/PC4-21300/4R/x4	1.2 V	4
UCS-MR-X32G2RS-H	32 GB DDR4-2666-MHz RDIMM/PC4-21300/2R/x4	1.2 V	2
UCS-MR-X16G1RS-H	16 GB DDR4-2666-MHz RDIMM/PC4-21300/1R/x4	1.2 V	1
UCS-MR-X16G2RS-H	16 GB DDR4-2666-MHz RDIMM/PC4-21300/2R/x4	1.2 V	2
UCS-MR-X8G1RS-H	8 GB DDR4-2666-MHz RDIMM/PC4-21300/1R/x4	1.2 V	1
<b>Memory Mirroring Option</b>			
N01-MMIRROR	Memory mirroring option		

Approved Configurations

(1) 1-CPU configuration without memory mirroring:

- Select from 1 to 12 DIMMs.

(2) 1-CPU configuration with memory mirroring:

- Select 4, 6, 8, or 12 identical DIMMs. The DIMMs will be placed by the factory as shown in the following table.

CPU 1 DIMM Placement in Channels (for identical ranked DIMMs)	
4	(A1, B1); (D1, E1)
6	(A1, B1, C1); (D1, E1, F1)
8	(A1, A2, B1, B2); (D1, D2, E1, E2)
12	(A1, A2, B1, B2, C1, C2); (D1, D2, E1, E2, F1, F2)

- Select the memory mirroring option (N01-MMIRROR) as shown in [Table 4 on page 16](#).

(3) 2-CPU configuration without memory mirroring:

- Select from 1 to 12 DIMMs per CPU.

(4) 2-CPU configuration with memory mirroring:

- Select 8, 12, 16, or 24 identical DIMMs per CPU. The DIMMs will be placed by the factory as shown in the following table.

	CPU 1 DIMM Placement in Channels (for identical ranked DIMMs) CPU 1	CPU 2 DIMM Placement in Channels (for identical ranked DIMMs) CPU 2
8	(A1,B1); (D1,E1)	(G1, H1); (K1, L1)
12	(A1, B1, C1); (D1, E1, F1)	(G1, H1, J1); (K1, L1, M1)
16	(A1, A2, B1, B2); (D1, D2, E1, E2)	(G1, G2, H1, H2); (K1, K2, L1, L2)
24	(A1, A2, B1, B2, C1, C2); (D1, D2, E1, E2, F1, F2)	(G1, G2, H1, H2, J1, J2); (K1, K2, L1, L2, M1, M2)

- Select the memory mirroring option (N01-MMIRROR) as shown in [Table 4 on page 16](#).



**NOTE:** System performance is optimized when the DIMM type and quantity are equal for both CPUs, and when all channels are filled equally across the CPUs in the server.

## STEP 4 SELECT RAID CONTROLLERS

### RAID Controller Options (internal HDD/SSD support)

#### Embedded Software RAID

The default RAID configuration is embedded software RAID, which supports only SATA HDDs and enterprise value SSDs (RAID 0, 1, 10). A maximum of 8 SATA drives are supported with embedded software RAID. Embedded RAID requires a SATA interposer board.



**NOTE:** The embedded software RAID is limited to Windows and Linux operating systems only. There is no VMWare support for operating systems only. There is no VMWare support for embedded software RAID.

#### Cisco 12G SAS RAID Controller

You can choose a Cisco 12G SAS RAID controller, which plugs into a dedicated RAID controller card slot. This RAID controller includes a 2 GB cache and supports RAID 0, 1, 5, 6, 10, 50, 60 and JBOD mode.



**NOTE:** The number of RAID groups (virtual drives) supported per RAID controller is as follows:

- Embedded RAID = 8
- Cisco 12G SAS RAID controller = 64

#### SAS HBA (internal HDD/SSD/JBOD support)

You can choose a SAS HBA for JBOD or Pass-through mode support:

- The Cisco 12G SAS HBA plugs into a dedicated RAID controller slot.

#### RAID Volumes and Groups

When creating each RAID volume, follow these guidelines:

- Use the same capacity for each drive in each RAID volume
- For embedded software RAID:
  - Use only SATA HDDs
  - Embedded software RAID has two ports and each port can control 4 drives, for 8 drives total.
  - Each set of 4 SATA HDDs for a port must be in separate RAID volumes.
  - You cannot mix drives across ports to create a RAID volume.
  - For more details, see [Embedded Software RAID, page 18](#).
- For the Cisco 12G SAS RAID controller upgrade:
  - Use either all SAS HDDs, or all SAS SSDs, or all SATA SSDs in each RAID volume

## Select Controller Options

Select one of the following:

- Embedded software RAID (this is the default if no other selection is made), or
- One Cisco 12G SAS RAID controller or Cisco 12G SAS HBA (see [Table 5 on page 19](#))



NOTE: The UCSC-C220-M5SN does not support embedded RAID.

For the Cisco 12G SAS RAID controller, select an appropriate optional RAID configuration listed in [Table 5 on page 19](#)

[Table 5](#) shows the product ID for the C220 M5 server entry-level RAID solution. This RAID option is accomplished with embedded software that supports a limited number of drives, operating systems, and virtualized environments. For a more comprehensive enterprise RAID solution, choose the Cisco 12G SAS RAID controller listed in [Table 5](#).

Table 5 Hardware Controller Options

Product ID (PID)	PID Description
<b>Controllers for Internal Drives</b>	
Note that if the following Cisco 12G SAS RAID controller or Cisco 12G SAS HBA controller is selected, it is factory-installed in the dedicated internal slot.	
UCSC-RAID-M5	Cisco 12G SAS RAID Controller with 2GB FBWC <ul style="list-style-type: none"> <li>■ Supports up to 10 internal SAS HDDs and SAS/SATA SSDs</li> <li>■ Supports RAID 0, 1, 5, 6, 10, 50, 60 and JBOD Mode.</li> <li>■ For all self-encrypting drives (SED), standalone Management (CIMC/UCSM) is supported for configuring and managing local keys. For now, SED drives are managed with local key management only. Third-party key management will be supported (KMIP compliant).</li> </ul>
UCSC-SAS-M5	Cisco 12G SAS HBA <ul style="list-style-type: none"> <li>■ Supports up to 10 internal SAS HDDs and SAS/SATA SSDs</li> <li>■ Supports JBOD mode only (no RAID functionality. Ideal for SDS (Software Defined Storage) applications. It is also ideal for environments demanding the highest IOPs (for external SSD attach), where a RAID controller can be an I/O bottleneck.</li> <li>■ No SED drive support</li> </ul>
<b>RAID Configuration Options (not available for Cisco 12G SAS HBA or embedded software RAID)</b>	
R2XX-SRAID0	Enable Single Disk Raid 0 Setting
R2XX-RAID0	Factory preconfigured RAID striping option Enable RAID 0 Setting. Requires a minimum of one hard drive.

Table 5 Hardware Controller Options (*continued*)

Product ID (PID)	PID Description
R2XX-RAID1	Factory preconfigured RAID mirroring option Enable RAID 1 Setting. Requires exactly two drives with the same size, speed, capacity.
R2XX-RAID5	Factory preconfigured RAID option Enable RAID 5 Setting. Requires a minimum of three drives of the same size, speed, capacity.
R2XX-RAID6	Factory preconfigured RAID option Enable RAID 6 Setting. Requires a minimum of four drives of the same size, speed, capacity.
R2XX-RAID10	Factory preconfigured RAID option Enable RAID 10 Setting. Requires a even number of drives (minimum of four drives) of the same size, speed, capacity.



**NOTE:** Although RAID levels 50 and 60 are not orderable from the factory, they are supported for selected controllers as shown in [Table 5](#).

---

### Approved Configurations

- The embedded software RAID default supports up to 8 internal SATA HDDs with RAID 0, 1, 10 support.
- The Cisco 12G SAS RAID controller upgrade option supports up to 10 internal drives with up to RAID 0, 1, 10, 5, 6, 50, 60 and JBOD mode support.
- The Cisco 12G SAS HBA upgrade option supports up to 10 internal drives with JBOD support.

See [Table 6](#) for a summary of the supported controller configuration options.

Table 6 Supported Controller Configurations for C220 M5 SFF Server

Server Model	# CPUs	Embedded RAID	Cisco 12G SAS RAID Controller or Cisco 12G SAS HBA ( <u>only one can be installed at a time</u> )		MAX# Drives Supported	RAID Support	Internal Drive Types Allowed
			Cisco 12G SAS RAID Controller	Cisco 12G SAS HBA			
C220 M5 SFF 10 Drives	1	Enabled	Not allowed	Not allowed	8 internal SATA only	0, 1, 10 (SATA only)	SATA HDDs/Enterprise Value SSDs
C220 M5 SFF 10 Drives	1	Not allowed	Installed in dedicated slot	Installed in dedicated slot	10 internal	0,1,10,5,6,50, 60 JBOD (12G SAS RAID), JBOD (SAS HBA)	SAS HDDs, SAS/SATA SSDs (NVMe requires 2 CPUs)
			Only one of the above can be installed at a time				
C220 M5 SFF 10 Drives	2	Enabled	Not allowed	Not allowed	8 internal SATA only	0, 1, 10 (SATA only)	SATA HDDs/Enterprise Value SSDs
C220 M5 SFF 10 Drives	2	Not allowed	Installed in dedicated slot	Installed in dedicated slot	10 internal	0,1,10,5,6,50, 60 JBOD (12G SAS RAID), JBOD (SAS HBA)	SAS HDDs, SAS/SATA SSDs, SFF NVMe
			Only one of the above can be installed at a time				



**NOTE:** There is no RAID support for NVMe. In an embedded RAID configuration, only embedded software RAID (0, 1, 10) is supported. AHCI mode is not supported.

## STEP 5 SELECT DRIVES

The standard disk drive features are:

- 2.5-inch small form factor
- Hot-pluggable
- Drives come mounted in sleds

### Select Drives

The available drives are listed in [Table 7](#).

**Table 7 Available Hot-Pluggable Sled-Mounted Drives**  
(UCSC-C220-M5S (10-drive system) and UCSC-C220-M5SN (10-drive NVMe only system))

Product ID (PID)	PID Description	Drive Type	Capacity
<b>HDDs (15K RPM)</b>			
UCS-HD300G15K12N	300 GB 12G SAS 15K RPM SFF HDD	SAS	300 GB
UCS-HD600G15K12N	600 GB 12G SAS 15K RPM SFF HDD	SAS	600 GB
UCS-HD900G15K12N	900 GB 12G SAS 15K RPM SFF HDD	SAS	900 GB
<b>HDDs (10K RPM)</b>			
UCS-HD300G10K12N	300 GB 12G SAS 10K RPM SFF HDD	SAS	300 GB
UCS-HD600G10K12N	600 GB 12G SAS 10K RPM SFF HDD	SAS	600 GB
UCS-HD12TB10K12N	1.2 TB 12G SAS 10K RPM SFF HDD	SAS	1.2 TB
UCS-HD18TB10K4KN <sup>1</sup>	1.8 TB 12G SAS 10K RPM SFF HDD (4K)	SAS	1.8 TB
<b>HDDs (7.2K RPM)</b>			
UCS-HD1T7K12N	1 TB 12G SAS 7.2K RPM SFF HDD	SAS	1 TB
UCS-HD2T7K12N	2 TB 12G SAS 7.2K RPM SFF HDD	SAS	2 TB
UCS-HD1T7K6GAN	1 TB 6G SATA 7.2K RPM SFF HDD	SAS	1 TB
<b>SAS/SATA SSDs<sup>2</sup></b>			
<b>Enterprise Performance SSDs (High endurance, supports up to 10X or 3X DWPD (drive writes per day))<sup>3</sup></b>			
UCS-SD400G12TX-EP	400 GB 2.5 inch Enterprise performance 12G SAS SSD (10X DWPD)	SAS	400 GB
UCS-SD800G12TX-EP	800 GB 2.5 inch Enterprise performance 12G SAS SSD (10X DWPD)	SAS	800 GB
UCS-SD16TB12TX-EP	1.6TB 2.5 inch Enterprise performance 12G SAS SSD(10X DWPD)	SAS	1.6 TB
UCS-SD400G123X-EP	400 GB 2.5 inch Enterprise performance 12G SAS SSD(3X DWPD)	SAS	400 GB
UCS-SD800G123X-EP	800 GB 2.5 inch Enterprise performance 12G SAS SSD(3X DWPD)	SAS	800 GB
UCS-SD16T123X-EP	1.6 TB 2.5 inch Enterprise performance 12G SAS SSD(3X DWPD)	SAS	1.6 TB
UCS-SD32T123X-EP	3.2 TB 2.5 inch Enterprise performance 12G SAS SSD(3X DWPD)	SAS	3.2 TB
UCS-SD480G63X-EP	480GB 2.5in Enterprise performance 6GSATA SSD(3X endurance) (Intel S4600)	SATA	480 GB
UCS-SD960G63X-EP	960GB 2.5in Enterprise performance 6GSATA SSD(3X endurance) (Intel S4600)	SATA	960 GB

Table 7 Available Hot-Pluggable Sled-Mounted Drives (*continued*)  
(UCSC-C220-M5S (10-drive system) and UCSC-C220-M5SN (10-drive NVMe only system))

Product ID (PID)	PID Description	Drive Type	Capacity
UCS-SD19T63X-EP	1.9TB 2.5in Enterprise performance 6GSATA SSD(3X endurance) (Intel S4600)	SATA	1.9 TB
<b>Enterprise Value SSDs (Low endurance, supports up to 1X DWPD (drive writes per day))<sup>4</sup></b>			
UCS-SD120GM1X-EV	120 GB 2.5 inch Enterprise Value 6G SATA SSD (Micron 5100 ECO)	SATA	120 GB
UCS-SD150G61X-EV	150 GB 2.5 inch Enterprise Value 6G SATA SSD (Intel S3520)	SATA	150 GB
UCS-SD240G61X-EV	240 GB 2.5 inch Enterprise Value 6G SATA SSD (Samsung PM863A)	SATA	240 GB
UCS-SD240GM1X-EV	240 GB 2.5 inch Enterprise Value 6G SATA SSD (Micron 5100 ECO)	SATA	240 GB
UCS-SD480G61X-EV	480 GB 2.5 inch Enterprise Value 6G SATA SSD (Samsung PM863A)	SATA	480 GB
UCS-SD480GM1X-EV	480 GB 2.5 inch Enterprise Value 6G SATA SSD (Micron 5100 ECO)	SATA	480 GB
UCS-SD480G121X-EV	480 GB 2.5 inch Enterprise Value 12G SAS SSD (Toshiba PM4)	SATA	480 GB
UCS-SD960G61X-EV	960 GB 2.5 inch Enterprise Value 6G SATA SSD (Samsung PM863A)	SATA	960 GB
UCS-SD960GM1X-EV	960 GB 2.5 inch Enterprise Value 6G SATA SSD (Micron 5100 ECO)	SATA	960 GB
UCS-SD960G121X-EV	960 GB 2.5 inch Enterprise Value 12G SAS SSD (Toshiba PM4)	SATA	960 GB
UCS-SD16T61X-EV	1.6 TB 2.5 inch Enterprise Value 6G SATA SSD (Intel S3520)	SATA	1.6 TB
UCS-SD16TM1X-EV	1.6 TB 2.5 inch Enterprise Value 6G SATA SSD (Micron 5100 ECO)	SATA	1.6 TB
UCS-SD19T61X-EV	1.9 TB 2.5 inch Enterprise Value 6G SATA SSD (Samsung PM863A)	SATA	1.9 TB
UCS-SD19TM1X-EV	1.9 TB 2.5 inch Enterprise Value 6G SATA SSD (Micron 5100 ECO)	SATA	1.9 TB
UCS-SD19TB121X-EV	1.9 TB 2.5 inch Enterprise Value 12G SAS SSD (Toshiba PM4)	SATA	1.9 TB
UCS-SD38T61X-EV	3.8 TB 2.5 inch Enterprise Value 6G SATA SSD (Samsung PM863A)	SATA	3.8 TB
UCS-SD38TM1X-EV	3.8 TB 2.5 inch Enterprise Value 6G SATA SSD (Micron 5100 ECO)	SATA	3.8 TB
UCS-SD38TB121X-EV	3.8 TB 2.5 inch Enterprise Value 12G SAS SSD (Toshiba PM4)	SATA	3.8 TB
UCS-SD76TM1X-EV	7.6 TB 2.5 inch Enterprise Value 6G SATA SSD (Micron 5100 ECO)	SATA	7.6 TB
UCS-SD480G611X-EV	480GB 2.5 inch Enterprise Value 6G SATA SSD (Intel S4500)	SATA	480 GB
UCS-SD960G611X-EV	960GB 2.5 inch Enterprise Value 6G SATA SSD (Intel S4500)	SATA	960 GB
UCS-SD38T611X-EV	3.8TB 2.5 inch Enterprise Value 6G SATA SSD (Intel S4500)	SATA	3.8 TB
<b>Self-Encrypted Drives (SED)</b>			
UCS-HD600G15NK9	600 GB 12G SAS 15K RPM SFF HDD (SED)	SAS	600 GB
UCS-HD12G10NK9	1.2 TB 12G SAS 10K RPM SFF HDD (SED)	SAS	1.2 TB
UCS-HD300G10NK9	300 GB 12G SAS 10K RPM SFF HDD (SED)	SAS	300 GB
UCS-SD400GBENK9	400 GB Enterprise performance SAS SSD (10X FWPD, SED)(Micron S650DC)	SAS	400 GB
UCS-SD800GBENK9	800 GB Enterprise performance SAS SSD (10X FWPD, SED)(Micron S650DC)	SAS	800 GB
UCS-SD16TBENK9	1.6 TB Enterprise performance SAS SSD (10X FWPD, SED)(Micron S650DC)	SAS	1.6 TB
<b>PCIe/NVMe SFF (2.5-inch) drives<sup>2</sup></b>			
UCSC-NVMEHW-H800	U.2 800 GB HGST SN200 NVMe High Perf. High Endurance (HGST)	NVMe	800 GB
UCSC-NVMEHW-H1600	U.2 1.6 TB HGST SN200 NVMe High Perf. High Endurance (HGST)	NVMe	1.6 TB



Table 7 Available Hot-Pluggable Sled-Mounted Drives (*continued*)  
(UCSC-C220-M5S (10-drive system) and UCSC-C220-M5SN (10-drive NVMe only system))

Product ID (PID)	PID Description	Drive Type	Capacity
UCSC-NVMEHW-H3200	U.2 3.2 TB HGST SN200 NVMe High Perf. High Endurance (HGST)	NVMe	3.2 TB
UCSC-NVMEHW-H6400	U.2 6.4TB HGST SN200 NVMe High Perf. High Endurance (HGST)	NVMe	6.4 TB
UCSC-NVMEHW-H7680	U.2 7.7 TB HGST SN200 NVMe High Perf. Value Endurance (HGST)	NVMe	7.7 TB

Notes:

1. Operating Systems supported on 4k sector size drives are as follows:

- Windows: Win2012 and Win2012R2
- Linux: RHEL 6.5/6.6/6.7/7.0/7.2/SLES 11 SP3 and SLES 12
- ESXi/VMware does not support 4k format drives; supports only 512e format drives

UEFI Mode must be used when booting from 4K sector size drives, legacy mode is not supported.

Ensure that 4K sector size and 512 byte sector size drives are not mixed in the same RAID volume.

2. Two CPUs must be installed in order to include any number of SFF NVMe PCIe SSDs. If you choose one or two SFF PCIe SSD or SFF NVMe drives, drive slots 1 and 2 at the front of the chassis are reserved for these drives (see [Figure 2 on page 4](#) for drive slot numbering)
3. Targeted for write centric IO applications. Supports endurance of 10 or 3 DWPD (drive writes per day). Target applications are caching, online transaction processing (OLTP), data warehousing, and virtual desktop infrastructure (VDI).
4. Targeted for read centric IO applications. Supports endurance of 1 DWPD (drive write per day). Target applications are boot, streaming media, and collaboration.

Caveats

- You can choose only SATA HDDs when using embedded software RAID. The UCSC-C220-M5SN does not support embedded RAID.
- SFF NVMe drives are connected directly to the CPU, not managed by the RAID controller.
- You can mix HDDs and SSDs as long as you keep all HDDs in their own RAID volume and all SSDs in their own RAID volume.
- You can mix SAS HDDs and SAS/SATA SSDs when using the Cisco 12G SAS RAID Controller or Cisco 12G SAS HBA.
- If you order any NVMe SFF drives, you must also order two CPUs.
- SFF NVMe drives are bootable in UEFI mode only.
- NVMe HHHH drives are not bootable.
- SED drives can be mixed with the non-SED drives in [Table 7 on page 22](#).

## STEP 6 SELECT PCIe OPTION CARD(s)

The standard PCIe card offerings are:

- Modular LAN on Motherboard (mLOM)
- Virtual Interface Cards (VICs)
- Network Interface Cards (NICs)
- Converged Network Adapters (CNAs)
- Host Bus Adapters (HBAs)
- UCS Storage Accelerators

### Select PCIe Option Cards

The available PCIe option cards are listed in [Table 8](#).

Table 8 Available PCIe Option Cards

Product ID (PID)	PID Description	Card Height
<b>Modular LAN on Motherboard (mLOM)</b>		
UCSC-MLOM-C40Q-03 <sup>1</sup>	Cisco VIC 1387 dual Port 40Gb QSFP CNA MLOM	N/A
UCSC-MLOM-IRJ45	Intel i350 quad port 1G copper MLOM	N/A
<b>Virtual Interface Cards (VICs)</b>		
UCSC-PCIE-C40Q-03 <sup>1</sup>	Cisco VIC 1385 dual Port 40Gb QSFP+ CNA w/RDMA	HHHL <sup>2</sup>
<b>Network Interface Cards (NICs)</b>		
<b>1 Gb NICs</b>		
UCSC-PCIE-IRJ45	Intel i350 quad Port 1Gb Adapter	HHHL
<b>10 Gb NICs</b>		
N2XX-AIPCI01	Intel X520 dual Port 10Gb SFP+ Adapter	HHHL
UCSC-PCIE-ID10GC	Intel X550-T2 dual-port 10GBase-T NIC	HHHL
UCSC-PCIE-ID10GF	Intel X710-DA2 dual-port 10G SFP+ NIC	HHHL
UCSC-PCIE-IQ10GF	Intel X710 quad-port 10G SFP+ NIC	Full
<b>25 Gb NICs</b>		
UCSC-PCIE-QD25GF	Qlogic QL41212H dual-port 25G NIC	HHHL
<b>40 Gb NIC</b>		
UCSC-PCIE-ID40GF	Intel XL710 dual-port 40G QSFP+	HHHL
<b>Host Bus Adapters (HBAs)</b>		
UCS-PCIE-QD16GF	Qlogic QLE2692 dual port 16G Fibre Channel HBA	HHHL
UCS-PCIE-BD16GF	Emulex/Broadcom LPe31000 dual port 16G Fibre Channel	HHHL
UCSC-PCIE-QD32GF	Qlogic QLE2742 dual port 32G FC HBA	HHHL

Table 8 Available PCIe Option Cards (*continued*)

Product ID (PID)	PID Description	Card Height
UCSC-PCIE-BS32GF	Emulex/Broadcom LPe32000-M2 single port 32G HBA Emulex/Broadcom	HHHL
UCSC-PCIE-BD32GF	LPe32002-M2 dual-port 32G HBA	HHHL
<b>UCS NVMe/PCIe Add in Cards</b>		
UCSC-NVME-H32003	Cisco HHHH AIC 1.6TB HGST SN260 NVMe Extreme Performance High Endurance	HHHL
UCSC-NVME-H32003	Cisco HHHH AIC 3.2TB HGST SN260 NVMe Extreme Performance High Endurance	HHHL
UCSC-NVME-H64003	Cisco HHHH AIC 6.4TB HGST SN260 NVMe Extreme Performance High Endurance	HHHL
UCSC-NVME-H38401	Cisco HHHH AIC 3.8TB HGST SN260 NVMe Extreme Performance High Endurance	HHHL
UCSC-NVME-H76801	Cisco HHHH AIC 7.7TB HGST SN260 NVMe Extreme Performance Value Endurance	HHHL

Notes:

1. VIC 1385 and 1387 support QSA module (CVR-QSFP-SFP10G)
2. HHHH= Half Height Half length

**Approved Configurations**

(1) 1-CPU Systems

- You can select up to one PCIe option card (slot 1 for 1-CPU systems) listed in [Table 8](#).

(2) 2-CPU Systems

- You can select up to two PCIe option cards (slots 1 and 2 for 2-CPU systems) listed in [Table 8](#).

**Caveats**

- For 1-CPU systems:
  - Only the full-height PCIe slot on riser 1 (slot 1) is supported
  - Only a single plug-in PCIe VIC card is supported and must be installed in slot 1 (the full-height slot). However, in addition to the one PCIe VIC card, you can also choose to install an mLOM VIC card.
- For 2-CPU systems:
  - Both PCIe slots(slots 1 and 2) are supported
  - Two plug-in PCIe VIC cards can be installed in 2-CPU systems, using slots 1 and 2. In addition, you can order an mLOM VIC card, which is installed in the mLOM slot inside the chassis and thus have three VIC cards in operation at the same time. See [Table 8 on page 25](#) for the selection of plug-in and mLOM VIC cards. See also [Table 1 on page 6](#).

- To help ensure that your operating system is compatible with the card you have selected, or to see additional cards that have been qualified to work with the UCS C220 M5 server, but are not sold on the Cisco pricelist, check the Hardware Compatibility List at this URL:

[http://www.cisco.com/en/US/products/ps10477/prod\\_technical\\_reference\\_list.html](http://www.cisco.com/en/US/products/ps10477/prod_technical_reference_list.html)

## STEP 7 ORDER POWER SUPPLY

Power supplies share a common electrical and physical design that allows for hot-plug and tool-less installation into M5 C-series servers. Each power supply is certified for high-efficiency operation and offer multiple power output options. This allows users to “right-size” based on server configuration, which improves power efficiency, lower overall energy costs and avoid stranded capacity in the data center. Use the power calculator at the following link to determine the needed power based on the options chosen (CPUs, drives, memory, and so on):

<http://ucspowercalc.cisco.com>

Table 9 Power Supply

Product ID (PID)	PID Description
UCSC-PSU1-770W	770W AC power supply for C-Series Servers
UCSC-PSU1-1050W	1050W AC power supply for C-Series servers
UCSC-PSUV2-1050DC	1050W DC power supply for C-Series servers
UCSC-PSU1-1600W	1600W power supply for C-Series servers



**NOTE:** In a server with two power supplies, both power supplies must be identical.

## STEP 8 SELECT POWER CORD(s)

Using [Table 10](#), select the appropriate AC power cords. You can select a minimum of no power cords and a maximum of two. If you select the option R2XX-DMYMPWRCORD, no power cord is shipped with the server.

Table 10 Available Power Cords

Product ID (PID)	PID Description	Images
R2XX-DMYMPWRCORD	No power cord (dummy PID to allow for a no power cord option)	Not applicable
CAB-48DC-40A-8AWG	C-Series -48VDC PSU Power Cord, 3.5M, 3 Wire, 8AWG, 40A	 <p>Figure 1-3 CAB-48DC-40A-8AWG, DC Power Cord (3.5M)</p>
CAB-N5K6A-NA	Power Cord, 200/240V 6A, North America	 <p>Plug: NEMA 6-15P Cordset rating: 10 A, 250 V Length: 8.2 ft Connector: IEC60320/C13</p>
CAB-AC-L620-C13	AC Power Cord, NEMA L6-20 - C13, 2M/6.5ft	 <p>3' From Plug End 70+2</p>
CAB-C13-CBN	CABASY,WIRE,JUMPER CORD, 27" L, C13/C14, 10A/250V	 <p>27" L</p>
CAB-C13-C14-2M	CABASY,WIRE,JUMPER CORD, PWR, 2 Meter, C13/C14,10A/250V	 <p>2 Meter</p>
CAB-C13-C14-AC	CORD,PWR,JMP,IEC60320/C14,IEC60320/C13, 3.0M	 <p>3.0M</p>

Table 10 Available Power Cords

Product ID (PID)	PID Description	Images
CAB-250V-10A-AR	Power Cord, 250V, 10A, Argentina	
CAB-9K10A-AU	Power Cord, 250VAC 10A 3112 Plug, Australia	
CAB-250V-10A-CN	AC Power Cord - 250V, 10A - PRC	
CAB-9K10A-EU	Power Cord, 250VAC 10A CEE 7/7 Plug, EU	
CAB-250V-10A-ID	Power Cord, 250V, 10A, India	
CAB-250V-10A-IS	Power Cord, SFS, 250V, 10A, Israel	
CAB-9K10A-IT	Power Cord, 250VAC 10A CEI 23-16/VII Plug, Italy	
CAB-9K10A-SW	Power Cord, 250VAC 10A MP232 Plug, Switzerland	

Table 10 Available Power Cords

Product ID (PID)	PID Description	Images
CAB-9K10A-UK	Power Cord, 250VAC 10A BS1363 Plug (13 A fuse), UK	
CAB-9K12A-NA	Power Cord, 125VAC 13A NEMA 5-15 Plug, North America	
CAB-250V-10A-BR	Power Cord - 250V, 10A - Brazil	
CAB-C13-C14-2M-JP	Power Cord C13-C14, 2M/6.5ft Japan PSE mark	Image not available

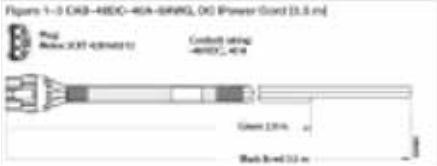
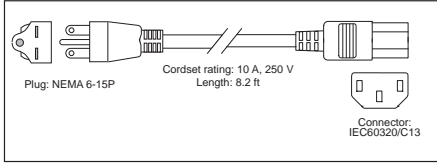
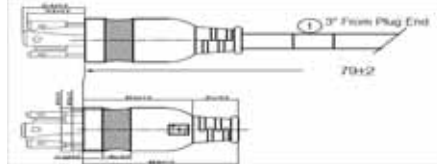
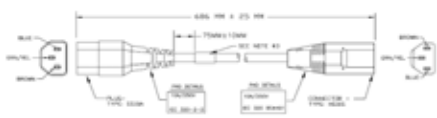
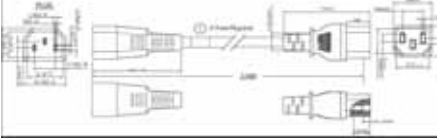
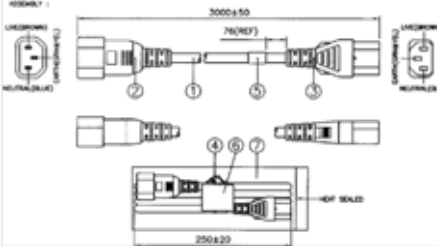

## STEP 9 ORDER TOOL-LESS RAIL KIT AND OPTIONAL REVERSIBLE CABLE MANAGEMENT ARM

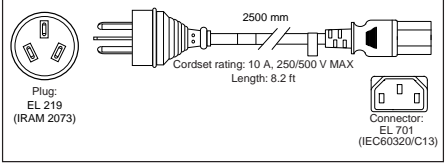
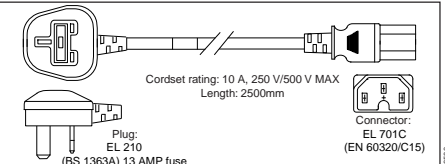
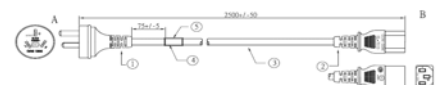
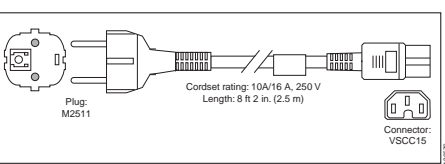
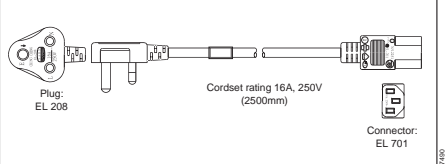
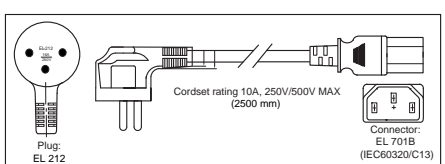
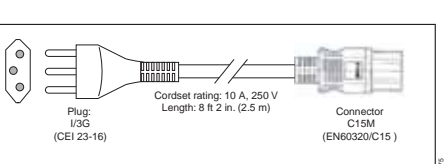
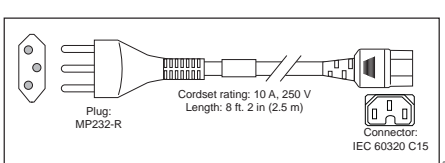
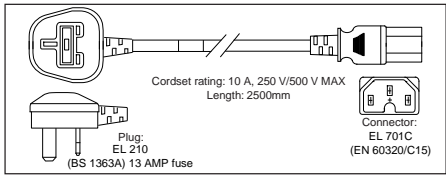
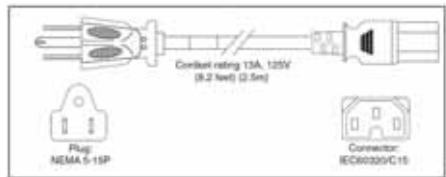
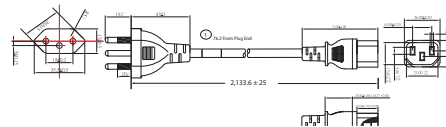
### Select a Tool-less Rail Kit

Select a tool-less rail kit from [Table 11](#).

Table 11 Tool-less Rail Kit Options

Product ID (PID)	PID Description
UCSC-RAILF-M4	Friction Rail Kit for C220 M4 and C220 M5 Servers
UCSC-RAILB-M4	Ball Bearing Rail Kit for C220 and C240 M4/M5 Rack Servers

### Select an Optional Reversible Cable Management Arm

The reversible cable management arm mounts on either the right or left slide rails at the rear of the server and is used for cable management. Use [Table 12](#) to order a cable management arm.

Table 12 Cable Management Arm

Product ID (PID)	PID Description
UCSC-CMAF-M4	Reversible CMA for C220 M4 & M5 rack servers

For more information about the tool-less rail kit and cable management arm, see the *Cisco UCS C220 M4 Installation and Service Guide* at this URL:

[http://www.cisco.com/c/en/us/td/docs/unified\\_computing/ucs/c/hw/C220M4/install/C220M4.html](http://www.cisco.com/c/en/us/td/docs/unified_computing/ucs/c/hw/C220M4/install/C220M4.html)



**NOTE:** If you plan to rackmount your UCS C220 M5 server, you must order a tool-less rail kit. The same rail kits and CMA's are used for M4 and M5 servers.

## STEP 10 SELECT MANAGEMENT CONFIGURATION (OPTIONAL)

By default, the C220 M5 server NIC mode is configured to be Shared LOM Extended. This NIC mode allows any LOM port or adapter card port to be used to access the Cisco Integrated Management Controller (CIMC). The Cisco VIC card must be installed in a slot with NCSI support.

To change the default NIC mode to Dedicated, select the UCSC-DLOM-01 PID shown in [Table 13](#). In Dedicated NIC mode, the CIMC can be accessed only through the dedicated management port. See [Chassis Rear View, page 5](#) for the location of the management port.

To change the default NIC mode to Cisco Card Mode, select the UCSC-CCARD-01 PID shown in [Table 13](#). In this mode, you can assign an IP address to the CIMC using DHCP and from there you can fully automate your deployment.

For more details on all the NIC mode settings, see

[http://www.cisco.com/c/en/us/td/docs/unified\\_computing/ucs/c/sw/gui/config/guide/2-0/b\\_Cisco\\_UCS\\_C-series\\_GUI\\_Configuration\\_Guide\\_201.pdf](http://www.cisco.com/c/en/us/td/docs/unified_computing/ucs/c/sw/gui/config/guide/2-0/b_Cisco_UCS_C-series_GUI_Configuration_Guide_201.pdf)

Table 13 Management Configuration Ordering Information

Product ID (PID)	PID Description
UCSC-DLOM-01	Dedicated Mode BIOS setting for C-Series Servers
UCSC-CCARD-01	Cisco Card Mode BIOS setting for C-Series Servers

## STEP 11 SELECT SERVER BOOT MODE (OPTIONAL)

By default, the C220 M5 server will ship with UEFI as the default boot mode. To have a server shipped with the Legacy BIOS mode (which was standard on M4 and previous generation servers), select the Legacy BIOS PID

Table 14 Server Boot Mode Ordering Information

Product ID (PID)	PID Description
UCSC-LBIOS-01	Legacy Boot Mode BIOS setting for C-Series Servers

## STEP 12 ORDER SECURITY DEVICES (OPTIONAL)

A Trusted Platform Module (TPM) is a computer chip (microcontroller) that can securely store artifacts used to authenticate the platform (server). These artifacts can include passwords, certificates, or encryption keys. A TPM can also be used to store platform measurements that help ensure that the platform remains trustworthy. Authentication (ensuring that the platform can prove that it is what it claims to be) and attestation (a process helping to prove that a platform is trustworthy and has not been breached) are necessary steps to ensure safer computing in all environments.

A chassis intrusion switch gives a notification of any unauthorized mechanical access into the server.

The security device ordering information is listed in [Table 15](#).

Table 15 Security Devices

Product ID (PID)	PID Description
UCSX-TPM2-001	Trusted Platform Module 1.2 SPI-based for UCS Servers
UCSX-TPM2-002	Trusted Platform Module 2.0 for UCS servers
UCSC-INT-SW01 <sup>1</sup>	C220 M5 and C240 M5 Chassis Intrusion Switch

**Notes:**

1. Available later in CY2017.



**NOTE:** The TPM module used in this system conforms to TPM v1.2 and 2.0, as defined by the Trusted Computing Group (TCG). It is also SPI-based.



**NOTE:** TPM installation is supported after-factory. However, a TPM installs with a one-way screw and cannot be replaced, upgraded, or moved to another server. If a server with a TPM is returned, the replacement server must be ordered with a new TPM.

## STEP 13 SELECT LOCKING SECURITY BEZEL (OPTIONAL)

An optional locking bezel can be mounted to the front of the chassis to prevent unauthorized access to the drives.

Select the locking bezel from [Table 16](#).

Table 16 Locking Bezel Option

Product ID (PID)	Description
UCSC-BZL-C220M5	C220 M5 Security Bezel

## STEP 14 ORDER CISCO SD CARD MODULE (OPTIONAL)

Order SD cards. See [Figure 6 on page 58](#) for the location of the SD cards. There are two locations, SD1 and SD2.

Table 17 Secure Digital (SD) Card (blank)

Product ID (PID)	PID Description
UCS-SD-128G	128 GB SD Card for UCS Servers
UCS-SD-64G-S	64 GB SD Card for UCS Servers
UCS-SD-32G-S	32 GB SD Card for UCS Servers

### Caveats

- Install either one or two SD cards
- Do not mix SD card sizes
- You cannot mix SD cards with an internal M.2 SATA SSD (see [ORDER M.2 SATA SSD \(OPTIONAL\), page 38](#)).

## STEP 15 ORDER M.2 SATA SSD (OPTIONAL)

Order one or two matching capacity M.2 SATA SSDs as desired.

Table 18 M.2 SATA SSDs

Product ID (PID)	PID Description
UCS-M2-240GB	240 GB M.2 SATA SSD
UCS-M2-960GB	960 GB M.2 SATA SSD

---

### Caveats

---

- Install either one or two M.2 SATA SSDs.
- You cannot mix M.2 SATA SSDs with SD cards (see [STEP 13 SELECT LOCKING SECURITY BEZEL \(OPTIONAL\), page 36](#))
- When Ordering two M.2 devices with embedded software RAID, the maximum number of internal SATA drives supported is six. To-support greater than 6 internal drives a cisco 12G Raid Controller or 12G SAS HBA must be ordered.

## STEP 16 ORDER INTERNAL MICRO-SD CARD MODULE (OPTIONAL)

Order a 32 GB micro-SD card.

The micro-SD card serves as a dedicated local resource for utilities such as HUU. Images can be pulled from a file share (NFS/CIFS) and uploaded to the cards for future use.

Table 19 32 GB Secure Digital (SD) Card (blank)

Product ID (PID)	PID Description
UCS-MSD-32G	32GB Micro-SD Card for UCS servers

Notes:

- The micro-SD card mounts internally on riser 1.



## STEP 17 ORDER OPTIONAL USB 3.0 DRIVE

You can order one optional USB 3.0 drive. The USB drive ordering information is listed in [Table 20](#).

Table 20 USB 3.0 Drive

Product ID (PID)	PID Description
UCS-USBFLSHB-16GB	UCS Servers 16 GB Flash USB Drive

See [Figure 5 on page 56](#) for the location of the USB connector.

## STEP 18 SELECT OPERATING SYSTEM AND VALUE-ADDED SOFTWARE

For more details on supported operating systems and software for this server, see the Hardware & Software Compatibility List (HCL).

**NOTE:** PIDs tagged with an asterisk (\*) are Resell of an OEM Vendor's Support. They are required to be added to the associated Product License PID.

Table 21 Software (for 2-CPU servers)

Product ID (PID)	PID Description
<b>Cisco One</b>	
C1F2PUCSK9	Cisco ONE Foundation Perpetual UCS
C1A1PUCSK9	Cisco ONE Enterprise Cloud Perpetual UCS
C1UCS-OPT-OUT	Cisco One Data Center Compute Opt Out Option
<b>Energy Management (JouleX)</b>	
CEM-DC-ENERGY	Cisco Energy Management (JouleX) Data Center License 1 Device
CEM-DC-3Y*	Cisco Energy Management-3 Yr for One DC physical end-device
CEM-DC-PER	Perpetual License Key for Cisco Energy Management for DC
<b>UCS Director</b>	
CUIC-PHY-SERV-BM-U	Cisco UCS Director Resource Lic - 1 Phy Sevr node bare metal
CUIC-PHY-SERV-U	Cisco UCS Director Resource Lic - One physical Server node
CUIC-TERM	Acceptance of Cisco UCS Director License Terms
<b>UCS Performance Manager</b>	
UCS-PM-IE	UCS Performance Manager
UCS-PM-EE	UCS Performance Manager Express
EVAL-UCS-PM-IE	UCS Performance Manager - 90 days evaluation
EVAL-UCS-PM-EE	UCS Performance Manager Express - 90 days evaluation
<b>Nexus 1000V for Hyper-V and vSphere</b>	
N1K-VSG-UCS-BUN	Nexus 1000V Adv Edition for vSphere Paper License Qty 1
<b>IMC Supervisor</b>	
CIMC-SUP-BASE-K9	IMC Supervisor One-time Site Installation License
CIMC-SUP-B01	IMC Supervisor-Branch Mgt SW for C-Series & E-Series upto 100 Svrs
CIMC-SUP-B02	IMC Supervisor- Branch Mgt SW for C & E-Series up to 250 Svrs
CIMC-SUP-B10	IMC Supervisor- Branch Mgt SW for C & E-Series up to 1K Svrs
CIMC-SUP-B25	IMC Supervisor Branch Mgt SW for C & E-Series 25 Svrs
CIMC-SUP-A01	IMC Supervisor Adv-Branch Mgt SW for C & E-Series 100 Svrs
CIMC-SUP-A02	IMC Supervisor Adv-Branch Mgt SW for C & E-Series 250 Svrs
CIMC-SUP-A10	IMC Supervisor Adv-Branch Mgt SW for C & E-Series 1000 Svrs
CIMC-SUP-A25	IMC Supervisor Adv-Branch Mgt SW for C & E-Series 250 Svrs
CIMC-SUP-TERM	Acceptance of Cisco IMC Supervisor License Terms
<b>UCS Multi-Domain Manager</b>	

Table 21 Software (for 2-CPU servers)

UCS-MDMGR-1S	UCS Central Per Server License <b>NOTE:</b> IF you must order quantity greater than 1 of UCS-MDMGR-1S, you need to reference the UCS Central Per Server Data Sheet to order the standalone PIDs: UCS-MDMGR-LIC= or UCS-MDMGR-1DMN=
<b>VMware vCenter</b>	
VMW-VCS-STD-1A	VMware vCenter 6 Server Standard, 1 yr support required
VMW-VCS-STD-3A	VMware vCenter 6 Server Standard, 3 yr support required
VMW-VCS-STD-5A	VMware vCenter 6 Server Standard, 5 yr support required
VMW-VCS-FND-1A	VMware vCenter 6 Server Foundation (3 Host), 1 yr supp reqd
VMW-VCS-FND-3A	VMware vCenter 6 Server Foundation (3 Host), 3 yr supp reqd
VMW-VCS-FND-5A	VMware vCenter 6 Server Foundation (3 Host), 5 yr supp reqd
<b>Microsoft Windows Server</b>	
MSWS-12R2-DC2S	Windows Server 2012 R2 Datacenter (2 CPU/Unlimited VMs)
MSWS-12R2-DC2S-NS	Windows Server 2012 R2 Datacen (2 CPU/Unlim VM) No Cisco Svc
MSWS-12R2-ST2S	Windows Server 2012 R2 Standard (2 CPU/2 VMs)
MSWS-12R2-ST2S-NS	Windows Server 2012 R2 Standard (2 CPU/2 VMs) No Cisco SVC
MSWS-12R2-ST2S-RM	Windows Server 2012 R2 Standard (2 CPU/2 VMs) Recovery Media
MSWS-12R2-DC2S-RM	Windows Server 2012 R2 Datacen(2 CPU/Unlimited VM) Rec Media
MSWS-16-ST16C	Windows Server 2016 Standard (16 Cores/2 VMs)
MSWS-16-ST24C	Windows Server 2016 Standard (24 Cores/2 VMs)
MSWS-16-ST16C-NS	Windows Server 2016 Standard (16 Cores/2 VMs) - No Cisco SVC
MSWS-16-ST24C-NS	Windows Server 2016 Standard (24 Cores/2 VMs) - No Cisco SVC
MSWS-16-DC16C	Windows Server 2016 Data Center (16 Cores/Unlimited VMs)
MSWS-16-DC24C	Windows Server 2016 Data Center (24 Cores/Unlimited VMs)
MSWS-16-DC16C-NS	Windows Server 2016 DC (16 Cores/Unlim VMs) - No Cisco SVC
MSWS-16-DC24C-NS	Windows Server 2016 DC (24 Cores/Unlim VMs) - No Cisco SVC
MSWS-16-STA2C	Windows Server 2016 Standard - Additional 2 Cores
MSWS-16-STA4C	Windows Server 2016 Standard - Additional 4 Cores
MSWS-16-STA16C	Windows Server 2016 Standard - Additional 16 Cores
MSWS-16-STA2C-NS	Windows Server 2016 Stan - Additional 2 Cores - No Cisco SVC
MSWS-16-STA4C- NS	Windows Server 2016 Stan - Additional 4 Cores - No Cisco SVC
MSWS-16-STA16C-NS	Windows Server 2016 Stan - Additional 16 Cores - No Cisco SVC
MSWS-16-DCA2C	Windows Server 2016 Data Center - Additional 2 Cores
MSWS-16-DCA4C	Windows Server 2016 Data Center - Additional 4 Cores
MSWS-16-DCA16C	Windows Server 2016 Data Center - Additional 16 Cores
MSWS-16-DCA2C-NS	Windows Server 2016 DC - Additional 2 Cores - No Cisco SVC
MSWS-16-DCA4C-NS	Windows Server 2016 DC - Additional 4 Cores - No Cisco SVC
MSWS-16-DCA16C-NS	Windows Server 2016 DC - Additional 16 Cores - No Cisco SVC
<b>Red Hat</b>	
RHEL-2S2V-1A	Red Hat Enterprise Linux (1-2 CPU,1-2 VN); 1-Yr Support Req
RHEL-2S2V-3A	Red Hat Enterprise Linux (1-2 CPU,1-2 VN); 3-Yr Support Req
RHEL-2S-HA-1A	RHEL High Availability (1-2 CPU); 1-Yr Support Reqd
RHEL-2S-HA-3A	RHEL High Availability (1-2 CPU); 3-Yr Support Reqd

Table 21 Software (for 2-CPU servers)

RHEL-2S-RS-1A	RHEL Resilient Storage (1-2 CPU); 1-Yr Support Reqd
RHEL-2S-RS-3A	RHEL Resilient Storage (1-2 CPU); 3-Yr Support Reqd
RHEL-2S-SFS-1A	RHEL Scalable File System (1-2 CPU); 1-Yr Support Reqd
RHEL-2S-SFS-3A	RHEL Scalable File System (1-2 CPU); 3-Yr Support Reqd
RHEL-2S2V-1S	Red Hat Enterprise Linux (1-2 CPU,1-2 VN); Prem 1-Yr SnS
RHEL-2S2V-1YR*	Red Hat Enterprise Linux (1-2 CPU,1-2 VN);Premium 24x7 - 1Yr
RHEL-2S2V-3S	Red Hat Enterprise Linux (1-2 CPU,1-2 VN); Prem 3-Yr SnS
RHEL-2S2V-3YR*	Red Hat Enterprise Linux (1-2 CPU,1-2 VN);Premium 24x7 - 3Yr
RHEL-2S-HA-1S	RHEL High Availability (1-2 CPU); Premium 1-yr SnS
RHEL-2S-HA-1YR*	RHEL High Availability (1-2 CPU); Premium 24x7 - 1 Year
RHEL-2S-HA-3S	RHEL High Availability (1-2 CPU); Premium 3-yr SnS
RHEL-2S-HA-3YR*	RHEL High Availability (1-2 CPU); Premium 24x7 - 3 Year
RHEL-2S-RS-1S	RHEL Resilient Storage (1-2 CPU); Premium 1-yr SnS
RHEL-2S-RS-1YR*	RHEL Resilient Storage (1-2 CPU); Premium 24x7 - 1 Year
RHEL-2S-RS-3S	RHEL Resilient Storage (1-2 CPU); Premium 3-yr SnS
RHEL-2S-RS-3YR*	RHEL Resilient Storage (1-2 CPU); Premium 24x7 - 3 Year
RHEL-2S-SFS-1S	RHEL Scalable File System (1-2 CPU); Premium 1-yr SnS
RHEL-2S-SFS-1YR*	RHEL Scalable File System (1-2 CPU); Premium 24x7 - 1 Year
RHEL-2S-SFS-3S	RHEL Scalable File System (1-2 CPU); Premium 3-yr SnS
RHEL-2S-SFS-3YR*	RHEL Scalable File System (1-2 CPU); Premium 24x7 - 3 Year
<b>Red Hat SAP</b>	
RHEL-SAPH-PR-1YR	RHEL for SAP Applications - Premium - RH SnS 1 Yr - 2 Socket
RHEL-SAPH-PR-3YR	RHEL for SAP Applications - Premium - RH SnS 3 Yr - 2 Socket
RHEL-SAPH-ST-1YR	RHEL for SAP Applications - Standard - RH SnS 1 Yr -2 Socket
RHEL-SAPH-ST-3YR	RHEL for SAP Applications - Standard - RH SnS 3 Yr -2 Socket
RHEL-SAP-2S2V-1S	RHEL for SAP Apps (1-2 CPU, 1-2 VN); Prem 1-Yr SnS
RHEL-SAP-2S2V-1YR*	RHEL for SAP Apps (1-2 CPU, 1-2 VN); Premium 24x7 - 1-Yr
RHEL-SAP-2S2V-3S	RHEL for SAP Apps (1-2 CPU, 1-2 VN); Prem 3-Yr SnS
RHEL-SAP-2S2V-3YR*	RHEL for SAP Apps (1-2 CPU, 1-2 VN); Premium 24x7 - 3-Yr
RHEL-SAPH-2S2V-1S	RHEL for SAP Hana (1-2 CPU, 1-2 VN); Prem 1-Yr SnS
RHEL-SAPH-2S2V-1YR*	RHEL for SAP Hana (1-2 CPU, 1-2 VN); Premium 24x7 - 1-Yr
RHEL-SAPH-2S2V-3S	RHEL for SAP Hana (1-2 CPU, 1-2 VN); Prem 3-Yr SnS
RHEL-SAPH-2S2V-3YR*	RHEL for SAP Hana (1-2 CPU, 1-2 VN); Premium 24x7 - 3-Yr
RHEL-SAPHHAS2S-1S	RHEL for SAP Hana,HA,SmartM (1-2 CPU & VN); Std 1Yr SnS Reqd
RHEL-SAPHHAS2S-1YR*	RHEL for SAP Hana,HA,SmartM (1-2 CPU & VN); Std 5x9 1Yr SnS
RHEL-SAPHHAS2S-3S	RHEL for SAP Hana,HA,SmartM (1-2 CPU & VN); Std 3Yr SnS Reqd
RHEL-SAPHHAS2S-3YR*	RHEL for SAP Hana,HA,SmartM (1-2 CPU & VN); Std 5x9 3Yr SnS
RHEL-SAPHHAP2S-1S	RHEL for SAP Hana,HA,SmartM (1-2 CPU &VN); Prem 1Yr SnS Reqd
RHEL-SAPHHAP2S-1YR*	RHEL for SAP Hana,HA,SmartM(1-2 CPU/VN); Prem 24x7 1Yr SnS
RHEL-SAPHHAP2S-3S	RHEL for SAP Hana,HA,SmartM (1-2 CPU &VN); Prem 3Yr SnS Reqd
RHEL-SAPHHAP2S-3YR*	RHEL for SAP Hana,HA,SmartM(1-2 CPU/VN); Prem 24x7 3Yr SnS
<b>VMware</b>	

Table 21 Software (for 2-CPU servers)

VMW-VSP-STD-1A	VMware vSphere 6 Standard (1 CPU), 1-yr, Support Required
VMW-VSP-STD-3A	VMware vSphere 6 Standard (1 CPU), 3-yr, Support Required
VMW-VSP-STD-5A	VMware vSphere 6 Standard (1 CPU), 5-yr, Support Required
VMW-VSP-EPL-3A	VMware vSphere 6 Ent Plus (1 CPU), 3-yr, Support Required
VMW-VSP-EPL-1A	VMware vSphere 6 Ent Plus (1 CPU), 1-yr, Support Required
VMW-VSP-EPL-5A	VMware vSphere 6 Ent Plus (1 CPU), 5-yr, Support Required
<b>SLES and SAP</b>	
SLES-SAP-2S2V-1A	SLES for SAP Apps (1-2 CPU, 1-2 VM); 1-Yr Support Reqd
SLES-SAP-2SUV-1A	SLES for SAP Apps (1-2 CPU, Unl VM); 1-Yr Support Reqd
SLES-SAP-2S2V-3A	SLES for SAP Apps (1-2 CPU, 1-2 VM); 3-Yr Support Reqd
SLES-SAP-2SUV-3A	SLES for SAP Apps (1-2 CPU, Unl VM); 3-Yr Support Reqd
SLES-SAP-2S2V-5A	SLES for SAP Apps (1-2 CPU, 1-2 VM); 5-Yr Support Reqd
SLES-SAP-2SUV-5A	SLES for SAP Apps (1-2 CPU, Unl VM); 5-Yr Support Reqd
SLES-SAP-2S2V-1S	SLES for SAP Apps (1-2 CPU, 1-2 VM); Priority 1-Yr SnS
SLES-SAP-2S2V-1YR*	SUSE for SAP Apps; (1-2 CPU,1-2 VM); Prio SnS 24x7 - 1 Year
SLES-SAP-2SUV-1S	SLES for SAP Apps (1-2 CPU, Unl VM); Priority 1-Yr SnS
SLES-SAP-2SUV-1YR*	SUSE for SAP Apps; (1-2 CPU,Unl VM); Prio SnS 24x7 - 1 Year
SLES-SAP-2S2V-3S	SLES for SAP Apps (1-2 CPU, 1-2 VM); Priority 3-Yr SnS
SLES-SAP-2S2V-3YR*	SUSE for SAP Apps; (1-2 CPU,1-2 VM); Prio SnS 24x7 - 3 Year
SLES-SAP-2SUV-3S	SLES for SAP Apps (1-2 CPU, Unl VM); Priority 3-Yr SnS
SLES-SAP-2SUV-3YR*	SUSE for SAP Apps; (1-2 CPU,Unl VM); Prio SnS 24x7 - 3 Year
SLES-SAP-2S2V-5S	SLES for SAP Apps (1-2 CPU, 1-2 VM); Priority 5-Yr SnS
SLES-SAP-2S2V-5YR*	SUSE for SAP Apps; (1-2 CPU,1-2 VM); Prio SnS 24x7 - 5 Year
SLES-SAP-2SUV-5S	SLES for SAP Apps (1-2 CPU, Unl VM); Priority 5-Yr SnS
SLES-SAP-2SUV-5YR*	SUSE for SAP Apps; (1-2 CPU,Unl VM); Prio SnS 24x7 - 5 Year
<b>SUSE</b>	
SLES-2S2V-1A	SUSE Linux Enterprise Svr (1-2 CPU,1-2 VM); 1-Yr Support Req
SLES-2SUV-1A	SUSE Linux Enterprise Svr (1-2 CPU,Unl VM); 1-Yr Support Req
SLES-2S2V-3A	SUSE Linux Enterprise Svr (1-2 CPU,1-2 VM); 3-Yr Support Req
SLES-2SUV-3A	SUSE Linux Enterprise Svr (1-2 CPU,Unl VM); 3-Yr Support Req
SLES-2S2V-5A	SUSE Linux Enterprise Svr (1-2 CPU,1-2 VM); 5-Yr Support Req
SLES-2SUV-5A	SUSE Linux Enterprise Svr (1-2 CPU,Unl VM); 5-Yr Support Req
SLES-2S2V-1S	SUSE Linux Enterprise Svr (1-2 CPU,1-2 VM); Prio 1-Yr SnS
SLES-2S2V-1YR*	SUSE Linux Entp Svr (1-2 CPU,1-2 VM); Prio SnS 24x7 - 1 Year
SLES-2SUV-1S	SUSE Linux Enterprise Svr (1-2 CPU,Unl VM); Prio 1-Yr SnS
SLES-2SUV-1YR*	SUSE Linux Entp Svr (1-2 CPU,Unl VM); Prio SnS 24x7 - 1 Year
SLES-2S2V-3S	SUSE Linux Enterprise Svr (1-2 CPU,1-2 VM); Prio 3-Yr SnS
SLES-2S2V-3YR*	SUSE Linux Entp Svr (1-2 CPU,1-2 VM); Prio SnS 24x7 - 3 Year
SLES-2SUV-3S	SUSE Linux Enterprise Svr (1-2 CPU,Unl VM); Prio 3-Yr SnS
SLES-2SUV-3YR*	SUSE Linux Entp Svr (1-2 CPU,Unl VM); Prio SnS 24x7 - 3 Year
SLES-2S2V-5S	SUSE Linux Enterprise Svr (1-2 CPU,1-2 VM); Prio 5-Yr SnS
SLES-2S2V-5YR*	SUSE Linux Entp Svr (1-2 CPU,1-2 VM); Prio SnS 24x7 - 5 Year

Table 21 Software (for 2-CPU servers)

SLES-2SUV-5S	SUSE Linux Enterprise Svr (1-2 CPU,Unl VM); Prio 5-Yr SnS
SLES-2SUV-5YR*	SUSE Linux Entp Svr (1-2 CPU,Unl VM); Prio SnS 24x7 - 5 Year
SLES-2S-HA-1S	SUSE Linux High Availability Ext (1-2 CPU); 1yr SnS
SLES-2S-HA-1YR*	SUSE Linux High Avail Ext (1-2 CPU); Inherited SnS - 1 Year
SLES-2S-HA-3S	SUSE Linux High Availability Ext (1-2 CPU); 3yr SnS
SLES-2S-HA-3YR*	SUSE Linux High Avail Ext (1-2 CPU); Inherited SnS - 3 Year
SLES-2S-HA-5S	SUSE Linux High Availability Ext (1-2 CPU); 5yr SnS
SLES-2S-HA-5YR*	SUSE Linux High Avail Ext (1-2 CPU); Inherited SnS - 1 Year
SLES-2S-GC-1S	SUSE Linux GEO Clustering for HA (1-2 CPU); 1yr Sns
SLES-2S-GC-1YR*	SUSE Linux Geo Clustering (1-2 CPU); Inherited SnS - 1 Year
SLES-2S-GC-3S	SUSE Linux GEO Clustering for HA (1-2 CPU); 3yr SnS
SLES-2S-GC-3YR*	SUSE Linux Geo Clustering (1-2 CPU); Inherited SnS - 3 Year
SLES-2S-GC-5S	SUSE Linux GEO Clustering for HA (1-2 CPU); 5yr SnS
SLES-2S-GC-5YR*	SUSE Linux Geo Clustering (1-2 CPU); Inherited SnS - 5 Year
SLES-2S-LP-1S	SUSE Linux Live Patching Add-on (1-2 CPU); 1yr SnS Required
SLES-2S-LP-1YR*	SUSE Linux Live Patching Add-on (1-2 CPU); Inherited SnS 1 Yr
SLES-2S-LP-3S	SUSE Linux Live Patching Add-on (1-2 CPU); 3yr SnS Required
SLES-2S-LP-3YR*	SUSE Linux Live Patching Add-on (1-2 CPU); Inherited SnS 3 Yr
<b>StorMagic</b>	
UCS-STORM-2TB-1S	StorMagic SvSAN Software License - 2TB - 1 Year SnS
UCS-STORM-2TB-1YR*	StorMagic SvSAN - Platinum Support - 2TB - 1 Year
UCS-STORM-2TB-3S	StorMagic SvSAN Software License - 2TB - 3 Year SnS
UCS-STORM-2TB-3YR*	StorMagic SvSAN - Platinum Support - 2TB - 3 Year
UCS-STORM-2TB-5S	StorMagic SvSAN Software License - 2TB - 5 Year SnS
UCS-STORM-2TB-5YR*	StorMagic SvSAN - Platinum Support - 2TB - 5 Year
UCS-STORM-6TB-1S	StorMagic SvSAN Software License - 6TB, 1 Node; 1Yr SnS Reqd
UCS-STORM-6TB-1YR*	StorMagic SvSAN - Platinum Support - 6TB - 1 Year
UCS-STORM-6TB-3S	StorMagic SvSAN Software License - 6TB, 1 Node; 3Yr SnS Reqd
UCS-STORM-6TB-3YR*	StorMagic SvSAN - Platinum Support - 6TB - 3 Year
UCS-STORM-6TB-5S	StorMagic SvSAN Software License - 6TB, 1 Node; 5Yr SnS Reqd
UCS-STORM-6TB-5YR*	StorMagic SvSAN - Platinum Support - 6TB - 5 Year
UCS-STORM-12TB-1S	StorMagic SvSAN Software License - 12TB, 1Node; 1Yr SnS Reqd
UCS-STORM-12TB-1Y*	StorMagic SvSAN - Platinum Support - 12TB - 1 Year
UCS-STORM-12TB-3S	StorMagic SvSAN Software License - 12TB, 1Node; 3Yr SnS Reqd
UCS-STORM-12TB-3Y*	StorMagic SvSAN - Platinum Support - 12TB - 3 Year
UCS-STORM-12TB-5S	StorMagic SvSAN Software License - 12TB, 1Node; 5Yr SnS Reqd
UCS-STORM-12TB-5Y*	StorMagic SvSAN - Platinum Support - 12TB - 5 Year
UCS-STORM-UTB-1S	StorMagic SvSAN Software License - Unlimited TB - 1 Yr SnS

Table 21 Software (for 2-CPU servers)

UCS-STORM-UTB-1YR*	StorMagic SvSAN - Platinum Support - Unlimited TB - 1 Year
UCS-STORM-UTB-3S	StorMagic SvSAN Software License - Unlimited TB - 3 Yr SnS
UCS-STORM-UTB-3YR*	StorMagic SvSAN - Platinum Support - Unlimited TB - 3 Year
UCS-STORM-UTB-5S	StorMagic SvSAN Software License - Unlimited TB - 5 Yr SnS
UCS-STORM-UTB-5YR*	StorMagic SvSAN - Platinum Support - Unlimited TB - 5 Year
UCS-STORM-2TA-1S	StorMagic SvSAN Adv SW License - 2TB, 1 Node; 1Yr SnS Reqd
UCS-STORM-2TA-1Y*	StorMagic SvSAN - Adv Platinum Support - 2TB - 1 Year
UCS-STORM-2TA-3S	StorMagic SvSAN Adv SW License - 2TB, 1 Node; 3Yr SnS Reqd
UCS-STORM-2TA-3Y*	StorMagic SvSAN - Adv Platinum Support - 2TB - 3 Year
UCS-STORM-2TA-5S	StorMagic SvSAN Adv SW License - 2TB, 1 Node; 5Yr SnS Reqd
UCS-STORM-2TA-5Y*	StorMagic SvSAN - Adv Platinum Support - 2TB - 5 Year
UCS-STORM-6TA-1S	StorMagic SvSAN Adv SW License - 6TB, 1 Node; 1Yr SnS Reqd
UCS-STORM-6TA-1Y*	StorMagic SvSAN - Adv Platinum Support - 6TB - 1 Year
UCS-STORM-6TA-3S	StorMagic SvSAN Adv SW License - 6TB, 1 Node; 3Yr SnS Reqd
UCS-STORM-6TA-3Y*	StorMagic SvSAN - Adv Platinum Support - 6TB - 3 Year
UCS-STORM-6TA-5S	StorMagic SvSAN Adv SW License - 6TB, 1 Node; 5Yr SnS Reqd
UCS-STORM-6TA-5Y*	StorMagic SvSAN - Adv Platinum Support - 6TB - 5 Year
UCS-STORM-12TA-1S	StorMagic SvSAN Adv SW License - 12TB, 1 Node; 1Yr SnS Reqd
UCS-STORM-12TA-1Y*	StorMagic SvSAN - Adv Platinum Support - 12TB - 1 Year
UCS-STORM-12TA-3S	StorMagic SvSAN Adv SW License - 12TB, 1 Node; 3Yr SnS Reqd
UCS-STORM-12TA-3Y*	StorMagic SvSAN - Adv Platinum Support - 12TB - 3 Year
UCS-STORM-12TA-5S	StorMagic SvSAN Adv SW License - 12TB, 1 Node; 5Yr SnS Reqd
UCS-STORM-12TA-5Y*	StorMagic SvSAN - Adv Platinum Support - 12TB - 5 Year
UCS-STORM-UTA-1S	StorMagic SvSAN Adv SW Lic - Unlim TB, 1Node; 1Yr SnS Reqd
UCS-STORM-UTA-1Y*	StorMagic SvSAN - Adv Platinum Support - Unlimited TB - 1 Yr
UCS-STORM-UTA-3S	StorMagic SvSAN Adv SW Lic - Unlim TB, 1Node; 3Yr SnS Reqd
UCS-STORM-UTA-3Y*	StorMagic SvSAN - Adv Platinum Support - Unlimited TB - 3 Yr
UCS-STORM-UTA-5S	StorMagic SvSAN Adv SW Lic - Unlim TB, 1Node; 5Yr SnS Reqd
UCS-STORM-UTA-5Y*	StorMagic SvSAN - Adv Platinum Support - Unlimited TB - 5 Yr

## STEP 19 SELECT OPERATING SYSTEM MEDIA KIT

Select the optional operating system media listed in [Table 22](#).

Table 22 OS Media

Product ID (PID)	PID Description
MSWS-12R2-ST2S-RM	Windows Server 2012 R2 Standard (2 CPU/2 VMs) Recovery Media
MSWS-12R2-DC2S-RM	Windows Server 2012 R2 Datacen(2 CPU/Unlimited VM) Rec Media
MSWS-16-ST16C-RM	Windows Server 2016 Stan (16 Cores/2 VMs) - Recovery Media
MSWS-16-ST24C-RM	Windows Server 2016 Stan (24 Cores/2 VMs) - Recovery Media
MSWS-16-DC16C-RM	Windows Server 2016 DC (16 Cores/Unlim VMs) - Recovery Media
MSWS-16-DC24C-RM	Windows Server 2016 DC (24 Cores/Unlim VMs) - Recovery Media



## STEP 20 SELECT SERVICE and SUPPORT LEVEL

A variety of service options are available, as described in this section.

### Unified Computing Warranty, No Contract

If you have noncritical implementations and choose to have no service contract, the following coverage is supplied:

- Three-year parts coverage.
- Next business day (NBD) parts replacement eight hours a day, five days a week.
- 90-day software warranty on media.
- Downloads of BIOS, drivers, and firmware updates.
- UCSM updates for systems with Unified Computing System Manager. These updates include minor enhancements and bug fixes that are designed to maintain the compliance of UCSM with published specifications, release notes, and industry standards.

### Smart Net Total Care (SNTC) for UCS

For support of the entire Unified Computing System, Cisco offers the Cisco Smart Net Total Care for UCS Service. This service provides expert software and hardware support to help sustain performance and high availability of the unified computing environment. Access to Cisco Technical Assistance Center (TAC) is provided around the clock, from anywhere in the world

For systems that include Unified Computing System Manager, the support service includes downloads of UCSM upgrades. The Cisco Smart Net Total Care for UCS Service includes flexible hardware replacement options, including replacement in as little as two hours. There is also access to Cisco's extensive online technical resources to help maintain optimal efficiency and uptime of the unified computing environment. For more information please refer to the following url: <http://www.cisco.com/c/en/us/services/technical/smart-net-total-care.html?stickynav=1>

You can choose a desired service listed in [Table 23](#).

**Table 23 Cisco SNTC for UCS Service (PID UCSC-C220-M5SX)**

Service SKU	Service Level GSP	On Site?	Description
CON-PREM-C220M5SX	C2P	Yes	SNTC 24X7X2OS
CON-UCSD8-C220M5SX	UCSD8	Yes	UC SUPP DR 24X7X2OS*
CON-C2PL-C220M5SX	C2PL	Yes	LL 24X7X2OS**
CON-OSP-C220M5SX	C4P	Yes	SNTC 24X7X4OS
CON-UCSD7-C220M5SX	UCSD7	Yes	UCS DR 24X7X4OS*
CON-C4PL-C220M5SX	C4PL	Yes	LL 24X7X4OS**
CON-USD7L-C220M5SX	USD7L	Yes	LLUCS HW DR 24X7X4OS***
CON-OSE-C220M5SX	C4S	Yes	SNTC 8X5X4OS
CON-UCSD6-C220M5SX	UCSD6	Yes	UC SUPP DR 8X5X4OS*
CON-SNCO-C220M5SX	SNCO	Yes	SNTC 8x7xNCDOS****
CON-OS-C220M5SX	CS	Yes	SNTC 8X5XNBDOS
CON-UCSD5-C220M5SX	UCSD5	Yes	UCS DR 8X5XNBDOS*

Table 23 Cisco SNTC for UCS Service (PID UCSC-C220-M5SX)

Service SKU	Service Level GSP	On Site?	Description
CON-S2P-C220M5SX	S2P	No	SNTC 24X7X2
CON-S2PL-C220M5SX	S2PL	No	LL 24X7X2**
CON-SNTP-C220M5SX	SNTP	No	SNTC 24X7X4
CON-SNTPL-C220M5SX	SNTPL	No	LL 24X7X4**
CON-SNTE-C220M5SX	SNTE	No	SNTC 8X5X4
CON-SNC-C220M5SX	SNC	No	SNTC 8x7xNCD****
CON-SNT-C220M5SX	SNT	No	SNTC 8X5XNBD
CON-SW-C220M5SX	SW	No	SNTC NO RMA

Note: For PID UCSC-C220-M5SN, select Service SKU with C220M5SN suffix (Example: CON-PREM-C220M5SN)

\*Includes Drive Retention (see below for full description)

\*\*Includes Local Language Support (see below for full description) – Only available in China and Japan

\*\*\*Includes Local Language Support and Drive Retention – Only available in China and Japan

\*\*\*\*Available in China Only

#### Smart Net Total Care for Cisco UCS Onsite Troubleshooting Service

An enhanced offer over traditional Smart Net Total Care which provides onsite-troubleshooting expertise to aid in the diagnostics and isolation of hardware issue within our customers' Cisco Unified Computing System (UCS) environment. It is delivered by a Cisco Certified field engineer (FE) in collaboration with remote TAC engineer and Virtual Internet working Support Engineer (VISE). You can choose a desired service listed in [Table 24](#)

Table 24 SNTC for Cisco UCS Onsite Troubleshooting Service (PID UCSC-C220-M5SX )

Service SKU	Service Level GSP	On Site?	Description
CON-OSPT-C220M5SX	OSPT	Yes	24X7X4OS Trblshtg
CON-OSPTD-C220M5S	OSPTD	Yes	24X7X4OS TrblshtgDR*
CON-OSPTL-C220M5SX	OSPTL	Yes	24X7X4OS TrblshtgLL**
CON-OPTLD-C220M5S	OPTLD	Yes	24X7X4OS TrblshtgLLD***

\*Includes Drive Retention (see below for full description)

\*\*Includes Local Language Support (see below for full description) – Only available in China and Japan

\*\*\*Includes Local Language Support and Drive Retention – Only available in China and Japan

## Solution Support for UCS

Solution Support includes both Cisco product support and solution-level support, resolving complex issues in multivendor environments, on average, 43% more quickly than product support alone. Solution Support is a critical element in data center administration, to help rapidly resolve any issue encountered, while maintaining performance, reliability, and return on investment.

This service centralizes support across your multivendor Cisco environment for both our products and solution partner products you've deployed in your ecosystem. Whether there is an issue with a Cisco or solution partner product, just call us. Our experts are the primary point of contact and own the case from first call to resolution. For more information please refer to the following url:

<http://www.cisco.com/c/en/us/services/technical/solution-support.html?stickynav=1>

You can choose a desired service listed in [Table 25](#)

**Table 25 Solution Support for UCS Service (PID UCSC-C220-M5SX)**

Service SKU	Service Level GSP	On Site?	Description
CON-SSC2P-C220M5SX	SSC2P	Yes	SOLN SUPP 24X7X2OS
CON-SSC4P-C220M5SX	SSC4P	Yes	SOLN SUPP 24X7X4OS
CON-SSC4S-C220M5SX	SSC4S	Yes	SOLN SUPP 8X5X4OS
CON-SSCS-C220M5SX	SSCS	Yes	SOLN SUPP 8X5XNBDOS
CON-SSDR7-C220M5SX	SSDR7	Yes	SSPT DR 24X7X4OS*
CON-SSDR5-C220M5SX	SSDR5	Yes	SSPT DR 8X5XNBDOS*
CON-SSS2P-C220M5SX	SSS2P	No	SOLN SUPP 24X7X2
CON-SSSNP-C220M5SX	SSSNP	No	SOLN SUPP 24X7X4
CON-SSSNE-C220M5SX	SSSNE	No	SOLN SUPP 8X5X4
CON-SSSNC-C220M5SX	SSSNC	No	SOLN SUPP NCD**
CON-SSSNT-C220M5SX	SSSNT	No	SOLN SUPP 8X5XNBD

Includes Drive Retention (see below for description)

\*\*Available in China only

### Smart Net Total Care for UCS Hardware Only Service

For faster parts replacement than is provided with the standard Cisco Unified Computing System warranty, Cisco offers the Cisco Smart Net Total Care for UCS Hardware Only Service. You can choose from two levels of advanced onsite parts replacement coverage in as little as four hours. Smart Net Total Care for UCS Hardware Only Service provides remote access any time to Cisco

support professionals who can determine if a return materials authorization (RMA) is required. You can choose a desired service listed in [Table 26](#)

**Table 26 SNTC for UCS Hardware Only Service (PID UCSC-C220-M5SX)**

Service SKU	Service Level GSP	On Site?	Description
CON-UCW7-C220M5SX	UCW7	Yes	UCS HW 24X7X4OS
CON-UCWD7-C220M5SX	UCWD7	Yes	UCS HW+DR 24X7X4OS*
CON-UCW7L-C220M5SX	UCW7L	Yes	LL UCS 24X7X4OS**
CON-UWD7L-C220M5SX	UWD7L	Yes	LL UCS DR 24X7X4OS***
CON-UCW5-C220M5SX	UCW5	Yes	UCS HW 8X5XNBDOS
CON-UCWD5-C220M5SX	UCWD5	Yes	UCS HW+DR 8X5XNBDOS*

Note: For PID UCSC-C220-M5SN, select Service SKU with C220M5SN suffix (Example: CON-UCW7-C220M5SN)

\*Includes Drive Retention (see below for description)

\*\*Includes Local Language Support (see below for full description) - Only available in China and Japan

\*\*\*Includes Local Language Support and Drive Retention - Only available in China and Japan

### Partner Support Service for UCS

Cisco Partner Support Service (PSS) is a Cisco Collaborative Services service offering that is designed for partners to deliver their own branded support and managed services to enterprise customers. Cisco PSS provides partners with access to Cisco's support infrastructure and assets to help them:

- Expand their service portfolios to support the most complex network environments
- Lower delivery costs
- Deliver services that increase customer loyalty

PSS options enable eligible Cisco partners to develop and consistently deliver high-value technical support that capitalizes on Cisco intellectual assets. This helps partners to realize higher margins and expand their practice.

PSS is available to all Cisco PSS partners.

The two Partner Unified Computing Support Options include:

- Partner Support Service for UCS
- Partner Support Service for UCS Hardware Only

PSS for UCS provides hardware and software support, including triage support for third party software, backed by Cisco technical resources and level three support. You can choose a desired service listed in [Table 27](#).

**Table 27 PSS for UCS (PID UCSC-C220-M5SX)**

Service SKU	Service Level GSP	On Site?	Description
CON-PSJ8-C220M5SX	PSJ8	Yes	UCS PSS 24X7X2 OS

Table 27 PSS for UCS (PID UCSC-C220-M5SX)

CON-PSJ7-C220M5SX	PSJ7	Yes	UCS PSS 24X7X4 OS
CON-PSJD7-C220M5SX	PSJD7	Yes	UCS PSS 24X7X4 DR*
CON-PSJ6-C220M5SX	PSJ6	Yes	UCS PSS 8X5X4 OS
CON-PSJD6-C220M5SX	PSJD6	Yes	UCS PSS 8X5X4 DR*
CON-PSJ4-C220M5SX	PSJ4	No	UCS SUPP PSS 24X7X2
CON-PSJ3-C220M5SX	PSJ3	No	UCS SUPP PSS 24X7X4
CON-PSJ2-C220M5SX	PSJ2	No	UCS SUPP PSS 8X5X4
CON-PSJ1-C220M5SX	PSJ1	No	UCS SUPP PSS 8X5XNBD

Note: For PID UCSC-C220-M5SN, select Service SKU with C220M5SN suffix (Example: CON-PSJ1-C220M5SN)

\*Includes Drive Retention (see below for description)

### PSS for UCS Hardware Only

PSS for UCS Hardware Only provides customers with replacement parts in as little as two hours and provides remote access any time to Partner Support professionals who can determine if a return materials authorization (RMA) is required. You can choose a desired service listed in [Table 28](#)

Table 28 PSS for UCS Hardware Only (PID UCSC-C220-M5SX)

Service SKU	Service Level GSP	On Site?	Description
CON-PSW7-C220M5SX	PSW7	Yes	UCS W PSS 24X7X4 OS
CON-PSWD7-C220M5SX	PSWD7	Yes	UCS W PSS 24X7X4 DR*
CON-PSW6-C220M5SX	PSW6	Yes	UCS W PSS 8X5X4 OS
CON-PSWD6-C220M5SX	PSWD6	Yes	UCS W PSS 8X5X4 DR*
CON-PSW4-C220M5SX	PSW4	No	UCS W PL PSS 24X7X2
CON-PSW3-C220M5SX	PSW3	No	UCS W PL PSS 24X7X4
CON-PSW2-C220M5SX	PSW2	No	UCS W PL PSS 8X5X4

Note: For PID UCSC-C220-M5SN, select Service SKU with C220M5SN suffix (Example: CON-PSW2-C220M5SN)

\*Includes Drive Retention (see below for description)

### Unified Computing Combined Support Service

Combined Services makes it easier to purchase and manage required services under one contract. SNTC services for UCS help increase the availability of your vital data center infrastructure and realize the most value from your unified computing investment. The more benefits you realize from the Cisco Unified Computing System (Cisco UCS), the more important the technology becomes to your business. These services allow you to:

- Optimize the uptime, performance, and efficiency of your UCS
- Protect your vital business applications by rapidly identifying and addressing issues
- Strengthen in-house expertise through knowledge transfer and mentoring

- Improve operational efficiency by allowing UCS experts to augment your internal staff resources
- Enhance business agility by diagnosing potential issues before they affect your operations,

You can choose a desired service listed in [Table 29](#)

**Table 29 Combined Support Service for UCS (PID UCSC-C220-M5SX)**

Service SKU	Service Level GSP	On Site?	Description
CON-NCF2P-C220M5SX	NCF2P	Yes	CMB SVC 24X7X2OS
CON-NCF4P-C220M5SX	NCF4P	Yes	CMB SVC 24X7X4OS
CON-NCF4S-C220M5SX	NCF4S	Yes	CMB SVC 8X5X4OS
CON-NCFCS-C220M5SX	NCFCS	Yes	CMB SVC 8X5XNBDOS
CON-NCF2-C220M5SX	NCF2	No	CMB SVC 24X7X2
CON-NCFP-C220M5SX	NCFP	No	CMB SVC 24X7X4
CON-NCFE-C220M5SX	NCFE	No	CMB SVC 8X5X4
CON-NCFT-C220M5SX	NCFT	No	CMB SVC 8X5XNBD
CON-NCFW-C220M5SX	NCFW	No	CMB SVC SW

Note: For PID UCSC-C220-M5SN, select Service SKU with C220M5SN suffix (Example: CON-NCF2P-C220M5SN)

### UCS Drive Retention Service

With the Cisco Unified Computing Drive Retention Service, you can obtain a new disk drive in exchange for a faulty drive without returning the faulty drive.

Sophisticated data recovery techniques have made classified, proprietary, and confidential information vulnerable, even on malfunctioning disk drives. The Drive Retention service enables you to retain your drives and ensures that the sensitive data on those drives is not compromised, which reduces the risk of any potential liabilities. This service also enables you to comply with regulatory, local, and federal requirements.

If your company has a need to control confidential, classified, sensitive, or proprietary data, you might want to consider one of the Drive Retention Services listed in the above tables (where available)



**NOTE:** Cisco does not offer a certified drive destruction service as part of this service.

### Local Language Technical Support for UCS

Where available, and subject to an additional fee, local language support for calls on all assigned severity levels may be available for specific product(s) - see tables above.

For a complete listing of available services for Cisco Unified Computing System, see the following URL:

[http://www.cisco.com/en/US/products/ps10312/serv\\_group\\_home.html](http://www.cisco.com/en/US/products/ps10312/serv_group_home.html)

## OPTIONAL STEP - ORDER RACK(S)

The optional R42612 rack is available from Cisco for the C-Series servers, including the C220 M5 SFF server. This rack is a standard 19-inch rack and can be ordered with a variety of options, as listed in [Table 30](#). Racks are shipped separately from the C220 M5 SFF server.

Table 30 Racks and Rack Options

Product ID (PID)	PID Description
RACK2-UCS	Cisco R42612 expansion rack, no side panels.
RACK2-UCS2	This type of rack is used for multiple-rack deployments. Cisco R42612 static (standard) rack, with side panels.
RACK-BLANK-001	This type of rack is used for single-rack and end of row deployments. Side panels are needed for racks at the ends of multiple-rack deployments. For example, when configuring a row of 5 racks, order 1 standard rack plus 4 expansion racks. Apply the side panels from the standard rack to the racks at each end of the row. Blanking panels (qty 12), 1U, plastic, toolless.
RACK-CBLMGT-001	Recommended to ensure proper airflow. Fill all empty RU spaces in the front of the rack. Because each blanking panel PID includes 12 panels, use the following calculation: 42RU - occupied RU = available RU. Divide available RU by 12 to determine PID order quantity. Cable mgt D rings (qty 10), metal.
RACK-CBLMGT-003	Use the D rings to bundle system cables to ensure proper airflow. Brush strip (qty 1), 1 U.
RACK-CBLMGT-011	The brush strip promotes proper airflow while allowing cables to be passed from the front to the rear of the rack. Cable mgt straps (qty 10), Velcro.
RACK-FASTEN-001	Use the Velcro straps to bundle system cables to ensure proper airflow. Mounting screws (qty 100), M6.
RACK-FASTEN-002	The rack ships with nuts and screws, but extras may be ordered. Cage nuts (qty 50), M6.
RACK2-JOIN-001	The rack ships with nuts and screws, but extras may be ordered. Rack joining kit.
RACK2-GRND-001	Use the kit to connect adjacent racks within a row. Order 1 unit less than the number of racks in the row. Cisco R42612 grounding kit

For more information about the R42612 rack, see [RACKS, page 64](#).

## OPTIONAL STEP - ORDER PDU

An optional power distribution unit (PDU) is available from Cisco for the C-Series rack servers. This PDU is available in a zero rack unit (RU) style or horizontal PDU style see Cisco RP-Series Rack and Rack PDU specification for more details at

<http://www.cisco.com/c/dam/en/us/products/collateral/servers-unified-computing/r-series-racks/rack-pdu-specsheet.pdf>



# SUPPLEMENTAL MATERIAL

## CHASSIS

An internal view of the C220 M5 chassis with the top cover removed is shown in *Figure 5*.

Figure 5 C220 M5 SFF With Top Cover Off

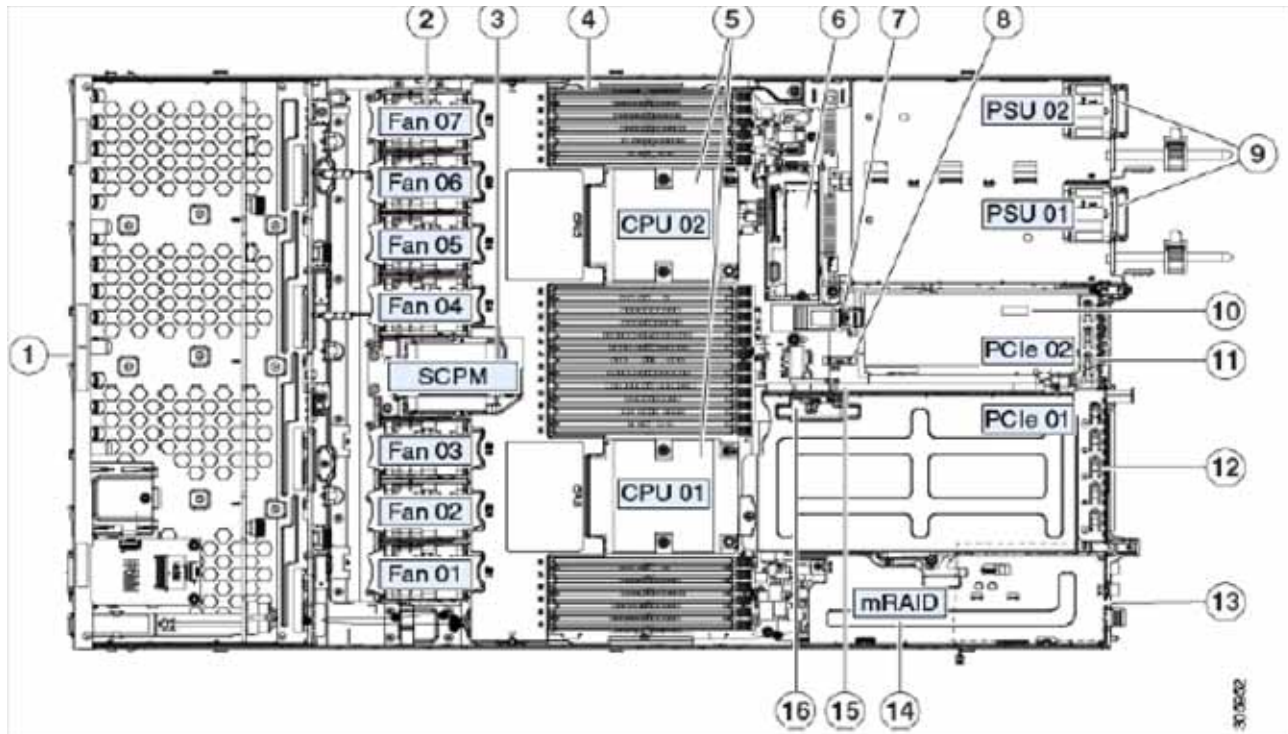

1	<p>For UCSC-C220-M5SX: Drive bays 1-10 support SAS/SATA drives and drive bays 1 and 2 also support SFF NVMe PCIe SSDs.</p> <p>For UCSC-C220-M5SN: Drive bays 1-10 support SFF NVMe PCIe SSDs (only)</p>	9	Power supplies (Hot-swappable when redundant as 1+1)
2	Cooling fan modules (seven)	10	Trusted platform module (TPM) socket on motherboard (not visible in this view)
3	Supercap Power Module (RAID backup) mounting bracket	11	PCIe slot 2 (half-height, x16); includes PCIe cable connector for SFF NVMe SSDs (x8)
4	DIMM sockets on motherboard (up to 12 per CPU; total 24)	12	PCIe slot 1 (full-height, x16); includes socket for Micro-SD card
5	CPUs and heatsinks (up to two)	13	Modular LOM (mLOM) card bay on chassis floor (x16) (not visible in this view)

6	Mini storage module connector Supports either an SD card module with two SD cards or an M.2 module with two PCIe/SATA M.2 SSD slots	14	Modular RAID (mRAID) riser, can optionally be a riser that supports either: <ul style="list-style-type: none"><li>■ Hardware RAID controller card</li><li>■ Interposer card for embedded SATA RAID</li><li>■ PCIe switch card for SFF NVMe drives in slots 3 through 10 (for UCSC-C220-M5SN)</li></ul>
7	Internal USB 3.0 port on motherboard	15	PCIe cable connectors for front-panel NVMe SSDs on PCIe riser 2
8	RTC battery vertical socket on motherboard	16	Micro-SD card socket on PCIe riser 1

# Block Diagram

Figure 6 C220 M5 SFF Block Diagram

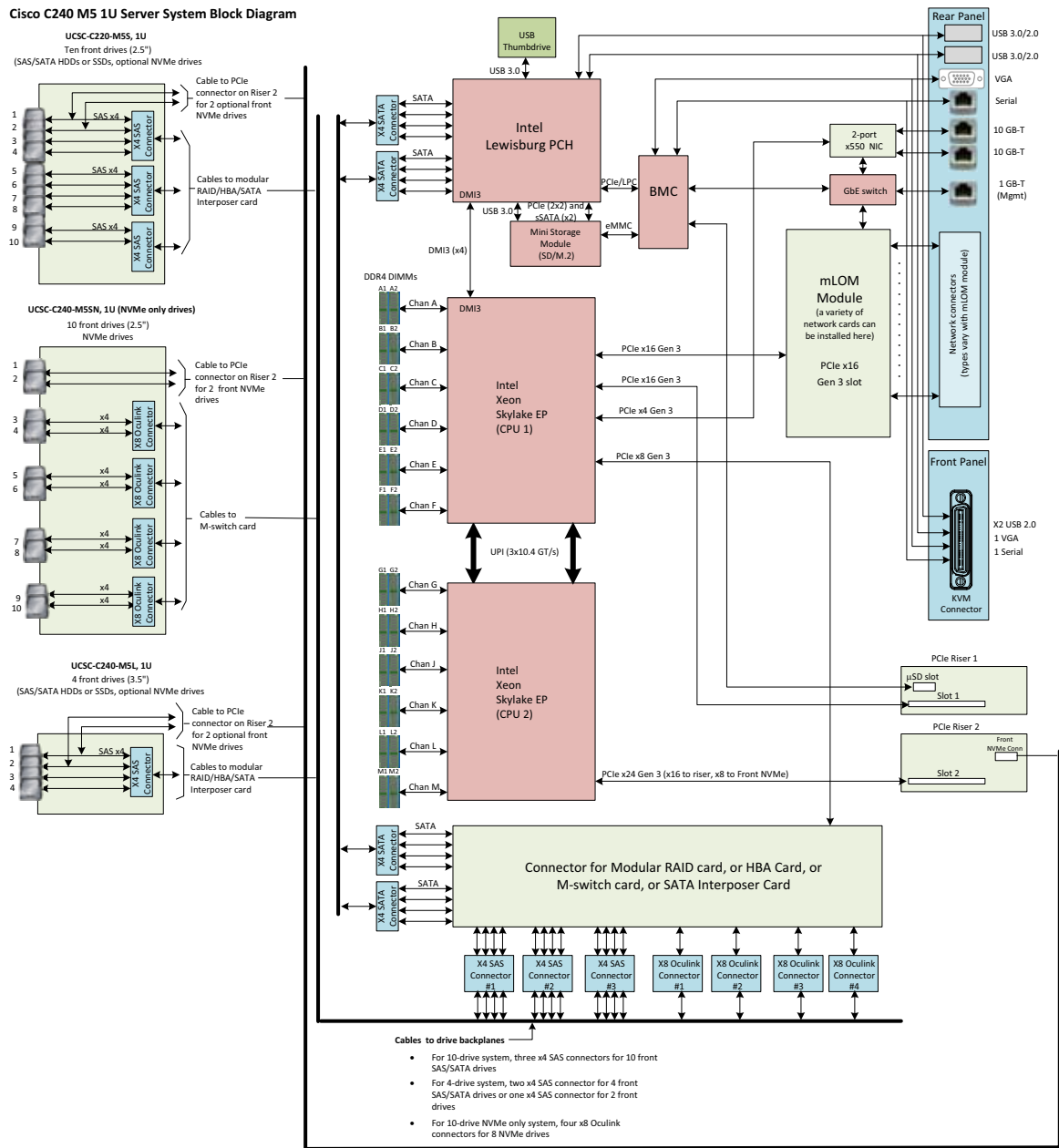

## RAID Option ROM (OPROM) Settings

The server contains an Option ROM (OPROM) for the PCIe slots. The server has a finite amount of option ROM with which it can boot up devices. Go into the BIOS and disable the OPROM on the PCIe slots not used for booting so that resources are available for the slots that are used for booting. An example OPROM BIOS screen is shown in *Figure 7*.

Figure 7 Example BIOS Screen for OPROM

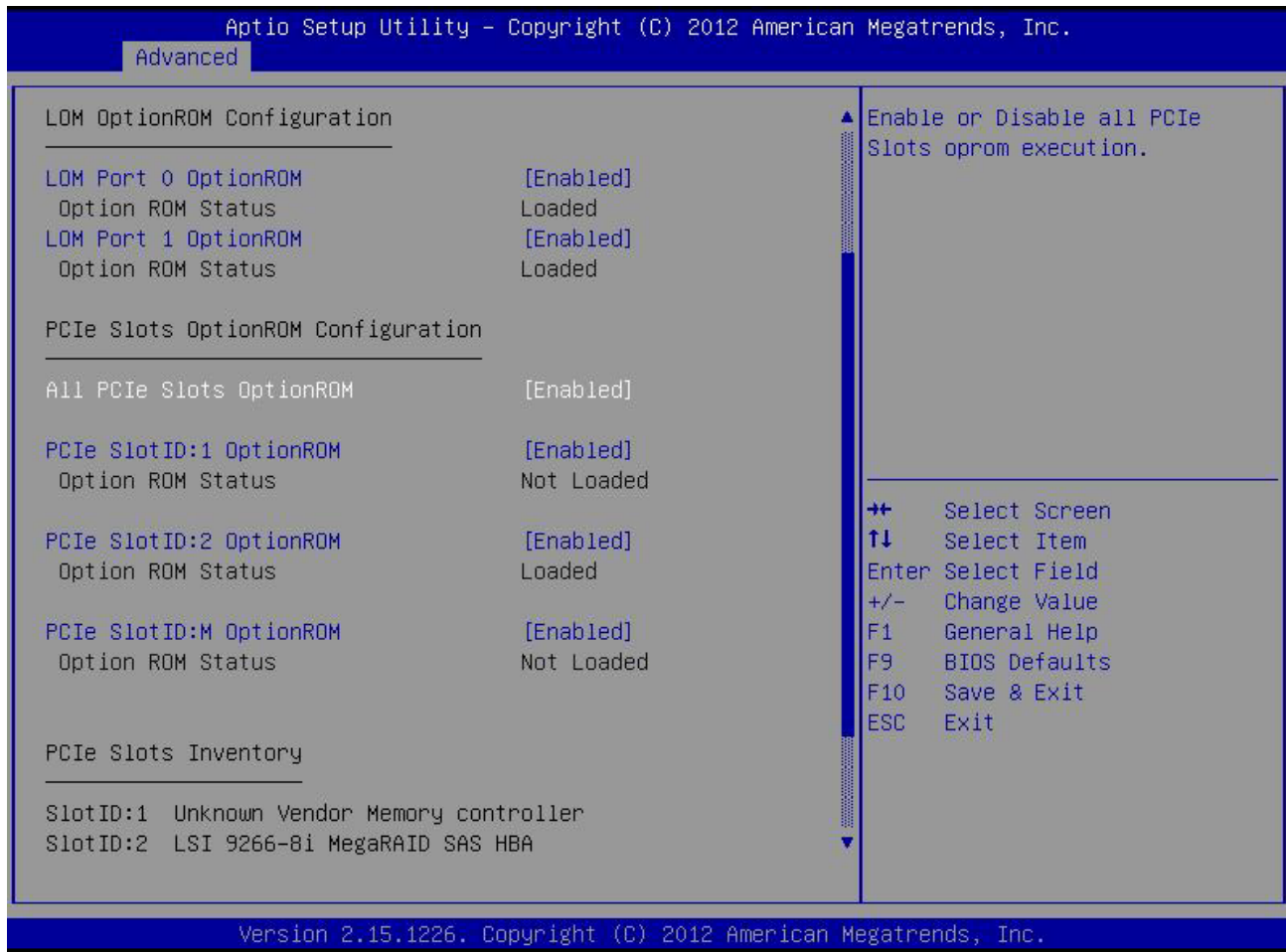

To Create a RAID Group

(1) While the server is booting, wait for the prompt and press function key F2 as shown in [Figure 8](#).

Figure 8 Function Key F2 Prompt



In a few seconds, you will see the screen that allows you to set up a RAID group for the primary SATA controller (see [Figure 9](#)).

Figure 9 Screen to Configure Primary SATA RAID Group

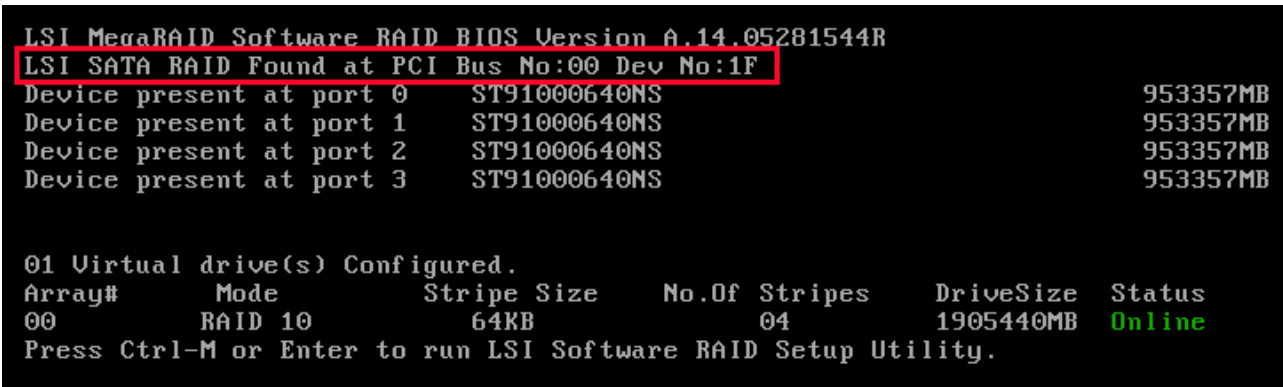

(2) Press Ctrl+M to start the RAID group creation process for the primary SATA controller (for drives 1-4, as shown in [Figure 9 on page 60](#)). Or, do nothing and wait for the next screen, which allows you to create a RAID group for the secondary SATA (sSATA) controller see [Figure 10](#).

Figure 10 Screen to Configure Secondary SATA (sSATA) RAID Group

```

Device present at port 3      ST91000640NS      953357MB

01 Virtual drive(s) Configured.
Array#      Mode      Stripe Size      No.Of Stripes      DriveSize      Status
00          RAID 10      64KB             04                 1905440MB      Online
Press Ctrl-M or Enter to run LSI Software RAID Setup Utility.

LSI MegaRAID Software RAID BIOS Version A.14.05281544R
LSI sSATA RAID Found at PCI Bus No:00 Dev No:11
Device present at port 0      INTEL SSDSC2BA200G3      190270MB
Device present at port 1      INTEL SSDSC2BA200G3      190270MB
Device present at port 2      INTEL SSDSC2BB120G4      113961MB
Device present at port 3      Micron_P400e-MTFDDAK100MAR      94884MB

04 Virtual drive(s) Configured.
Array#      Mode      Stripe Size      No.Of Stripes      DriveSize      Status
00          RAID 0      64KB             01                 189781MB      Online
01          RAID 0      64KB             01                 189781MB      Online
02          RAID 0      64KB             01                 113487MB      Online
03          RAID 0      64KB             01                 94413MB       Online
Press Ctrl-M or Enter to run LSI Software RAID Setup Utility.

```

(3) Press Ctrl+M to start the RAID group creation process for the secondary SATA (sSATA) controller (for drives 5-8, as shown in [Figure 7 on page 59](#)).

## Serial Port Details

The pinout details of the rear RJ-45 serial port connector are shown in *Figure 11*.

Figure 11 Serial Port (Female RJ-45 Connector) Pinout

### Serial Port (RJ-45 Female Connector)

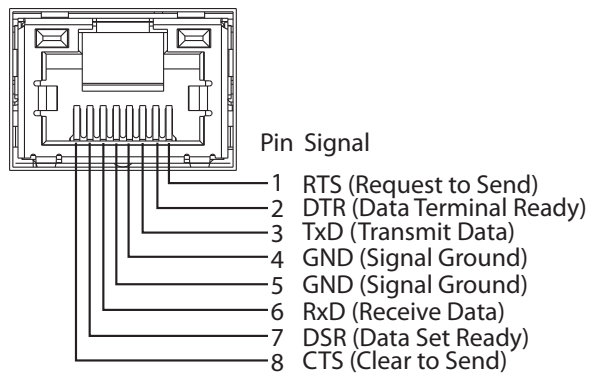

## Upgrade and Servicing-Related Parts

This section lists the upgrade and servicing-related parts you may need during the life of your server. Some of these parts are configured with every server, and some may be ordered when needed or may be ordered and kept on hand as spares for future use.

**Table 31 Upgrade and Servicing-related Parts for UCS C220 M5 SFF Server**

Spare Product ID (PID)	Description
UCSC-HS-C220M5=	Heat sink for UCS C220 M5 rack servers 150W CPUs & below
UCSC-HS2-C220M5=	Heat sink for UCS C220 M5 rack servers CPUs above 150W
UCS-CPUAT=	CPU Assembly Tool for M5 Servers
UCS-CPU-TIM=	CPU thermal interface material syringe for M5 server HS seal
UCSX-HSCK=	UCS Processor Heat Sink Cleaning Kit For Replacement of CPU
UCS-M5-CPU-CAR=	UCS M5 CPU Carrier
CBL-NVME-C220FF=	C220 M5L/M5S PCIe SSD cable (1) for SFF & LFF chassis
UCSC-SATA-KIT-M5=	C220 M5 (2) SATA/SW RAID cables, 1U riser & interposer, for up to 8-drives
UCSC-SATAIN-220M5=	C220 M5 (8-drive) SATA Interposer board
CBL-SC-MR12GM5=	Super Cap cable for UCSC-RAID-M5 for C220 M5 Servers
UCSC-XRAIDR-220M5=	Riser to support SATA, MRAID for C220 M5 servers
UCSC-BBLKD-S2=	C-Series M5 SFF drive blanking panel
UCSC-PCIF-01H=	PCIe Low Profile blanking panel for UCS C-Series Server
UCSC-PCIF-01F=	PCIe Full Height blanking panel for UCS C-Series Server
UCSC-MLOM-BLK=	MLOM Blanking Panel
UCSC-RAILF-M4=	Friction Rail Kit for C220 M4 rack servers
UCSC-CMAF-M4=	Reversible CMA for C220 M4 friction & ball bearing rail kits
UCSC-RAILB-M4=	Ball Bearing Rail Kit for C220 M4 and C240 M4 rack servers
UCSC-BZL-C220M5=	C220 M5 Security Bezel
UCSC-FAN-C220M5=	C220 M5 Fan Module (one)
N20-BKVM=	KVM cable for Server console port
UCSC-PSU-BLKP1U=	Power Supply Blanking Panel for C220 M5 and C240 M5 servers
UCS-MSTOR-SD=	Mini Storage Carrier for SD (holds up to 2)
UCS-MSTOR-M2=	Mini Storage Carrier for M.2 SATA/NVME (holds up to 2)



## RACKS

The Cisco R42612 rack is certified for Cisco UCS installation at customer sites and is suitable for the following equipment:

- Cisco UCS B-Series servers and fabric interconnects
- Cisco UCS C-Series and select Nexus switches

The rack is compatible with hardware designed for EIA-standard 19-inch racks. Cisco R42612 Rack. See Cisco RP-Series Rack and Rack PDU specification for more details at

<http://www.cisco.com/c/dam/en/us/products/collateral/servers-unified-computing/r-series-racks/rack-pdu-specsheet.pdf>

## PDU

Cisco RP Series Power Distribution Units (PDUs) offer power distribution with branch circuit protection.

Cisco RP Series PDU models distribute power to up to 42 outlets. The architecture organizes power distribution, simplifies cable management, and enables you to move, add, and change rack equipment without an electrician.

With a Cisco RP Series PDU in the rack, you can replace up to two dozen input power cords with just one. The fixed input cord connects to the power source from overhead or under-floor distribution. Your IT equipment is then powered by PDU outlets in the rack using short, easy-to-manage power cords.

The C-series servers accept the zero-rack-unit (ORU) or horizontal PDU. See Cisco RP-Series Rack and Rack PDU specification for more details at

<http://www.cisco.com/c/dam/en/us/products/collateral/servers-unified-computing/r-series-racks/rack-pdu-specsheet.pdf>

## KVM CABLE

The KVM cable provides a connection into the server, providing a DB9 serial connector, a VGA connector for a monitor, and dual USB ports for a keyboard and mouse. With this cable, you can create a direct connection to the operating system and the BIOS running on the server.

The KVM cable ordering information is listed in [Table 32](#).

Table 32 KVM Cable

Product ID (PID)	PID Description
N20-BKVM=	KVM cable for UCS Server console port

Figure 12 KVM Cable

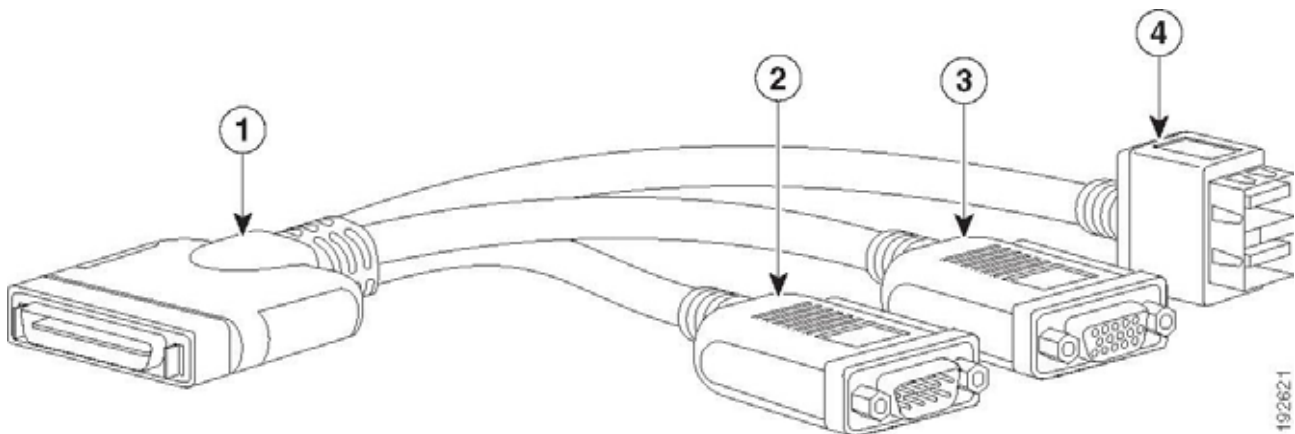

1	Connector (to server front panel)	3	VGA connector (for a monitor)
2	DB-9 serial connector	4	Two-port USB connector (for a mouse and keyboard)

## TECHNICAL SPECIFICATIONS

### Dimensions and Weight

Table 33 UCS C220 M5 Dimensions and Weight

Parameter	Value
Height	1.7 in. (4.32 cm)
Width	16.89 in. (43.0 cm)
Depth	including handles: 18.98 in. (48.2 cm)
	29.8 in. (75.6 cm)
	including handles: 30.98 in. (78.7 cm)
Front Clearance	3 in. (76 mm)
Side Clearance	1 in. (25 mm)
Rear Clearance	6 in. (152 mm)
Weight	
Maximum (8 HDDs, 2 CPUs, 16 DIMMs, two power supplies)	37.5 lbs (17.0 kg)
Minimum (1 HDD, 1 CPU, 1 DIMM, one power supply)	29.0 lbs (13.2 kg)
Bare (0 HDD, 0 CPU, 0 DIMM, one power supply)	26.7 lbs (12.1 kg)

## Power Specifications

The server is available with the following types of power supplies:

- 770 W (AC) power supply (see [Table 34](#)).
- 1050 W (AC) power supply (see [Table 35](#)).
- 1050 W V2 (DC) power supply (see [Table 36](#))

Table 34 UCS C220 M5 SFF Power Specifications (770 W AC power supply)

Parameter	Specification			
Input Connector	IEC320 C14			
Input Voltage Range (V rms)	100 to 240			
Maximum Allowable Input Voltage Range (V rms)	90 to 264			
Frequency Range (Hz)	50 to 60			
Maximum Allowable Frequency Range (Hz)	47 to 63			
Maximum Rated Output (W)	770			
Maximum Rated Standby Output (W)	36			
Nominal Input Voltage (V rms)	100	120	208	230
Nominal Input Current (A rms)	8.8	7.4	4.2	3.8
Maximum Input at Nominal Input Voltage (W)	855	855	855	846
Maximum Input at Nominal Input Voltage (VA)	882	882	882	872
Minimum Rated Efficiency (%) <sup>1</sup>	90	90	90	91
Minimum Rated Power Factor <sup>1</sup>	0.97	0.97	0.97	0.97
Maximum Inrush Current (A peak)	15			
Maximum Inrush Current (ms)	0.2			
Minimum Ride-Through Time (ms) <sup>2</sup>	12			

Notes:

1. This is the minimum rating required to achieve 80 PLUS Platinum certification, see test reports published at <http://www.80plus.org/> for certified values
2. Time output voltage remains within regulation limits at 100% load, during input voltage dropout

Table 35 UCS C220 M5 1050 W (AC) Power Supply Specifications

Parameter	Specification
Input Connector	IEC320 C14
Input Voltage Range (V rms)	100 to 240
Maximum Allowable Input Voltage Range (V rms)	90 to 264
Frequency Range (Hz)	50 to 60
Maximum Allowable Frequency Range (Hz)	47 to 63

**Table 35 UCS C220 M5 1050 W (AC) Power Supply Specifications**

	800		1050	
Maximum Rated Output (W) <sup>1</sup>				
Maximum Rated Standby Output (W)			36	
Nominal Input Voltage (V rms)	100	120	208	230
Nominal Input Current (A rms)	9.2	7.6	5.8	5.2
Maximum Input at Nominal Input Voltage (W)	889	889	1167	1154
Maximum Input at Nominal Input Voltage (VA)	916	916	1203	1190
Minimum Rated Efficiency (%) <sup>2</sup>	90	90	90	91
Minimum Rated Power Factor <sup>2</sup>	0.97	0.97	0.97	0.97
Maximum Inrush Current (A peak)			15	
Maximum Inrush Current (ms)			0.2	
Minimum Ride-Through Time (ms) <sup>3</sup>			12	

**Notes:**

1. Maximum rated output is limited to 800W when operating at low-line input voltage (100-127V)
2. This is the minimum rating required to achieve 80 PLUS Platinum certification, see test reports published at <http://www.80plus.org/> for certified values
3. Time output voltage remains within regulation limits at 100% load, during input voltage dropout

**Table 36 UCS C220 M5 1050 W (DC) Power Supply Specifications**

Parameter	Specification
Input Connector	Molex 42820
Input Voltage Range (V rms)	-48
Maximum Allowable Input Voltage Range (V rms)	-40 to -72
Frequency Range (Hz)	NA
Maximum Allowable Frequency Range (Hz)	NA
Maximum Rated Output (W)	1050
Maximum Rated Standby Output (W)	36
Nominal Input Voltage (V rms)	-48
Nominal Input Current (A rms)	24
Maximum Input at Nominal Input Voltage (W)	1154
Maximum Input at Nominal Input Voltage (VA)	1154
Minimum Rated Efficiency (%) <sup>1</sup>	91
Minimum Rated Power Factor <sup>1</sup>	NA
Maximum Inrush Current (A peak)	15
Maximum Inrush Current (ms)	0.2
Minimum Ride-Through Time (ms) <sup>2</sup>	5

**Notes:**

1. This is the minimum rating required to achieve 80 PLUS Platinum certification, see test reports published at <http://www.80plus.org/> for certified values

2. Time output voltage remains within regulation limits at 100% load, during input voltage dropout

For configuration-specific power specifications, use the Cisco UCS Power Calculator at this URL:

<http://ucspowercalc.cisco.com>

## Environmental Specifications

The environmental specifications for the C220 M5 server are listed in [Table 37](#).

Table 37 UCS C220 M5 SFF Environmental Specifications

Parameter	Minimum
Operating Temperature	10°C to 35°C (50°F to 95°F) with no direct sunlight Maximum allowable operating temperature de-rated 1°C/300 m (1°F/547 ft) above 950 m (3117 ft)
Extended Operating Temperature	5°C to 40°C (41°F to 104°F) with no direct sunlight Maximum allowable operating temperature de-rated 1°C/175 m (1°F/319 ft) above 950 m (3117 ft) 5°C to 45°C (41°F to 113°F) with no direct sunlight Maximum allowable operating temperature de-rated 1°C/125 m (1°F/228 ft) above 950 m (3117 ft) System performance may be impacted when operating in the extended operating temperature range. Operation above 40C is limited to less than 1% of annual operating hours. Hardware configuration limits apply to extended operating temperature range.
Non-Operating Temperature	-40°C to 65°C (-40°F to 149°F) Maximum rate of change (operating and non-operating) 20°C/hr (36°F/hr)
Operating Relative Humidity	8% to 90% and 24°C (75°F) maximum dew-point temperature, non-condensing environment
Non-Operating Relative Humidity	5% to 95% and 33°C (91°F) maximum dew-point temperature, non-condensing environment
Operating Altitude	0 m to 3050 m {10,000 ft)
Non-Operating Relative Humidity	5% to 95% and 33oC (91oF) maximum dew-point temperature, non-condensing environment
Sound Power level, Measure A-weighted per ISO7779 LWAd (Bels) Operation at 73°F (23°C)	5.8
Sound Pressure level, Measure A-weighted per ISO7779 LpAm (dBA) Operation at 73°F (23°C)	43



## Extended Operating Temperature Hardware Configuration Limits

Table 38 Cisco UCS C220 M5 Extended Operating Temperature Hardware Configuration Limits

Platform <sup>1</sup>	ASHRAE A3 (5°C to 40°C) <sup>2</sup>	ASHRAE A4 (5°C to 45°C) <sup>3</sup>
Processors:	155W+	155W+ and 105W+ (4 or 6 Cores)
Memory:	LRDIMMs	LRDIMMs
Storage:	M.2 SATA SSDs	M.2 SATA SSDs
	NVMe SSDs	NVMe SSDs
Peripherals:	PCIe NVMe SSDs	MRAID
	GPUs	PCIe NVMe SSDs
		GPUs
		mLOMs
		VICs
		NICs
		HBAs

**Notes:**

1. Two PSUs are required and PSU failure is not supported
2. Non-Cisco UCS qualified peripherals and/or peripherals that consume more than 25W are not supported
3. High power or maximum power fan control policy must be applied

## Compliance Requirements

The regulatory compliance requirements for C-Series servers are listed in [Table 39](#).

**Table 39 UCS C-Series Regulatory Compliance Requirements**

Parameter	Description
Regulatory Compliance	Products should comply with CE Markings per directives 2014/30/EU and 2014/35/EU
Safety	UL 60950-1 Second Edition CAN/CSA-C22.2 No. 60950-1 Second Edition EN 60950-1 Second Edition IEC 60950-1 Second Edition AS/NZS 60950-1 GB4943 2001
EMC - Emissions	47CFR Part 15 (CFR 47) Class A AS/NZS CISPR32 Class A CISPR32 Class A EN55032 Class A ICES003 Class A VCCI Class A EN61000-3-2 EN61000-3-3 KN32 Class A CNS13438 Class A
EMC - Immunity	EN55024 CISPR24 EN300386 KN35



---

**Americas Headquarters**  
Cisco Systems, Inc.  
San Jose, CA

**Asia Pacific Headquarters**  
Cisco Systems (USA) Pte. Ltd.  
Singapore

**Europe Headquarters**  
Cisco Systems International BV Amsterdam,  
The Netherlands

---

Cisco has more than 200 offices worldwide. Addresses, phone numbers, and fax numbers are listed on the Cisco Website at [www.cisco.com/go/offices](http://www.cisco.com/go/offices).

---

Cisco and the Cisco Logo are trademarks of Cisco Systems, Inc. and/or its affiliates in the U.S. and other countries. A listing of Cisco's trademarks can be found at [www.cisco.com/go/trademarks](http://www.cisco.com/go/trademarks). Third party trademarks mentioned are the property of their respective owners. The use of the word partner does not imply a partnership relationship between Cisco and any other company. (1005R)