





## **Cisco Unified IP Phone 7906G and 7911G Phone Guide for Cisco Unified Communications Manager 6.0 (SCCP and SIP)**

### **Americas Headquarters**

Cisco Systems, Inc.  
170 West Tasman Drive  
San Jose, CA 95134-1706  
USA  
<http://www.cisco.com>  
Tel: 408 526-4000  
800 553-NETS (6387)  
Fax: 408 527-0883



## Common Phone Tasks

View online help on the phone	Press  and choose <b>Help</b> .
Place a call	Go off-hook before or after dialing a number.
Redial a number	Press <b>Redial</b> .
Talk using the handset and listen on the speaker	(Group Listen mode only.) Press <b>GListen</b> .
Listen on the speaker only	(Monitor mode only.) Press <b>Monitor</b> .
Use your call logs	Press  and select <b>Directories &gt; Missed Calls, Placed Calls, or Received Calls</b> . Select a number and press <b>Dial</b> .
Edit a number	Press <b>EditDial</b> , << or >>.
Hold/resume a call	Highlight a call to put on hold or resume from hold, and press  .
Transfer a call to a new number	Press <b>Transfer</b> , enter the number, then press <b>Transfer</b> again.
Start a standard (ad hoc) conference call	Press <b>more &gt; Confrn</b> and dial the participant, then press <b>Confrn</b> again.



Cisco, Cisco Systems, and the Cisco Systems logo are registered trademarks or trademarks of Cisco Systems, Inc. and/or its affiliates in the United States and certain other countries. All other trademarks mentioned in this document or Website are the property of their respective owners. The use of the word partner does not imply a partnership relationship between Cisco and any other company. (0610R)

© 2007 Cisco Systems, Inc. All rights reserved.

OL-12474-01



### QUICK REFERENCE



## Cisco Unified IP Phone 7906G and 7911G for Cisco Unified Communications Manager 6.0 (SCCP and SIP)

Softkey Definitions  
 Phone Screen Icons  
 Button Icons  
 Speed Dialing  
 Common Phone Tasks

















## Softkey Definitions





<b>AbbrDial</b>	Dial using a speed-dial index number
<b>Answer</b>	Answer a call
<b>Barge</b>	Add yourself to a call on a shared line
<b>CallBack</b>	Receive notification when a busy extension becomes available
<b>Cancel</b>	Cancel an action or exit a screen without applying changes
<b>cBarge</b>	Add yourself to a call on a shared line and establish a conference
<b>CFwdALL</b>	Setup/cancel call forwarding
<b>Clear</b>	Delete records or settings
<b>Close</b>	Close the current window
<b>ConfList</b>	View conference participants
<b>Confrn</b>	Create a conference call
<b>Delete</b>	Remove characters to the right of the cursor when using <b>EditDial</b>
<b>Details (SCCP only)</b>	Opens the Details call record for a multiparty call in the Missed Calls and Received Calls logs
<b>Dial</b>	Dial a phone number
<b>DirTrfr (SCCP only)</b>	Transfer two calls to each other
<b>DND</b>	Turn on/off Do Not Disturb (DND)
<b>EditDial</b>	Edit a number in a call log
<b>EndCall</b>	Disconnect the current call
<b>Erase</b>	Reset settings to their defaults
<b>Exit</b>	Return to the previous screen

<b>GListen</b>	Talk using the handset and listen on the speaker (Group Listen)
<b>GLOff</b>	Disable Group Listen
<b>GPickUp</b>	Answer a call ringing in another group
<b>iDivert</b>	Send or redirect a call to a voice message system
<b>Join (SCCP only)</b>	Join several calls on a single line to create a conference
<b>MeetMe</b>	Host a Meet-Me conference call
<b>Monitor</b>	Listen to a call on the speaker
<b>MonOff</b>	Disable the Monitor function
<b>more</b>	Display additional softkeys
<b>Msgs</b>	Access voice mail system
<b>New Call</b>	Make a new call
<b>OPickUp</b>	Answer a call ringing in an associated group
<b>Park</b>	Store a call using Call Park
<b>PickUp</b>	Answer a call in your group
<b>QRT</b>	Submit call problems to the system administrator
<b>Redial</b>	Redial the most recently dialed number
<b>Remove</b>	Remove a conference participant
<b>RMLstC</b>	Drop the last party added to a conference call
<b>Search</b>	Search for a directory listing
<b>Transfer</b>	Transfer a call
<b>Update</b>	Refresh content
<b>VidMode (SCCP only)</b>	Choose a video display mode





<<	Delete entered characters
>>	Move through entered characters

## Phone Screen Icons



Line and Call Status	
	Call Forwarding enabled
	Call on hold
	Connected call
	Off-hook
	On-hook
	Incoming call
	Shared line in use
	Authenticated call
	Encrypted call
	Priority call
	Medium priority call
	High priority call
	Highest priority call
Other Features	
	Speed Dial configured
	Message waiting
	Option selected

	Feature enabled
	URL entry in call log is ready to edit (SIP only)
Audio or Video Mode	
	Handset in use
	Speaker in use (Monitor on)
	Video enabled (Cisco Unified IP Phone 7911G only with SCCP)

## Button Icons

	Volume
	Navigation
	Hold
	Applications Menu

## Speed Dialing

If you want to...	Then...
Speed dial a number	<ul style="list-style-type: none"> <li>Press  and select a number to dial.</li> <li>Press  and choose <b>Directories &gt; Speed Dials</b>. Select a number to dial.</li> <li>Enter a speed-dial number while on-hook and press <b>AbbrDial</b>.</li> </ul>

# Contents

---

## **Getting Started 1**

- Using this Guide 1
- Finding Additional Information 2
- Safety and Performance Information 2
- Cisco Product Security Overview 3
- Accessibility Features 3

## **Connecting Your Phone 4**

### **An Overview of Your Phone 8**

- Understanding Buttons and Hardware 8
- Understanding Lines vs. Calls 10
  - Understanding Line and Call Icons 10
- Accessing Applications Menus 10
- Accessing the Help System on Your Phone 11
- Understanding Feature Availability 11
- Understanding SIP vs. SCCP 11

### **Basic Call Handling 12**

- Placing a Call—Basic Options 12
- Placing a Call—Additional Options 13
- Answering a Call 14
- Ending a Call 15
- Using Hold and Resume 16
- Switching Between Multiple Calls 17
- Switching an In-Progress Call to Another Phone 17
- Viewing Multiple Calls 17

Transferring Calls	18
Sending a Call to a Voice Message System	19
Forwarding All Calls to Another Number	20
Using Do Not Disturb	20
Making Conference Calls	21
Understanding Types of Conference Calls	21
Starting and Joining a Standard Conference	22
Starting or Joining a Meet-Me Conference Call	24
<b>Advanced Call Handling</b>	<b>25</b>
Speed Dialing	25
Picking Up a Redirected Call on Your Phone	26
Storing and Retrieving Parked Calls	27
Logging Out of Hunt Groups	27
Using a Shared Line	28
Understanding Shared Lines	28
Adding Yourself to a Shared-Line Call	29
Preventing Others from Viewing or Barging a Shared-Line Call	30
Making and Receiving Secure Calls	30
Tracing Suspicious Calls	31
Prioritizing Critical Calls	32
Using Cisco Extension Mobility	33
Managing Business Calls Using a Single Phone Number	34
<b>Using a Handset, Headset, and Speaker</b>	<b>36</b>
Using the Group Listen Feature	36
Using the Monitor Feature	37
Using and Obtaining a Headset	38
Using AutoAnswer	38
<b>Changing Phone Settings</b>	<b>39</b>
Customizing Rings and Message Indicators	39
Customizing the Phone Screen	40

## **Using Call Logs and Directories 41**

Using Call Logs 41

Directory Dialing 43

Using Corporate Directory on Your Phone 43

Using Personal Directory on Your Phone 44

## **Accessing Voice Messages 47**

### **Using the User Options Web Pages 48**

Accessing Your User Options Web Pages 48

Configuring Features and Services on the Web 49

Using Personal Directory on the Web 49

Using Your Personal Address Book on the Web 49

Configuring Fast Dials on the Web 50

Using the Address Book Synchronization Tool 51

Setting Up Speed Dials on the Web 51

Setting Up Phone Services on the Web 52

Controlling User Settings on the Web 53

Controlling Line Settings on the Web 54

Using Cisco WebDialer 55

Setting Up Phones and Access Lists for Mobile Connect 57

## **Understanding Additional Configuration Options 60**

### **Troubleshooting Your Phone 61**

General Troubleshooting 61

Viewing Phone Administration Data 62

Using the Quality Reporting Tool 62

## **Cisco One-Year Limited Hardware Warranty Terms 63**

## **Index 65**





# Getting Started

---

## Using this Guide

This guide provides you with an overview of the features available on your phone. You can read it completely for a solid understanding of your phone's capabilities, or refer to the table below for pointers to commonly-used sections.

<b>If you want to...</b>	<b>Then...</b>
Explore your phone on your own	Press  and choose <b>Help</b> .
Review safety information	See <a href="#">Safety and Performance Information</a> , page 2.
Connect your phone	See <a href="#">Connecting Your Phone</a> , page 4.
Use your phone after it is installed	Start with <a href="#">An Overview of Your Phone</a> , page 8.
Learn about the phone buttons	See <a href="#">Understanding Buttons and Hardware</a> , page 8.
Make calls	See <a href="#">Placing a Call—Basic Options</a> , page 12.
Put calls on hold	See <a href="#">Using Hold and Resume</a> , page 16.
Transfer calls	See <a href="#">Transferring Calls</a> , page 18.
Make conference calls	See <a href="#">Making Conference Calls</a> , page 21.
Set up speed dialing	See <a href="#">Speed Dialing</a> , page 25.
Share a phone number	See <a href="#">Using a Shared Line</a> , page 28.
Use the speaker on the phone	See <a href="#">Using a Handset, Headset, and Speaker</a> , page 36.
Change the ring volume or tone	See <a href="#">Changing Phone Settings</a> , page 39.
View your missed calls	See <a href="#">Using Call Logs and Directories</a> , page 41.
Listen to your voice messages	See <a href="#">Accessing Voice Messages</a> , page 47.
See softkey and icon definitions	Refer to the Quick Reference Card in the front of this guide.

## Finding Additional Information

You can access the most current Cisco documentation on the World Wide Web at this URL:

[http://www.cisco.com/en/US/products/hw/phones/ps379/tsd\\_products\\_support\\_series\\_home.htm](http://www.cisco.com/en/US/products/hw/phones/ps379/tsd_products_support_series_home.htm)

You can access the Cisco website at this URL:

<http://www.cisco.com/>

International Cisco websites can be accessed from this URL:

[http://www.cisco.com/public/countries\\_languages.shtml](http://www.cisco.com/public/countries_languages.shtml)

## Safety and Performance Information

Refer to these sections for information about the impact of power outages and other devices on your Cisco Unified IP Phone.

### Power Outage

Your accessibility to emergency service through the phone is dependent on the phone being powered. If there is an interruption in the power supply, Service and Emergency Calling Service dialing will not function until power is restored. In the case of a power failure or disruption, you may need to reset or reconfigure equipment before using the Service or Emergency Calling Service dialing.

### Using External Devices

The following information applies when you use external devices with the Cisco Unified IP Phone:

Cisco recommends the use of good quality external devices (headsets) that are shielded against unwanted radio frequency (RF) and audio frequency (AF) signals.

Depending on the quality of these devices and their proximity to other devices such as mobile phones or two-way radios, some audio noise may still occur. In these cases, Cisco recommends that you take one or more of the following actions:

- Move the external device away from the source of the RF or AF signals.
- Route the external device cables away from the source of the RF or AF signals.
- Use shielded cables for the external device, or use cables with a better shield and connector.
- Shorten the length of the external device cable.
- Apply ferrites or other such devices on the cables for the external device.

Cisco cannot guarantee the performance of the system because Cisco has no control over the quality of external devices, cables, and connectors. The system will perform adequately when suitable devices are attached using good quality cables and connectors.

**Caution**

---

In European Union countries, use only headsets that are fully compliant with the EMC Directive [89/336/EC].

---

## Cisco Product Security Overview

This product contains cryptographic features and is subject to United States and local country laws governing import, export, transfer and use. Delivery of Cisco cryptographic products does not imply third-party authority to import, export, distribute or use encryption. Importers, exporters, distributors and users are responsible for compliance with U.S. and local country laws. By using this product you agree to comply with applicable laws and regulations. If you are unable to comply with U.S. and local laws, return this product immediately.

A summary of U.S. laws governing Cisco cryptographic products may be found at: <http://www.cisco.com/wwl/export/crypto/tool/stqrg.html>. If you require further assistance please contact us by sending email to [export@cisco.com](mailto:export@cisco.com).

## Accessibility Features

A list of accessibility features is available upon request.

# Connecting Your Phone

Your system administrator will likely connect your new Cisco Unified IP Phone to the corporate IP telephony network. If that is not the case, refer to the graphics below to connect your phone.

The following graphic and table show how to connect the Cisco Unified IP Phone 7906G:

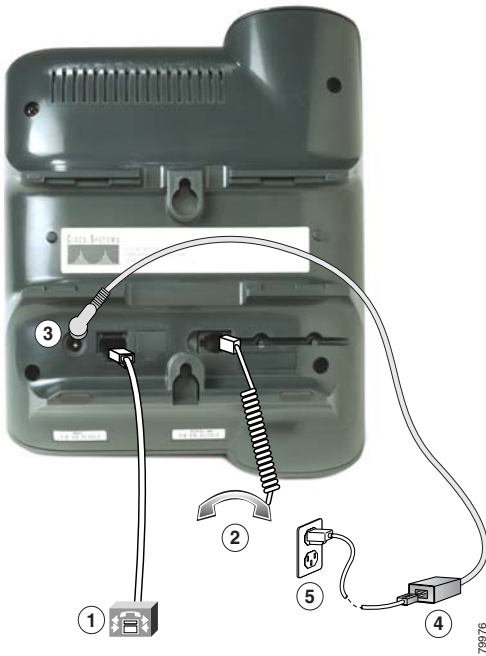

<b>1</b>	Network port (10/100 SW)	<b>4</b>	AC-to-DC power supply
<b>2</b>	Handset port	<b>5</b>	AC power cord
<b>3</b>	DC adapter port (DC48V)		

The following graphic and table show how to connect the Cisco Unified IP Phone 7911G:

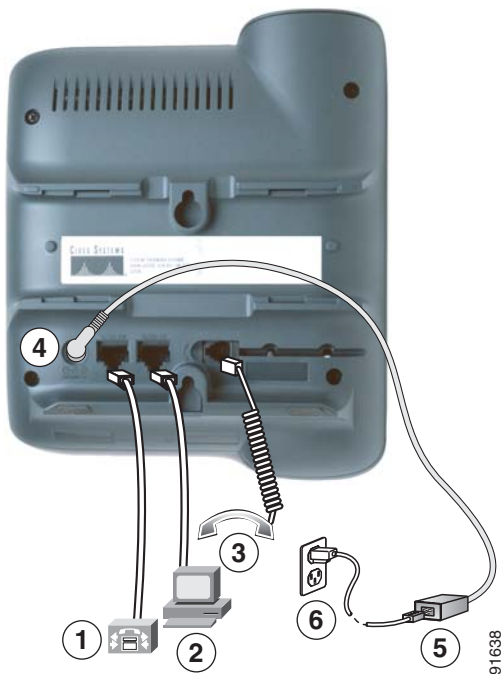

<b>1</b>	Network port (10/100 SW)	<b>4</b>	DC adapter port (DC48V)
<b>2</b>	Access port (10/100 PC)	<b>5</b>	AC-to-DC power supply
<b>3</b>	Handset port	<b>6</b>	AC power cord

## Adjusting the Handset Rest

When you connect your phone, you might want to adjust the handset rest to ensure that the receiver will not slip out of the cradle. See the table below for instructions.

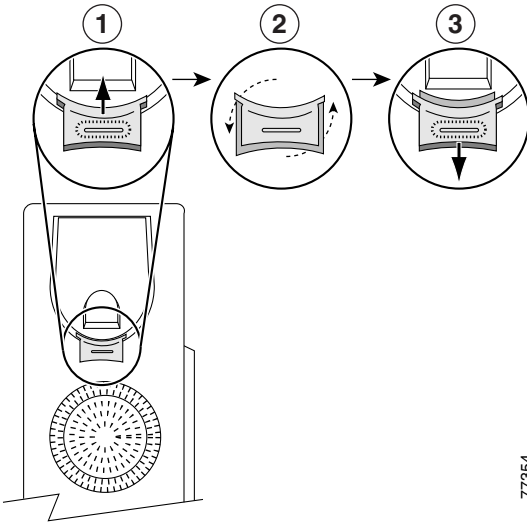

77354

1	Set the handset aside and pull the square plastic tab from the handset rest.
2	Rotate the tab 180 degrees.
3	Slide the tab back into the handset rest. An extension protrudes from the top of the rotated tab. Return the handset to the handset rest.

## Registering with TAPS

After your phone is connected to the network, your system administrator might ask you to auto-register your phone using the Tool for Auto-Registered Phones Support (TAPS). TAPS might be used either for a new phone or to replace an existing phone.

To register with TAPS, pick up the handset, enter the TAPS extension provided by your system administrator, and follow the voice prompts. You might need to enter your entire extension, including the area code. After your phone displays a confirmation message, hang up. The phone will restart.

## Headset Information

To use a headset, make sure the handset is disconnected, then connect the headset to the Handset port on the back of your phone.

Depending on headset manufacturer's recommendations, an external amplifier may be required. Refer to headset manufacturer's product documentation for more information.

Although Cisco Systems performs some internal testing of third-party headsets for use with the Cisco Unified IP Phones, Cisco does not certify or support products from headset or handset vendors. Because of the inherent environmental and hardware inconsistencies in the locations where Cisco Unified IP Phones are deployed, there is not a single “best” solution that is optimal for all environments. Cisco recommends that customers test the headsets that work best in their environment before deploying a large number of units in their network.

In some instances, the mechanics or electronics of various headsets can cause remote parties to hear an echo of their own voice when they speak to Cisco Unified IP Phone users.

Cisco Systems recommends the use of good quality external devices (headsets) that are screened against unwanted radio frequency (RF) and audio frequency (AF) signals. Depending on the quality of these devices and their proximity to other devices such as cell phones and two-way radios, some audio noise may still occur.

The primary reason that support of a headset would be inappropriate for the Cisco Unified IP Phone is the potential for an audible hum. This hum can either be heard by the remote party or by both the remote party and you, the Cisco Unified IP Phone user. Some potential humming or buzzing sounds can be caused by a range of outside sources, for example, electric lights, being near electric motors, large PC monitors. In some cases, a hum experienced by a user may be reduced or eliminated by using a local power cube or power injector.

#### **Audio Quality Subjective to the User**

Beyond the physical, mechanical and technical performance, the audio portion of a headset must sound good to you (the user) and to the party on the far end. Sound is subjective and Cisco cannot guarantee the performance of any headsets or handsets, but some of the headsets and handsets on the sites listed below have been reported to perform well with Cisco Unified IP Phones.

Nevertheless, it is ultimately still the customer’s responsibility to test this equipment in their own environment to determine suitable performance.

For information about headsets, see:

<http://www.vxicorp.com/cisco>

<http://www.plantronics.com>

<http://www.jabra.com>

# An Overview of Your Phone

---

Cisco Unified IP Phone 7906G and 7911G are full-feature telephones that provide voice communication over the same data network that your computer uses, allowing you to place and receive calls, put calls on hold, transfer calls, make conference calls, and so on.

In addition to basic call-handling features, your Cisco Unified IP Phone 7906G and 7911G can provide specialized or advanced telephony features that extend your call-handling capabilities. Depending on configuration, your phone supports:



- Access to network data, XML applications, and web-based services.
- Online customizing of phone features and services from your User Options web pages.

## Understanding Buttons and Hardware

You can use this graphic below to identify the buttons and hardware on your phone.



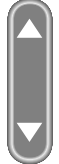

	Item	Description	For more information, see...
1	Phone screen	Displays phone menus and call activity including caller ID, call duration, and call state.	<a href="#">Accessing Applications Menus, page 10</a> and <a href="#">Understanding Feature Availability, page 11.</a>
2	Cisco Unified IP Phone series	Indicates your Cisco Unified IP Phone model series.	—
3	Softkey buttons	Each activates a softkey option displayed on your phone screen.	<a href="#">Softkey Definitions, page 3.</a>
4	Navigation button 	Allows you to scroll through menu items and highlight items. When the phone is on-hook, displays your Speed Dials.	<a href="#">Accessing Applications Menus, page 10</a> and <a href="#">Speed Dialing, page 25.</a>
5	Applications Menu button 	Displays the Applications menu that provides access to a voice message system, phone logs and directories, settings, services, and help.	<a href="#">Accessing Applications Menus, page 10.</a>
6	Hold button 	Places the active call on hold, resumes a call on hold, and switches between an active call and a call on hold.	<a href="#">Using Hold and Resume, page 16.</a>
7	Keypad	Allows you to dial phone numbers, enter letters, and choose menu items.	<a href="#">Basic Call Handling, page 12.</a>
8	Volume button 	Controls the handset, headset, speaker, and ringer volume.	<a href="#">Using a Handset, Headset, and Speaker, page 36.</a>
9	Handset with light strip	The light strip on the handset indicates an incoming call or new voice message.	<a href="#">Accessing Voice Messages, page 47.</a>
10	Footstand	Allows the phone to stand at a convenient angle on a desk or table.	—









## Understanding Lines vs. Calls

To avoid confusion about lines and calls, refer to these descriptions:

- Lines—Each line corresponds to a phone number (or extension) that others can use to call you. Your phone can support one line.
- Calls—Each line can support multiple calls. By default, your phone supports up to six connected calls, but your system administrator can adjust this number according to your needs. Only one call can be active at any time; other calls are automatically placed on hold.



## Understanding Line and Call Icons



Your phone displays icons to help you determine the call and line state (on-hook, on hold, ringing, connected, and so on).

Icon	Call or line state	Description
	On-hook line	No call activity on this line.
	Off-hook line	You are dialing a number or an outgoing call is ringing.
	Connected call	You are connected to the other party.
	Ringing call	A call is ringing on your line.
	Call on hold	You have put this call on hold. See <a href="#">Using Hold and Resume, page 16</a> .
	Remote-in-use	Another phone that shares your line has a connected call. See <a href="#">Understanding Shared Lines, page 28</a> .
	Reverting call	A holding call is reverting to your phone. See <a href="#">Using Hold and Resume, page 16</a> .
	Authenticated call	See <a href="#">Making and Receiving Secure Calls, page 30</a> .
	Encrypted call	See <a href="#">Making and Receiving Secure Calls, page 30</a> .





## Accessing Applications Menus

Use the Applications menus to access phone features.

If you want to...	Then...
Access the Applications menus	Press  to display a list of Applications: Messages, Directory, Settings, Services, and Help.
Scroll through a list or menu	Press  .

If you want to...	Then...
Select a menu item	Press  to highlight a menu item, then press <b>Select</b> .  You can also press the number on the keypad that corresponds to the number for the menu item.
Go back one level in a menu	Press <b>Exit</b> . (Note that if you press <b>Exit</b> from the top-level of a menu, the menu will close.)
Close a menu (and return to the Applications menu)	Press <b>Exit</b> one or more times until the menu closes, or press  .
Exit the Applications menu	Press  or <b>Exit</b> .

**Note**

After you press , the LED turns green and stays lit while you are using the Applications menus. If you depart from an application without pressing  or **Exit** (for example, to answer a new call), the phone screen display may change but the  button stays green. If you press  again, the application that you were using resumes at the point when it was interrupted.

## Accessing the Help System on Your Phone

The Cisco Unified IP Phone 7906G and 7911G provide a comprehensive online help system. To view the phone help, press  and choose **Help**.

## Understanding Feature Availability

Depending on your phone system configuration, features included in this Phone Guide might not be available to you or might work differently on your phone. Contact your support desk or system administrator for information about feature operation or availability.

## Understanding SIP vs. SCCP

Your phone can be configured to work with one of two signaling protocols: SIP (Session Initiation Protocol) or SCCP (Skinny Call Control Protocol). Your system administrator determines this configuration.

Phone features can vary depending on the protocol. This Phone Guide indicates which features are protocol-specific. To learn which protocol your phone is using, you can ask your system administrator or you can choose  > **Model Information** > **Call Control Protocol** on your phone.

# Basic Call Handling

You can perform basic call-handling tasks using a range of features and services. Feature availability can vary; see your system administrator for more information.

## Placing a Call—Basic Options

Here are some easy ways to place a call on your Cisco Unified IP Phone.





If you want to...	Then...	For more information, see...
Place a call	Pick up the handset and dial the number.	<a href="#">An Overview of Your Phone, page 8.</a>
Dial on-hook (with dial tone)	Press <b>New Call</b> and dial the number.	—
Redial a number	Press <b>Redial</b> .	—
Place a call when another call is active	<ol style="list-style-type: none"><li>1. Press <b>⊙</b>.</li><li>2. Press <b>New Call</b>.</li><li>3. Enter a number.</li></ol>	<a href="#">Using Hold and Resume, page 16.</a>
Dial from a call log	<ol style="list-style-type: none"><li>1. Press <b>⊕</b> and select <b>Directories &gt; Missed Calls, Received Calls, or Placed Calls</b>.</li><li>2. Scroll to the number and press <b>Dial</b>.</li></ol>	<a href="#">Using Call Logs, page 41.</a>

### Tips

- You can dial on-hook without a dial tone (pre-dial). To pre-dial, enter a number, then go off-hook by lifting the handset and press **Dial**.
- When you pre-dial, your phone tries to anticipate the number you are dialing by displaying matching numbers (if available) from your Placed Calls log. This is called Auto Dial. To call a number displayed with Auto Dial, scroll to it, press **Dial**, and go off-hook.
- If you make a mistake while dialing, press **<<** to erase digits.
- If parties on a call hear a beep tone, the call might be monitored or recorded. Ask your system administrator for more information.

## Placing a Call—Additional Options

You can place calls using special features and services that might be available on your phone. See your system administrator for more information about these additional options.

If you want to...	Then...	For more information, see...
Speed dial a number	Do one of the following: <ul style="list-style-type: none"> <li>• Press , choose a speed-dial number, and press <b>Dial</b>.</li> <li>• Press  and select <b>Directories &gt; Speed Dials</b>. Select a number and press <b>Dial</b>.</li> <li>• Use the Abbreviated Dial feature.</li> <li>• Use the Fast Dial feature.</li> </ul>	<a href="#">Speed Dialing, page 25.</a>
Dial from a corporate directory on your phone	<ol style="list-style-type: none"> <li>1. Press  and select <b>Directories &gt; Corporate Directory</b> (name can vary).</li> <li>2. Enter a name and press <b>Search</b>.</li> <li>3. Highlight a listing and go off-hook.</li> </ol>	<a href="#">Using Call Logs, page 41.</a>
Dial from a corporate directory on your personal computer using Cisco WebDialer	<ol style="list-style-type: none"> <li>1. Open a web browser and go to a WebDialer-enabled corporate directory.</li> <li>2. Click the number that you want to dial.</li> </ol>	<a href="#">Using Cisco WebDialer, page 55.</a>
Use Cisco CallBack to receive notification when a busy or ringing extension is available	<ol style="list-style-type: none"> <li>1. Press <b>CallBack</b> while listening to the busy tone or ring sound.</li> <li>2. Hang up. Your phone alerts you when the line is free.</li> <li>3. Place the call again.</li> </ol>	Your system administrator.
Make a priority (precedence) call (SCCP phones only)	Enter the Multilevel Precedence and Preemption (MLPP) access number, then enter a phone number.	<a href="#">Prioritizing Critical Calls, page 32.</a>
Dial from a Personal Address Book (PAB) entry	<ol style="list-style-type: none"> <li>1. Press  and select <b>Directories &gt; Personal Directory</b> to log in.</li> <li>2. Choose <b>Personal Address Book</b> and search for a listing.</li> </ol>	<a href="#">Using the User Options Web Pages, page 48.</a> <a href="#">Using Personal Directory on Your Phone, page 44.</a>

<b>If you want to...</b>	<b>Then...</b>	<b>For more information, see...</b>
Place a call using a billing or tracking code (SCCP phones only)	<ol style="list-style-type: none"> <li>1. Dial a number.</li> <li>2. After the tone, enter a client matter code (CMC) or a forced authorization code (FAC).</li> </ol>	Your system administrator.
Place a call using your Cisco Extension Mobility profile	Log in to the Cisco Extension Mobility service on a phone.	<a href="#">Using Cisco Extension Mobility, page 33.</a>
Make a call from a cellular phone using Mobile Voice Access	<ol style="list-style-type: none"> <li>1. Dial your assigned Mobile Voice access number.</li> <li>2. Enter your cellular phone number (if requested) and PIN.</li> <li>3. Press 1 to make a call to an enterprise IP phone.</li> <li>4. Dial a desktop phone number other than your desktop phone number.</li> </ol>	<a href="#">Managing Business Calls Using a Single Phone Number, page 34.</a>

## Tip

Obtain this information from your system administrator before using Mobile Voice Access to make a call:

- Mobile Voice Access number
- End user PIN

## Answering a Call

You can answer a call by simply lifting the handset, or you can use other options if they are available on your phone.

<b>If you want to...</b>	<b>Then...</b>	<b>For more information, see...</b>
Switch from a connected call to answer a new call	Press <b>Answer</b> .	<a href="#">Using Hold and Resume, page 16.</a>
Answer a call using call waiting	Press <b>Answer</b> .	<a href="#">Using Hold and Resume, page 16.</a>
Send a call to a voice message system	Press <b>iDivert</b> .	<a href="#">Sending a Call to a Voice Message System, page 19.</a>
Automatically connect incoming calls	Use <b>AutoAnswer</b> .	<a href="#">Using AutoAnswer, page 38.</a>

If you want to...	Then...	For more information, see...
Retrieve a parked call on another phone	Use Call Park or Directed Call Park.	<a href="#">Storing and Retrieving Parked Calls, page 27.</a>
Use your phone to answer a call ringing elsewhere	Use Call Pickup.	<a href="#">Picking Up a Redirected Call on Your Phone, page 26.</a>
Answer a priority call (SCCP phones only)	Hang up the current call and press <b>Answer</b> .	<a href="#">Prioritizing Critical Calls, page 32.</a>
Answer a call on your cellular phone or other remote destination	Set up Mobile Connect and answer your phone. When you enable Mobile Connect: <ul style="list-style-type: none"> <li>• Your desktop and remote destinations receive calls simultaneously.</li> <li>• When you answer the call on your desktop phone, the remote destinations stop ringing, are disconnected, and display a missed call message.</li> <li>• When you answer the call on one remote destination, the other remote destinations stop ringing, are disconnected, and a missed call message is shown on the other remote destinations.</li> </ul>	<a href="#">Managing Business Calls Using a Single Phone Number, page 34.</a>

### Tip



If parties on a call hear a beep tone, the call might be monitored or recorded. Ask your system administrator for more information.

## Ending a Call

To end a call, simply hang up. Here are some more details.

If you want to...	Then...
Hang up while using the handset	Return the handset to its cradle. Or press <b>EndCall</b> .
Hang up while monitoring a call (using the speaker)	Press <b>EndCall</b> .
Hang up one call, but preserve another call on the same line	Press <b>EndCall</b> . If necessary, remove the call from hold first.



# Using Hold and Resume

You can hold and resume calls. When you put a call on hold, the Hold icon  appears next to the caller ID and the Hold button  becomes lit (red).

If the Hold Reversion feature is enabled for your phone, calls that you leave on hold will revert back to ringing on your phone after a certain length of time. These “reverting” calls remain on hold until you resume them.

Your phone indicates the presence of a reverting call by:

- Alerting you at intervals with a single ring (or flash or beep, depending on your phone line setting).
- Briefly displaying a “Hold Reversion” message in the status bar at the bottom of the phone screen.
- Displaying the animated Hold Reversion icon  next to the caller ID for the held call.

If you want to...	Then...
Put a call on hold	<ol style="list-style-type: none"><li>1. Make sure the call you want to put on hold is highlighted.</li><li>2. Press .</li></ol>
Remove a call from hold	<ol style="list-style-type: none"><li>1. Make sure the appropriate call is highlighted.</li><li>2. Press .</li></ol>

## Tips

- Engaging the Hold feature typically generates music or a beeping tone.
- When a held call is highlighted, the Hold button  becomes lit (red). When a call that is not held is highlighted, and there are other held calls on the line, the Hold button changes to blinking (red).
- If you receive an alert for an incoming call and a reverting call at the same time, by default your phone will shift the focus of the phone screen to display the incoming call. Your system administrator can change this focus priority setting.
- If you use a shared line, Hold Reversion rings only on the phone that put the call on hold, not on the other phones that share the line.
- The duration between Hold Reversion alerts is determined by your system administrator.



## Switching Between Multiple Calls

You can switch between multiple calls on your phone.

If you want to...	Then...
Switch between connected calls	<ol style="list-style-type: none"> <li>1. Make sure the call that you want to switch to is highlighted.</li> <li>2. Press <b>⊙</b>. Any active call is placed on hold and the selected call is resumed.</li> </ol>
Switch from a connected call to answer a ringing call	Press <b>Answer</b> . Any active call is placed on hold.

## Switching an In-Progress Call to Another Phone

You can switch in-progress calls between the desktop phone and your cellular phone or other remote destination.

If you want to...	Then...
Switch an in-progress call on your desktop phone to a cellular phone	<ol style="list-style-type: none"> <li>1. Press the <b>Mobility</b> softkey and select <b>Send call to mobile</b>.</li> <li>2. Answer the in-progress call on your cellular phone.</li> </ol>
Switch an in-progress call from a cellular phone to your desktop phone	<ol style="list-style-type: none"> <li>1. Hang up the call on your cellular phone to disconnect the cellular phone, but not the call.</li> <li>2. Press <b>Resume</b> on your desk phone within 4 seconds and start talking on the desk phone.</li> </ol>

## Viewing Multiple Calls

Understanding how multiple calls are displayed on your phone can help you organize your call-handling efforts.

Your phone displays calls as follows for the highlighted line:

- Calls with the highest precedence and longest duration display at the top of the list.
- Calls of a similar type are grouped together. For example, calls that you have interacted with are grouped near the top, and calls on hold are grouped last.

# Transferring Calls

Transfer redirects a connected call. The *target* is the number to which you want to transfer the call.

If you want to...	Then...
Transfer a call without talking to the transfer recipient	<ol style="list-style-type: none"><li>1. From an active call, press <b>Transfer</b>.</li><li>2. Enter the target number.</li><li>3. Press <b>Transfer</b> again to complete the transfer or <b>EndCall</b> to cancel.</li></ol> <p><b>Note</b> If your phone has on-hook transfer enabled, complete the transfer by hanging up.</p>
Talk to the transfer recipient before transferring a call (consult transfer)	<ol style="list-style-type: none"><li>1. From an active call, press <b>Transfer</b>.</li><li>2. Enter the target number.</li><li>3. Wait for the transfer recipient to answer.</li><li>4. Press <b>Transfer</b> again to complete the transfer or <b>EndCall</b> to cancel.</li></ol> <p><b>Note</b> If your phone has on-hook transfer enabled, complete the transfer by hanging up.</p>
Transfer two current calls to each other (direct transfer) without staying on the line (SCCP phones only)	<ol style="list-style-type: none"><li>1. Scroll to highlight any call on the line.</li><li>2. Press <b>Select</b>.</li><li>3. Repeat this process for the second call.</li><li>4. With one of the selected calls highlighted, press <b>DirTrfr</b>. (To display <b>DirTrfr</b>, you might need to press <b>more</b>.)</li></ol> <p>The two calls connect to each other and drop you from the call.</p> <p><b>Note</b> If you want to stay on the line with the callers, use <b>Join</b> instead.</p>
Redirect a call to a voice message system	Press <b>iDivert</b> . For more information, see <a href="#">Sending a Call to a Voice Message System, page 19</a> .

## Tips

- If on-hook transfer is enabled on your phone, you can either hang up to complete the call, or press **Transfer** and then hang up.
- If on-hook transfer is *not* enabled on your phone, hanging up without pressing **Transfer** again places the call on hold.
- You cannot use **Transfer** to redirect a call on hold. Press  again to remove the call from hold before transferring it.

## Sending a Call to a Voice Message System

You can use **iDivert** to send an active, ringing, or on-hold call to your voice message system. Depending on the type of call and your phone configuration, you can also use **iDivert** to send the call to another party's voice message system.

- If the call was originally sent to someone else's phone, **iDivert** allows you to redirect the call either to your own voice message system or to the original called party's voice message system. Your system administrator must make this option available to you.
- If the call was sent to you directly (not transferred or forwarded to you), or if your phone does not support the option described above, using **iDivert** redirects the call to your voice message system.

If you want to...	Then...
Send an active, ringing, or on-hold call to a voice message system	Press <b>iDivert</b> . One of two things occurs: <ul style="list-style-type: none"> <li>• The call is transferred to your voice message system.</li> <li>• Your phone screen displays a menu that allows you to choose between your voice message system or the voice message system of the original called party. Choose an option to redirect the call.</li> </ul>

### Tip

If your phone displays a menu that disappears before you make your selection, you can press **iDivert** again to re-display the menu. You can also ask your system administrator to configure a longer timeout value.

## Forwarding All Calls to Another Number

You can use the Call Forward All feature to redirect incoming calls from your phone to another number.

If you want to...	Then...
Set up call forwarding on your line	Press <b>CFwdALL</b> and enter a target phone number.
Cancel call forwarding on your line	Press <b>CFwdALL</b> .
Verify that call forwarding is enabled on your line	Look for: <ul style="list-style-type: none"><li>• Alternating call forwarding icons  displayed next to your phone number.</li><li>• The call forward target number in the status line.</li></ul>
Set up or cancel call forwarding remotely	<ol style="list-style-type: none"><li>1. Log in to your User Options web pages. (See <a href="#">Accessing Your User Options Web Pages, page 48.</a>)</li><li>2. Access your call forwarding settings. (See <a href="#">Controlling Line Settings on the Web, page 54.</a>)</li></ol>

### Tips

- Enter the call forward target number exactly as you would dial it from your phone. For example, enter an access code or the area code, if necessary.
- You can forward your calls to a traditional analog phone or to another IP phone, although your system administrator might restrict the call forwarding feature to numbers within your company.
- Call forwarding is phone line specific. If a call reaches you on a line where call forwarding is not enabled, the call will ring as usual.
- Your system administrator can enable a call forward override feature that allows the person receiving your forwarded calls to reach you. With override enabled, a call placed from the target phone to your phone is not forwarded, but rings through.
- Your system administrator can change call forwarding conditions for your phone line.

## Using Do Not Disturb

You can use Do Not Disturb (DND) to block incoming calls from ringing on your phone. Your system administrator enables DND for your phone.

When DND and Call Forward All are both enabled on your phone, calls are forwarded and the caller does not hear a busy tone.

If you want to...	Then...
Turn on DND	Press <b>DND</b> . “Do Not Disturb” displays on the status line, and the ring tone is turned off.
Turn off DND	Press the DND softkey or: <ol style="list-style-type: none"> <li>1. Press <b>Ⓞ</b> &gt; <b>Device Configuration</b> &gt; <b>Call Preferences</b> &gt; <b>Do Not Disturb</b>.</li> <li>2. Select <b>No</b>, and then press <b>Save</b>.</li> </ol>
Customize DND settings	<ol style="list-style-type: none"> <li>1. Log in to your User Options web pages. See <a href="#">Accessing Your User Options Web Pages, page 48</a>.</li> <li>2. From the drop-down menu, choose <b>User Options</b> &gt; <b>Device</b>.</li> <li>3. You can set the following options: <ul style="list-style-type: none"> <li>- Do Not Disturb—Set to enable/disable DND.</li> <li>- DND Incoming Call Alert—Set the alert to beep only or disable all visible and audible alert notifications.</li> </ul> </li> </ol>

## Making Conference Calls

Your Cisco Unified IP Phone allows you to join three or more people into one telephone conversation, creating a conference call.

## Understanding Types of Conference Calls

There are two types of conference calls: Standard (ad hoc) and Meet-Me.

### Standard Conference Calls

You can create a standard conference in different ways, depending on your needs and the softkeys available on your phone:

- **Confrn**—Use this softkey to establish a standard conference by calling each participant. Standard conference calling is a default feature available on most phones.
- **Join**—Use this softkey to establish a standard conference by joining several calls already in progress on one line. (SCCP phones only.)
- **cBarge**—Use this softkey to add yourself to an existing call on a shared line and to turn the call into a standard conference call. This feature is available only on phones that use shared lines.

See [Starting and Joining a Standard Conference, page 22](#) for additional instructions.





## Meet-Me Conference Calls

You can create a Meet-Me conference by calling the Meet-Me phone number at a specified time. See [Starting or Joining a Meet-Me Conference Call, page 24](#) for additional instructions.

## Starting and Joining a Standard Conference

A standard (ad hoc) conference allows at least three participants to talk on a single call.

If you want to...	Then...
<ul style="list-style-type: none"><li>• Create a conference by calling participants</li><li>• Add new participants to an existing conference</li></ul>	<ol style="list-style-type: none"><li>1. From a connected call, press <b>Confrn</b>. (You may need to press the <b>more</b> softkey to see <b>Confrn</b>.)</li><li>2. Enter the participant's phone number.</li><li>3. Wait for the call to connect.</li><li>4. Press <b>Confrn</b> again to add the participant to your call.</li><li>5. Repeat to add additional participants.</li></ol> <p>Check with your system administrator to see if non-initiators of a conference can add or remove participants.</p>
Create a conference by joining two or more existing calls (SCCP phones only)	<ol style="list-style-type: none"><li>1. Make sure that you have two or more calls on a single line.</li><li>2. Highlight a call that you want to add to the conference.</li><li>3. Press <b>Select</b>. The selected call displays this icon <input checked="" type="checkbox"/>.</li><li>4. Repeat this process for each call that you want to add.</li><li>5. From one of the selected calls, press <b>Join</b>. (You may need to press the <b>more</b> softkey to see <b>Join</b>.)</li></ol> <p><b>Note</b> The active call is automatically selected.</p>
Participate in a conference	Answer the phone when it rings.
Create a conference by barging a called on shared line	Highlight a call on a shared line and press <b>cBarge</b> . (You may need to press the <b>more</b> softkey to display <b>cBarge</b> .) See <a href="#">Using a Shared Line, page 28</a> .
View a list of conference participants	<ol style="list-style-type: none"><li>1. Highlight an active conference.</li><li>2. Press <b>Conflist</b>. Participants are listed in the order in which they join the conference with the most recent additions at the top.</li></ol>
Get an updated list of participants	While viewing the conference list, press <b>Update</b> .

If you want to...	Then...
See who started the conference	While viewing the conference list, locate the person listed at the bottom of the list with an asterisk (*) next to the name.
Drop the last party added to the conference	Press <b>RMLstC</b> . You can remove participants only if you initiated the conference call.
Remove any conference participant	<ol style="list-style-type: none"> <li>1. Highlight the participant's name.</li> <li>2. Press <b>Remove</b>.</li> </ol> You can remove participants only if you initiated the conference.
End your participation in a conference	Hang up or press <b>EndCall</b> .
Join together two standard conferences on the same line	On SCCP phones, use the <b>Join</b> or <b>DirTrfr</b> softkeys. On SIP phones, use the <b>Confrn</b> or <b>Transfer</b> softkeys. Check with your system administrator to see if this feature is available to you.
Verify that a conference call is secure	Look for the  or  icon after “Conference” on the phone screen.
Remove a non-secure participant from a conference	While viewing the Conference List, locate the participant without the  or  icon, and press <b>Remove</b> . Check with your system administrator to see if non-initiators of a conference can remove participants.

## Tips

- To start a secure conference, you must use a phone configured with security.
- Non-secure conferences and participants display a  icon.
- Calls must be on the same line before you can add them to a conference using **Confrn** or **Join**. (**Join** is available on SCCP phones only.)
- Depending on how your phone is configured, if you leave a conference after initiating it, the conference might end. To avoid this, transfer the conference before hanging up.

## Starting or Joining a Meet-Me Conference Call

Meet-Me conferencing allows you to start or join a conference by dialing the conference number.

If you want to...	Then...
Start a Meet-Me conference	<ol style="list-style-type: none"><li>1. Obtain a Meet-Me phone number from your system administrator.</li><li>2. Distribute the number to participants.</li><li>3. When you are ready to start the meeting, go off-hook to invoke a dial tone, then press <b>MeetMe</b>.</li><li>4. Dial the Meet-Me conference number.  Participants can now join the conference by dialing in.</li></ol> <p><b>Note</b> Participants hear a busy tone if they call the conference before the initiator has joined. In this case, participants must call back.</p>
Join a Meet-Me conference	Dial the Meet-Me conference number (provided by the conference initiator).  <p><b>Note</b> You will hear a busy tone if you call the conference before the initiator has joined. In this case, try your call again.</p>
End a Meet-Me conference	All participants must hang up.  The conference does not automatically end when the conference initiator disconnects.



### Tip

If you call a secure Meet-Me conference number from a non-secure phone, your phone displays the message, “Device Not Authorized.” For more information, see [Making and Receiving Secure Calls](#), page 30.



# Advanced Call Handling

Advanced call-handling tasks involve special features that your system administrator might configure for your phone depending on your call-handling needs and work environment.

## Speed Dialing



Speed dialing allows you to enter an index number or select a phone screen item to place a call. Depending on configuration, your phone can support several speed-dial features:

- Speed Dials
- Abbreviated Dialing
- Fast Dials



### Note

- To set up speed-dial numbers and Abbreviated Dial, you must be able to access your User Options web pages. See [Using the User Options Web Pages, page 48](#).
- To set up Fast Dials, you must have access to the Personal Directory feature. See [Using Personal Directory on Your Phone, page 44](#).
- Alternately, your system administrator can configure speed-dial features for you.

If you want to...	Then...
Use Speed Dials	<ol style="list-style-type: none"> <li>1. Set up speed-dial numbers. See <a href="#">Setting Up Speed Dials on the Web, page 51</a>.</li> <li>2. To place a call, press , or press  and select <b>Directories &gt; Speed Dials</b>.</li> </ol>
Use Abbreviated Dial	<ol style="list-style-type: none"> <li>1. Set up Abbreviated Dialing codes. See <a href="#">Setting Up Speed Dials on the Web, page 51</a>.</li> <li>2. To place a call, enter the Abbreviated Dialing code and press <b>AbbrDial</b>.</li> </ol>
Use Fast Dial	<ol style="list-style-type: none"> <li>1. Create a Personal Address Book entry and assign a Fast Dial code. See <a href="#">Using Personal Directory on the Web, page 49</a>.</li> <li>2. To place a call, access the Fast Dial service on your phone. See <a href="#">Using Personal Directory on Your Phone, page 44</a>.</li> </ol>

# Picking Up a Redirected Call on Your Phone

Call PickUp allows you to answer a call that is ringing on a co-worker's phone by redirecting the call to your phone. You might use Call PickUp if you share call-handling with coworkers.

If you want to...	Then...
Answer a call that is ringing on another extension within your call pickup group	<ol style="list-style-type: none"><li>1. Do one of the following:<ul style="list-style-type: none"><li>– If the <b>PickUp</b> softkey is available, press it.</li><li>– If the <b>PickUp</b> softkey is not available, go off-hook to display it, then press <b>PickUp</b>.</li></ul>If your phone supports auto-pickup, you are now connected to the call.</li><li>2. If the call rings, press <b>Answer</b> to connect to the call.</li></ol>
Answer a call that is ringing on another extension outside of your group	<ol style="list-style-type: none"><li>1. Do one of the following:<ul style="list-style-type: none"><li>– If the <b>GPickUp</b> softkey is available, press it.</li><li>– If the <b>GPickUp</b> softkey is not available, go off-hook to display it, then press <b>GPickUp</b>.</li></ul></li><li>2. Enter the group pickup code. If your phone supports auto-pickup, you are now connected to the call.</li><li>3. If the call rings, press <b>Answer</b> to connect to the call.</li></ol>
Answer a call that is ringing on another extension in your group or in an associated group	<ol style="list-style-type: none"><li>1. Do one of the following:<ul style="list-style-type: none"><li>– If the <b>OPickUp</b> softkey is available, press it.</li><li>– If the <b>OPickUp</b> softkey is not available, go off-hook to display it, then press <b>OPickUp</b>.</li></ul>If your phone supports auto-pickup, you are now connected to the call.</li><li>2. If the call rings, press <b>Answer</b> to connect to the call.</li></ol>

## Tips

- Depending on how your phone is configured, you might receive an audio and/or visual alert about a call to your pickup group.
- Pressing **PickUp** and **GPickUp** connects you to the call that has been ringing for the longest time.
- Pressing **OPickUp** connects you to the call in the pickup group with the highest priority.

## Storing and Retrieving Parked Calls

You can park a call when you want to store the call so that you or someone else can retrieve it from another phone in the Cisco Unified Communications Manager system (for example, a phone at a co-worker's desk or in a conference room). You can park a call by using these methods:

- **Call Park**—Use the **Park** softkey to store the call. Your phone displays the call park number where the system stored your call. You must record this number and then use the same number to retrieve the call.
- **Directed Call Park**—Use the **Transfer** softkey to direct the call to an available directed call park number that you dial or speed dial. To retrieve the call from a directed call park number, you must dial the park retrieval prefix and then dial or speed dial the same directed call park number.

If you want to...	Then...
Store an active call using Call Park	<ol style="list-style-type: none"> <li>1. During a call, press <b>Park</b>. (You may need to press the <b>more</b> softkey to see <b>Park</b>.)</li> <li>2. Record the call park number displayed on your phone screen.</li> <li>3. Hang up.</li> </ol>
Retrieve a parked call	Enter the call park number from any Cisco Unified IP Phone in your network to connect to the call.
Direct and store an active call at a directed call park number	<ol style="list-style-type: none"> <li>1. During a call, press <b>Transfer</b>.</li> <li>2. Select a speed-dial number assigned to a directed call park number or dial the number.</li> <li>3. Press <b>Transfer</b> again to finish storing the number.</li> </ol>
Retrieve a parked call from a directed call park number	Cisco Unified IP Phone in your network, enter the park retrieval prefix and dial the directed call park number, or after entering the park retrieval prefix, select the speed-dial for the directed call park number to connect to the call.

### Tip

You have a limited time to retrieve a parked call before it reverts to ringing at the original number. See your system administrator for details.

## Logging Out of Hunt Groups

If your organization receives a large number of incoming calls, you might be a member of a hunt group. A hunt group includes a series of directory numbers that share the incoming call load. When the first directory number in the hunt group is busy, the system hunts for the next available directory number in the group and directs the call to that phone.

When you are away from your phone, you can prevent hunt group calls from ringing your phone by logging out of hunt groups.

If you want to...	Then...
Log out of hunt groups to temporarily block hunt group calls	Press <b>HLog</b> . Your phone screen displays, “Logged out of Hunt Group.”
Log in to receive hunt group calls	Press <b>HLog</b> .

### Tip

Logging out of hunt groups does not prevent non-hunt group calls from ringing your phone.

## Using a Shared Line

Your system administrator might ask you to use a shared line if you:

- Have multiple phones and want one phone number
- Share call-handling tasks with coworkers
- Handle calls on behalf of a manager

## Understanding Shared Lines

### Remote-in-Use Icon

The remote-in-use icon  appears when another phone that shares your line has a connected call. You can place and receive calls as usual on the shared line, even when the remote-in-use icon appears.

### Sharing Call Information and Barging

Phones that share a line each display information about calls that are placed and received on the shared line. This information might include caller ID and call duration. (See [Privacy, page 29](#) for exceptions.)

When call information is visible in this way, you and coworkers who share a line can add yourselves to calls using either **Barge** or **cBarge**. See [Adding Yourself to a Shared-Line Call, page 29](#).

## Privacy

If you do not want coworkers who share your line to see information about your calls, enable the Privacy feature. Doing so also prevents coworkers from barging your calls. See [Preventing Others from Viewing or Barging a Shared-Line Call](#), page 30.





---

**Note** The maximum number of calls that a shared line supports can vary by phone.

---

## Adding Yourself to a Shared-Line Call

Depending on how your phone is configured, you can add yourself to a call on a shared line using either Barge or cBarge.



If you want to...	Then...
See if the shared line is in use	Look for the remote-in-use icon  .
Add yourself to a call on a shared line using the <b>Barge</b> softkey	<ol style="list-style-type: none"> <li>1. Highlight a remote-in-use call.</li> <li>2. Press <b>Barge</b>. (You may need to press the <b>more</b> softkey to display <b>Barge</b>.)</li> </ol> <p>Other parties hear a beep tone announcing your presence.</p>
Add yourself to a call on a shared line using the <b>cBarge</b> softkey	<ol style="list-style-type: none"> <li>1. Highlight a remote-in-use call.</li> <li>2. Press <b>cBarge</b>. (You may need to press the <b>more</b> softkey to display <b>cBarge</b>.)</li> </ol> <p>Other parties hear a tone and brief audio interruption, and call information changes on the phone screen.</p>
Add new conference participants to a call that you have barged	<p>Barge the call using <b>cBarge</b>, if available.</p> <p>Unlike <b>Barge</b>, <b>cBarge</b> converts the call into a standard (ad hoc) conference call, allowing you to add new participants. See <a href="#">Making Conference Calls</a>, page 21.</p>
Leave a barged call	<p>Hang up.</p> <p>If you hang up after using <b>Barge</b>, the remaining parties hear a disconnect tone and the original call continues.</p> <p>If you hang up after using <b>cBarge</b>, the call remains a conference call (provided at least three participants remain on the line).</p>

## Tips

- If a phone that is using the shared line has Privacy enabled, call information and barge softkeys will not appear on the other phones that share the line.
- You will be disconnected from a call that you have joined using **Barge** if the call is put on hold, transferred, or turned into a conference call.

## Preventing Others from Viewing or Barging a Shared-Line Call

If you share a phone line, you can use the Privacy feature to prevent others who share the line from viewing or barging (adding themselves to) your calls.

If you want to...	Then...
Prevent others from viewing or barging calls on a shared line	<ol style="list-style-type: none"><li>1. Press <b>more</b> &gt; <b>Private</b>.</li><li>2. To verify that Privacy is on, look for the Privacy-enabled icon  next to “Private” on the phone screen.</li></ol>
Allow others to view or barge calls on a shared line	<ol style="list-style-type: none"><li>1. Press <b>more</b> &gt; <b>Private</b>.</li><li>2. To verify that Privacy is off, look for the Privacy-disabled icon  next to “Private” on the phone screen.</li></ol>

## Tip



If the phone that shares your line has Privacy enabled, you can make and receive calls using the shared line as usual.

## Making and Receiving Secure Calls

Depending on how your system administrator has configured your phone system, your phone might support making and receiving secure calls.

Your phone can support these types of calls:

- *Authenticated* call—The identities of all phones participating in the call have been verified.
- *Encrypted* call—The phone is receiving and transmitting encrypted audio (your conversation) within the Cisco IP network. Encrypted calls are also authenticated.
- *Non-secure* call—At least one of the participating phones or the connection does not support these security features, or the phones cannot be verified.

If you want to...	Then...
Check the security level of a call or conference	Look for a security icon in the top right corner of the call activity area, next to the call duration timer: <ul style="list-style-type: none"> <li data-bbox="565 305 989 342"> Authenticated call or conference</li> <li data-bbox="565 375 946 412"> Encrypted call or conference</li> <li data-bbox="565 444 959 482"> Non-secure call or conference</li> </ul>
Determine if secure calls can be made in your company	Contact your system administrator.

**Note**

There are interactions, restrictions, and limitations that affect how security features work on your phone. For more information, ask your system administrator.

## Tracing Suspicious Calls

(SCCP phones only)

If you are receiving suspicious or malicious calls, your system administrator can add the Malicious Call Identification (MCID) feature to your phone. This feature enables you to identify an active call as suspicious, which initiates a series of automated tracking and notification messages.

If you want to...	Then...
Notify your system administrator about a suspicious or harassing call	Press <b>MCID</b> . Your phone plays a tone and displays the message, “MCID successful.”

# Prioritizing Critical Calls

(SCCP phones only)

In some specialized environments, such as military or government offices, you might need to make and receive urgent or critical calls. If you have the need for this specialized call handling, your system administrator can add Multilevel Precedence and Preemption (MLPP) to your phone.

Keep these terms in mind:

- *Precedence* indicates the priority associated with a call.
- *Preemption* is the process of ending an existing, lower priority call while accepting a higher priority call that is sent to your phone.

If you...	Then...
Want to choose a priority (precedence) level for an outgoing call	Contact your system administrator for a list of corresponding precedence numbers for calls.
Want to make a priority (precedence) call	Enter the MLPP access number (provided by your system administrator) followed by the phone number.
Hear a special ring (faster than usual) or special call waiting tone	You are receiving a priority (precedence) call. An MLPP icon on your phone screen indicates the priority level of the call.
Want to view priority level of a call	Look for an MLPP icon on your phone screen: <ul style="list-style-type: none"><li>▣ Priority call</li><li>▣ Medium priority (immediate) call</li><li>▣ High priority (flash) call</li><li>▣ Highest priority (flash override) or Executive Override call</li></ul> Higher priority calls are displayed at the top of your call list. If you do not see an MLPP icon, the priority level of the call is normal (routine).
Want to accept a higher-priority call	Answer the call as usual. If necessary, end an active call first.
Hear a continuous tone interrupting your call	You or the other party are receiving a call that must preempt the current call. Hang up immediately to allow the higher priority call to ring through.

## Tips



- When you make or receive an MLPP-enabled call, you will hear special ring tones and call waiting tones that differ from the standard tones.
- If you enter an invalid MLPP access number, a verbal announcement will alert you of the error.



- An MLPP-enabled call retains its priority and preemptive status when you:
  - Put the call on hold
  - Transfer the call
  - Add the call to a three-way conference
  - Answer the call using PickUp
- MLPP overrides the Do Not Disturb (DND) feature.

## Using Cisco Extension Mobility

Cisco Extension Mobility (EM) allows you to temporarily configure a Cisco Unified IP Phone as your own. Once you log in to EM, the phone adopts your user profile, including your phone lines, features, established services, and web-based settings. Your system administrator must configure EM for you.

If you want to...	Then...
Log in to EM	<ol style="list-style-type: none"> <li>1. Press  and choose <b>Services &gt; EM Service</b> (name can vary).</li> <li>2. Enter your user ID and PIN (provided by your system administrator).</li> <li>3. If prompted, select a device profile.</li> </ol>
Log out of EM	<ol style="list-style-type: none"> <li>1. Press  and choose <b>Services &gt; EM Service</b> (name can vary).</li> <li>2. When prompted to log out, press <b>Yes</b>.</li> </ol>

### Tips

- EM automatically logs you out after a certain amount of time. Your system administrator establishes this time limit.
- Changes that you make to your EM profile (from the User Options web pages) take effect the next time that you log in to EM on a phone.
- Local settings controlled by the phone are not maintained in your EM profile.

# Managing Business Calls Using a Single Phone Number

With Mobile Connect and Mobile Voice Access installed, you can use your cellular phone to handle calls associated with your desktop phone number. A *smartphone* is a mobile phone with personal computer capabilities such as web browsing, email, address book, and calendar.

If you want to...	Then...
Configure Mobile Connect	Use the User Options web pages to set up remote destinations and create access lists to allow or block calls from specific phone numbers from being passed to the remote destinations. See <a href="#">Setting Up Phones and Access Lists for Mobile Connect, page 57</a> .
Answer a call using your cellular phone	See <a href="#">Answering a Call, page 14</a> .
Switch an in-progress call between your desk phone and cellular phone	See <a href="#">Switching an In-Progress Call to Another Phone, page 17</a> .
Put a call that has been picked up on a smartphone on hold	<ol style="list-style-type: none"><li>1. Press the <i>Enterprise Hold</i> (name may vary) softkey on the smartphone. The other party is placed on hold.</li><li>2. On your smartphone, press the <i>Resume Softkey</i> (name may vary). See <a href="#">Switching an In-Progress Call to Another Phone, page 17</a>.</li></ol>
Transfer a call that has been picked up on a smartphone to another number	<ol style="list-style-type: none"><li>1. Press the <i>Enterprise Transfer</i> (name may vary) softkey on the smartphone.</li><li>2. Dial your enterprise access code for transferring calls to initiate a new call. The other party is placed on hold.</li><li>3. Press the <i>Enterprise Transfer</i> softkey to complete the call transfer.</li></ol>
Initiate a conference call on a call that has been picked up on a smartphone	<ol style="list-style-type: none"><li>1. Press the <i>Enterprise Conference</i> (name may vary) softkey on the smartphone.</li><li>2. Dial your enterprise access code for conferencing to initiate a new call. The other party is placed on hold.</li><li>3. Press the <i>Enterprise Conference</i> softkey to complete the conference set-up and include both callers in the conference.</li></ol>
Connect to Mobile Voice Access	<ol style="list-style-type: none"><li>1. From any phone, dial your assigned Mobile Voice Access number.</li><li>2. Enter the number you are calling from, if prompted, and your PIN.</li></ol>

If you want to...	Then...
Turn on Mobile Connect from your cellular phone	<ol style="list-style-type: none"> <li>1. Dial your assigned Mobile Voice access number.</li> <li>2. Enter your cellular phone number (if requested) and PIN.</li> <li>3. Press 2 to enable Mobile Connect.</li> <li>4. Choose whether to turn Mobile Connect on for all configured phones or just one: <ul style="list-style-type: none"> <li>– All phones—Enter 2.</li> <li>– One phone—Enter 1 and enter the number you want to add as a remote destination, followed by #.</li> </ul> </li> </ol>
Make a call from your cellular phone	See <a href="#">Placing a Call—Additional Options, page 13</a> .
Turn off Mobile Connect from your cellular phone	<ol style="list-style-type: none"> <li>1. Dial your assigned Mobile Voice access number.</li> <li>2. Enter your cellular phone number (if requested) and PIN.</li> <li>3. Press 3 to disable Mobile Connect.</li> <li>4. Choose whether to turn Mobile Connect off for all configured phones or just one: <ul style="list-style-type: none"> <li>– All phones—Enter 2.</li> <li>– One phone—Enter 1 and enter the number you want to remove as a remote destination, followed by #.</li> </ul> </li> </ol>

## Tips

- When calling Mobile Voice Access, you need to enter the number you are call from in addition to the PIN if any of the following are true:
  - The number you are calling from is not one of your remote destinations.
  - The number is blocked by you or your carrier (shown as “Unknown Number”).
  - The number is not accurately matched in the Cisco Unified Communications Manager database; for example, if your number is 510-666-9999, but it is listed as 666-9999 in the database, or your number is 408-999-6666, but it is entered as 1-408-999-6666 in the database.
- If you incorrectly enter any requested information (such as cellular phone number or PIN) three times in a row, the Mobile Voice Access call disconnects, and you are locked out for a period of time. Contact your system administrator if you need assistance.

# Using a Handset, Headset, and Speaker

---

The Cisco Unified IP Phone 7906G and 7911G provide a speaker for hands-free listening. You can use the speaker only to listen to a call. To talk on a call, you must use the handset.

You can use the speaker in one of two ways, depending on how your system administrator enables the phone. Your phone may be enabled for one of the following features, but not both at the same time:

- Group Listen
- Monitor (default)

## Using the Group Listen Feature

The following table shows how you can use the Group Listen feature.

<b>If you want to...</b>	<b>Then...</b>
Use the handset	Lift it to go off-hook; replace it to go on-hook.
Talk using the handset and listen on the speaker at the same time (Group Listen)	Press <b>GListen</b> . <b>Note</b> Group Listen must be enabled by your system administrator for the <b>GListen</b> softkey to display.
Turn off Group Listen and use the handset	Press <b>GLOff</b> .
Hang up after using Group Listen	Press <b>EndCall</b> or hang up.
Adjust the volume level for a call	<b>Note</b> When using Group Listen, adjusting the volume only changes the volume for the speaker and not the handset.  Press the up or down <b>Volume</b> button during a call or after invoking a dial tone.  Press <b>Save</b> to preserve the volume level for future calls.

## Using the Monitor Feature

The following table shows how you can use the Monitor feature.

If you want to...	Then...
Use the handset	Lift it to go off-hook; replace it to go on-hook.
Listen to the call on the speaker	Press <b>Monitor</b> and then hang up the handset. You will be able to hear the call but you will not be able to talk on the call. <b>Note</b> The <b>Monitor</b> and <b>MonOff</b> softkeys are not available if Group Listen is enabled.
Turn off the speaker and use the handset	Lift the handset, or press <b>MonOff</b> . <b>Note</b> The <b>Monitor</b> and <b>MonOff</b> softkeys are not available if Group Listen is enabled.
Turn off the speaker and hang up	Press <b>EndCall</b> .
Adjust the speaker volume level for a call	Press the up or down <b>Volume</b> button during a call or after invoking a dial tone. Press <b>Save</b> to preserve the volume level for future calls.

### Tips

- If your system administrator has disabled the speaker on your phone, the **GListen**, **GLOff**, **Monitor**, and **MonOff** softkeys will not be available to you. You must lift the handset to place and monitor calls.
- Pressing the **Volume** button changes the volume for the handset or speaker, depending on which device is in use. In Group Listen and Monitor modes, the volume adjustment is for the speaker and not the handset.



### Note

If you need to change the wideband setting for your handset (for example, if you change your handset) press  and choose **Settings > User Preferences > Audio Preferences > Wideband Handset**. If the Wideband Handset setting shows as dimmed, then this setting is not user controllable.

Check with your system administrator to be sure your phone system is configured to use wideband. If the system is not configured for wideband, you may not detect any additional audio sensitivity even when using a wideband handset. To learn more, refer to the handset documentation or ask your system administrator for assistance.

## Using and Obtaining a Headset

To use a headset, disconnect the handset and connect a headset to the Handset port.

If you connect a headset to the handset port, be sure that the Wideband Handset setting is disabled. Choose **User Preferences > Audio Preferences > Wideband Handset**.



---

**Note** If the Wideband Handset setting shows as dimmed, then this setting is not user controllable and you must contact your system administrator to change this setting.

---

For information about purchasing headsets, see [Headset Information, page 6](#). Depending on headset manufacturer's recommendations, an external amplifier may be required. Refer to headset manufacturer's product documentation for more information.

## Using AutoAnswer

When AutoAnswer is enabled, your phone answers incoming calls automatically after a few rings. Your system administrator can configure AutoAnswer to use the speaker to answer calls. However, you can only monitor the call using the speaker. To talk to the caller, you must pick up the handset.



---

**Tip** AutoAnswer is disabled when Do Not Disturb is active.

---

# Changing Phone Settings

You can personalize your Cisco Unified IP Phone by adjusting the ring tone, background image, and other settings.

## Customizing Rings and Message Indicators

You can customize how your phone indicates an incoming call and a new voice message. You can also adjust the ringer volume for your phone.

If you want to...	Then...
Change the ring tone	<ol style="list-style-type: none"> <li>1. Press  and select <b>Settings &gt; User Preferences &gt; Rings</b>.</li> <li>2. Select a ring tone and press <b>Play</b> to hear a sample.</li> <li>3. Press <b>Save</b> to set the ring tone, or press <b>Cancel</b>.</li> </ol>
Change the ring pattern (flash-only, ring once, beep-only, etc.)	<p>Log in to your User Options web pages. (See the <a href="#">Accessing Your User Options Web Pages, page 48.</a>)</p> <ol style="list-style-type: none"> <li>1. Log in to your User Options web pages. (See <a href="#">Accessing Your User Options Web Pages, page 48.</a>)</li> <li>2. Access your call ring pattern settings. (See <a href="#">Controlling Line Settings on the Web, page 54.</a>)</li> </ol> <p><b>Note</b> Before you can access this setting, your system administrator might need to enable it for you.</p>
Adjust the volume level for the phone ringer	Press the Volume button while the handset is in the cradle. The new ringer volume is saved automatically.
Change the way that the voice message light on your handset works	<ol style="list-style-type: none"> <li>1. Log in to your User Options web pages. (See the <a href="#">Accessing Your User Options Web Pages, page 48.</a>)</li> <li>2. Choose <b>Change the Message Waiting Lamp policy...</b></li> <li>3. Access your message indicator settings. (See <a href="#">Controlling Line Settings on the Web, page 54.</a>)</li> </ol> <p><b>Note</b> Typically, the default system policy is to indicate a new voice message by displaying a steady light on the handset light strip.</p>

# Customizing the Phone Screen

You can adjust the characteristics of the phone screen.

If you want to...	Then...
Change the background image	<ol style="list-style-type: none"><li data-bbox="397 334 1225 391">1. Press  and choose <b>Settings &gt; User Preferences &gt; Background Images</b>.</li><li data-bbox="397 399 1225 431">2. Scroll through available images and press <b>Select</b> to choose an image.</li><li data-bbox="397 440 1225 472">3. Press <b>Preview</b> to see a larger view of the background image.</li><li data-bbox="397 480 1225 513">4. Press <b>Exit</b> to return to the selection menu.</li><li data-bbox="397 521 1225 553">5. Press <b>Save</b> to accept the new image, or press <b>Cancel</b>.</li></ol>
Change the language on the phone screen	<ol style="list-style-type: none"><li data-bbox="397 573 1225 630">1. Log in to your User Options web pages. (See <a href="#">Accessing Your User Options Web Pages, page 48.</a>)</li><li data-bbox="397 638 1225 703">2. Access your user settings. (See <a href="#">Controlling User Settings on the Web, page 53.</a>)</li></ol>
Change the line text label	<ol style="list-style-type: none"><li data-bbox="397 719 1225 776">1. Log in to your User Options web pages. (See <a href="#">Accessing Your User Options Web Pages, page 48.</a>)</li><li data-bbox="397 784 1225 849">2. Access your line text label settings. (See <a href="#">Controlling Line Settings on the Web, page 54.</a>)</li></ol>











# Using Call Logs and Directories

This section describes how you can use call logs and directories. To access both features, press  and select **Directories**.

## Using Call Logs

Your phone maintains logs of your missed, placed, and received calls.

If you want to...	Then...
View your call logs	Press  , and choose <b>Directories &gt; Missed Calls, Placed Calls, or Received Calls</b> . Each stores up to 100 records. To view a truncated listing, highlight it and press <b>EditDial</b> .
Display details for a single call record	<ol style="list-style-type: none"> <li>1. Press , choose <b>Directories &gt; Missed Calls, Placed Calls, or Received Calls</b>.</li> <li>2. Highlight a call record.</li> <li>3. Press <b>Details</b>. Doing so displays information such as called number, calling number, time of day, and call duration (for placed and received calls only).</li> </ol>
Erase all call records in all logs	Press  , choose <b>Directories</b> , then press <b>Clear</b> .
Erase all call records in a single log	<ol style="list-style-type: none"> <li>1. Press , choose <b>Directories &gt; Missed Calls, Placed Calls, or Received Calls</b>.</li> <li>2. Highlight a call record.</li> <li>3. Press <b>Clear</b>. (You may need to press the <b>more</b> softkey to display <b>Clear</b>.)</li> </ol>
Erase a single call record	<ol style="list-style-type: none"> <li>1. Press , choose <b>Directories &gt; Missed Calls, Placed Calls, or Received Calls</b>.</li> <li>2. Highlight a call record.</li> <li>3. Press <b>Delete</b>.</li> </ol>

If you want to...	Then...
Dial from a call log (while not on another call)	<ol style="list-style-type: none"> <li>1. Press  and choose <b>Directories &gt; Missed Calls, Placed Calls, or Received Calls</b>.</li> <li>2. Highlight a call record from the log.</li> </ol> <p><b>Note</b> If the Details softkey appears, the call is the primary entry of a multiparty call. See the <a href="#">Tip</a> section below.</p> <ol style="list-style-type: none"> <li>3. If you need to edit the displayed number, press <b>EditDial</b> followed by &lt;&lt; or &gt;&gt;. To delete the number, press <b>EditDial</b> followed by <b>Delete</b>. (You may need to press the <b>more</b> softkey to display <b>Delete</b>.)</li> <li>4. Go off-hook to place the call.</li> </ol>
Dial from a call log (while connected to another call)	<ol style="list-style-type: none"> <li>1. Press , and choose <b>Directories &gt; Missed Calls, Placed Calls, or Received Calls</b>.</li> <li>2. Highlight a call record from the log.</li> </ol> <p><b>Note</b> If the Details softkey displays, the call is the primary entry of a multiparty call. See the <a href="#">Tip</a> section below.</p> <ol style="list-style-type: none"> <li>3. If you need to edit the displayed number, press <b>EditDial</b> followed by &lt;&lt; or &gt;&gt;. To delete the number, press <b>EditDial</b> followed by <b>Delete</b>. (You may need to press the <b>more</b> softkey to display <b>Delete</b>.)</li> <li>4. Press <b>Dial</b>.</li> <li>5. Choose one of the following to handle the original call: <ul style="list-style-type: none"> <li>– <b>Hold</b>—Puts the first call on hold.</li> <li>– <b>Transfer</b>—Transfers the first party to the second and drops you from the call. (Press <b>Transfer</b> again after dialing to complete the action.)</li> <li>– <b>Confrn</b>—Creates a conference call with all parties, including you. (Press <b>Confrn</b> again after dialing to complete the action.)</li> <li>– <b>EndCall</b>—Disconnects the first call and dials the second.</li> </ul> </li> </ol>
Place a call from a URL entry in a call log (SIP phones only)	<ol style="list-style-type: none"> <li>1. Press , and choose <b>Directories &gt; Missed Calls, Placed Calls, or Received Calls</b>.</li> <li>2. Highlight the URL entry that you want to dial.</li> <li>3. If you need to edit the entry, press <b>EditDial</b>. The  icon appears to indicate that you can begin editing characters in the URL entry.</li> <li>4. Press <b>Dial</b>.</li> </ol>

**Tip**

(SCCP phones only)

To view the complete call record of a multiparty call, press **Details**. The Details record shows two entries for each missed or received multiparty call. The entries are listed in reverse chronological order:

- The first logged entry is the name/number of the last completed call of a multiparty call received on your phone.
- The second logged entry is the name/number of the first completed call of a multiparty call received on your phone.

## Directory Dialing

Depending on configuration, your phone can provide corporate and personal directory features:

- **Corporate Directory**—Corporate contacts that you can access on your phone, Your system administrator sets up and maintains your Corporate Directory.
- **Personal Directory**—If available, personal contacts and associated speed-dial codes that you can configure and access from your phone and User Options web pages. Personal Directory comprises the Personal Address Book (PAB) and Fast Dials.
  - PAB is a directory of your personal contacts.
  - Fast Dials allows you to assign codes to PAB entries for quick dialing.
  - For more information, see [Using the User Options Web Pages, page 48](#).

## Using Corporate Directory on Your Phone

You can use a corporate directory to place calls to coworkers.

If you want to...	Then...
Dial from a corporate directory (while not on another call)	<ol style="list-style-type: none"> <li>1. Press <b>Ⓜ</b>, and choose <b>Directories &gt; Corporate Directory</b> (exact name can vary).</li> <li>2. Use your keypad to enter a full or partial name and press <b>Search</b>.</li> <li>3. To dial, select the listing, and go off-hook.</li> </ol>

If you want to...	Then...
Dial from a corporate directory (while connected to another call)	<ol style="list-style-type: none"> <li>1. Press , and choose <b>Directories &gt; Corporate Directory</b> (exact name can vary).</li> <li>2. Use your keypad to enter a full or partial name, and press <b>Search</b>.</li> <li>3. Scroll to a listing and press <b>Dial</b>.</li> <li>4. Choose one of the following to handle the original call: <ul style="list-style-type: none"> <li>- <b>Hold</b>—Puts the first call on hold.</li> <li>- <b>Transfer</b>—Transfers the first party to the second and drops you from the call. (Press <b>Transfer</b> again after dialing to complete the action.)</li> <li>- <b>Confrn</b>—Creates a conference call with all parties, including you. (Press <b>Confrn</b> again after dialing to complete the action.)</li> <li>- <b>EndCall</b>—Disconnects the first call and dials the second.</li> </ul> </li> </ol>

### Tip



Use the numbers on your keypad to enter characters on your phone screen. Use the Navigation button on your phone to move between input fields.

## Using Personal Directory on Your Phone

The Personal Directory feature set contains your Personal Address Book (PAB) and Fast Dial codes. This section describes how to set up and use Personal Directory on your phone. Alternately, see [Using Personal Directory on the Web, page 49](#).

If you want to...	Then...
Access Personal Directory (for PAB and Fast Dial codes)	<ol style="list-style-type: none"> <li>1. Press , and choose <b>Directories &gt; Personal Directory</b> (exact name can vary).</li> <li>2. Enter your Cisco Unified Communications Manager user ID and PIN, then press <b>Submit</b>.</li> </ol>
Search for a PAB entry	<ol style="list-style-type: none"> <li>1. Access Personal Directory, then choose <b>Personal Address Book</b>.</li> <li>2. Enter search criteria and press <b>Submit</b>.</li> <li>3. You can choose <b>Previous</b> or <b>Next</b> to move through listings.</li> <li>4. Highlight the PAB listing that you want and press <b>Select</b>.</li> </ol>

If you want to...	Then...
Dial from PAB entry	<ol style="list-style-type: none"> <li>1. Search for a listing.</li> <li>2. Highlight the listing and press <b>Select</b>.</li> <li>3. Press <b>Dial</b>. (You may need to press the <b>more</b> softkey to see <b>Dial</b>.)</li> <li>4. Enter the participant's phone number.</li> <li>5. Highlight the number that you want to dial and press <b>OK</b>.</li> <li>6. Press <b>OK</b> again to dial the number.</li> </ol>
Delete a PAB entry	<ol style="list-style-type: none"> <li>1. Search for a listing.</li> <li>2. Highlight the listing and press <b>Delete</b>.</li> <li>3. Choose <b>OK</b> to confirm the deletion.</li> </ol>
Edit a PAB entry	<ol style="list-style-type: none"> <li>1. Search for a listing.</li> <li>2. Highlight the listing and press <b>Edit</b> to modify a name or email address.</li> <li>3. If necessary, choose <b>Phones</b> to modify a phone number.</li> <li>4. Press <b>Update</b>.</li> </ol>
Add a new PAB entry	<ol style="list-style-type: none"> <li>1. Access Personal Directory, then choose <b>Personal Address Book</b>.</li> <li>2. Access the Search page by choosing <b>Submit</b>. (You do not need to input search information first.)</li> <li>3. Press <b>New</b>.</li> <li>4. Use your phone keypad to enter a name and email information.</li> <li>5. Choose <b>Phones</b> and use the keypad to enter phone numbers. Be sure to include any necessary access codes such as a 9 or 1.</li> <li>6. Choose <b>Submit</b> to add the entry to the database.</li> </ol>
Assign a Fast Dial code to a PAB entry	<ol style="list-style-type: none"> <li>1. Search for a PAB entry.</li> <li>2. Highlight the listing and press <b>Select</b>.</li> <li>3. Press <b>Fast Dial</b>.</li> <li>4. Highlight the number that you want to dial and press <b>Select</b>.</li> <li>5. Highlight the Fast Dial code that you want to assign to the number and press <b>Select</b>.</li> </ol>

If you want to...	Then...
Add a raw Fast Dial code (not using a PAB entry)	<ol style="list-style-type: none"> <li>1. Press , and choose <b>Directories &gt; Personal Directory &gt; Personal Fast Dials</b>.</li> <li>2. Press <b>Fast Dial</b>.</li> <li>3. Highlight a Fast Dial code that is unassigned and press <b>Select</b>.</li> <li>4. Press <b>Assign</b>.</li> <li>5. Enter a phone number.</li> <li>6. Press <b>Update</b>.</li> </ol>
Search for Fast Dial codes	<ol style="list-style-type: none"> <li>1. Press , and choose <b>Directories &gt; Personal Directory &gt; Personal Fast Dials</b>.</li> <li>2. You can choose <b>Previous</b> or <b>Next</b> to move through listings.</li> <li>3. Highlight the listing that you want and press <b>Select</b>.</li> </ol>
Place a call using a Fast Dial code	<ol style="list-style-type: none"> <li>1. Search for a Fast Dial code.</li> <li>2. Highlight the listing you want and press <b>Select</b>.</li> <li>3. Press <b>Dial</b>.</li> <li>4. Choose <b>OK</b> to complete the action.</li> </ol>
Delete a Fast Dial code	<ol style="list-style-type: none"> <li>1. Search for a Fast Dial code.</li> <li>2. Highlight the listing you want and press <b>Select</b>.</li> <li>3. Press <b>Remove</b>.</li> </ol>
Log out of Personal Directory	<ol style="list-style-type: none"> <li>1. Press , and choose <b>Directories &gt; Personal Directory</b> (exact name can vary).</li> <li>2. Choose <b>Logout</b>.</li> </ol>

## Tips



- Your system administrator can provide you the user ID and PIN that you need to log in to Personal Directory.
- Personal Directory automatically logs you out after a certain amount of time. This time limit can vary. Ask your system administrator for more information.
- Use the numbers on your keypad to enter characters on your phone screen. Use the Navigation button on your phone to move between input fields.

# Accessing Voice Messages

To access voice messages, press , and select **Messages**.



**Note** Your company determines the voice message service that your phone system uses. For the most accurate and detailed information, refer to the documentation that came with your voice message service.

If you want to...	Then...
Set up and personalize your voice message service	Do one of the following: <ul style="list-style-type: none"> <li>• Press <b>Msgs</b> and follow the voice instructions.</li> <li>• Press , select <b>Messages</b>, and follow the voice instructions.</li> </ul>
See if you have a new voice message	Look for: <ul style="list-style-type: none"> <li>• A steady red light on your handset. (This indicator can vary. See <a href="#">Customizing Rings and Message Indicators, page 39</a>.)</li> <li>• A flashing message waiting icon  on your phone screen.</li> </ul> Listen for: <ul style="list-style-type: none"> <li>• A stutter tone from your handset, headset, or speakerphone when you place a call.</li> </ul>
Listen to your voice messages or access the voice messages menu	Do one of the following: <ul style="list-style-type: none"> <li>• Press <b>Msgs</b> and follow the voice instructions.</li> <li>• Press , select <b>Messages</b>, and follow the voice instructions.</li> </ul>
Send a call to a voice message system	Press <b>Divert</b> . For more information, see <a href="#">Sending a Call to a Voice Message System, page 19</a> .

# Using the User Options Web Pages

---

Your Cisco Unified IP Phone is a network device that can share information with other network devices in your company, including your personal computer. You can use your computer to log in to your Cisco Unified CM User Options web pages, where you can control features, settings, and services for your Cisco Unified IP Phone. For example, you can set up speed-dial numbers from your User Options web pages.

## Accessing Your User Options Web Pages

This section describes how to log in and select a phone device.

If you want to...	Then do this...
Log in to your User Options web pages	<ol style="list-style-type: none"><li data-bbox="323 670 1170 727">1. Obtain a User Options URL, user ID, and default password from your system administrator.</li><li data-bbox="323 743 1134 768">2. Open a web browser on your computer, enter the URL, and log on.</li><li data-bbox="323 784 1163 812">3. If prompted to accept security settings, click <b>Yes</b> or <b>Install Certificate</b>.</li></ol> <p data-bbox="364 824 1208 914">The Cisco Unified Communications Manager User Options main web page displays. From this page you can select <b>User Options</b> to access User Settings, Directory features, a Personal Address Book, and Fast Dials.</p> <p data-bbox="364 927 1094 954">Or, to access phone-specific options, select a device (see below).</p>
Select a device after logging in	<ol style="list-style-type: none"><li data-bbox="323 971 1208 1027">1. After you have logged in to your User Options pages, choose <b>User Options &gt; Device</b>.</li></ol> <p data-bbox="364 1040 830 1068">The Device Configuration page displays.</p> <ol style="list-style-type: none"><li data-bbox="323 1081 1208 1170">2. If you have multiple devices assigned to you, choose the appropriate device (phone model, Extension Mobility profile, or Remote Destination profile) from the Name drop-down menu.</li></ol> <p data-bbox="317 1183 1184 1240"><b>Note</b> Toolbar buttons located at the top of the Device Configuration page are specific to the selected device type.</p>
Select a configuration option after logging in	<ol style="list-style-type: none"><li data-bbox="323 1255 1184 1344">1. After you have logged in to your User Options web pages, choose <b>User Options</b> to access User Settings, Directory, Personal Address Book, Fast Dials, and Mobility Settings.</li><li data-bbox="323 1357 1208 1414">2. To return to the Device Configuration page from another page, choose <b>User Options &gt; Device</b>.</li></ol>



## Configuring Features and Services on the Web

The topics in this section describe how to configure features and services from your User Options web pages after logging in. See [Accessing Your User Options Web Pages, page 48](#).

### Using Personal Directory on the Web

The Personal Directory feature set that you can access on your computer consists of:

- A Personal Address Book (PAB)
- Fast Dials
- Cisco Unified Communications Manager Address Book Synchronizer



**Note** You can also access PAB and Fast Dials from your phone. See [Using Personal Directory on Your Phone, page 44](#).

### Using Your Personal Address Book on the Web

This section describes how to use your PAB from the User Options web pages.

If you want to...	Then do this after you log in...
Add a new PAB entry	<ol style="list-style-type: none"> <li>1. Choose <b>User Options &gt; Personal Address Book</b>.</li> <li>2. Choose <b>Add New</b>.</li> <li>3. Enter information for the entry.</li> <li>4. Click <b>Save</b>.</li> </ol>
Search for a PAB entry	<ol style="list-style-type: none"> <li>1. Choose <b>User Options &gt; Personal Address Book</b>.</li> <li>2. Specify search information and click <b>Find</b>.</li> </ol>
Edit a PAB entry	<ol style="list-style-type: none"> <li>1. Search for a PAB entry.</li> <li>2. Click a name or nickname.</li> <li>3. Edit the entry as needed and click <b>Save</b>.</li> </ol>
Delete a PAB entry	<ol style="list-style-type: none"> <li>1. Search for a PAB entry.</li> <li>2. Select one or more entries.</li> <li>3. Click <b>Delete Selected</b>.</li> </ol>

## Configuring Fast Dials on the Web

This section describes how to assign Fast Dials from your User Options web pages.

If you want to...	Then do this after you log in...
Assign a Fast Dial code to a PAB entry	<ol style="list-style-type: none"><li>1. Create a PAB entry. See <a href="#">Using Your Personal Address Book on the Web, page 49</a>.</li><li>2. Choose <b>User Options &gt; Fast Dials</b>.</li><li>3. Click <b>Add New</b>.</li><li>4. Use the Search Options area to find the appropriate PAB entry.</li><li>5. Click a phone number in the Search Results area.</li><li>6. Change the Fast Dial code, if desired.</li><li>7. Click <b>Save</b>.</li></ol>
Assign a Fast Dial code to a phone number (without using a PAB entry)	<ol style="list-style-type: none"><li>1. Choose <b>User Options &gt; Fast Dials</b>.</li><li>2. Click <b>Add New</b>.</li><li>3. Change the Fast Dial code, if desired.</li><li>4. Enter a phone number.</li><li>5. Click <b>Save</b>.</li></ol>
Search for a Fast Dial entry	<ol style="list-style-type: none"><li>1. Choose <b>User Options &gt; Fast Dials</b>.</li><li>2. Specify search information and click <b>Find</b>.</li></ol>
Edit a Fast Dial phone number	<ol style="list-style-type: none"><li>1. Choose <b>User Options &gt; Fast Dials</b>.</li><li>2. Search for the Fast Dial entry that you want to edit.</li><li>3. Click on a component of the entry.</li><li>4. Change the phone number.</li><li>5. Click <b>Save</b>.</li></ol>
Delete a Fast Dial entry	<ol style="list-style-type: none"><li>1. Search for a Fast Dial.</li><li>2. Select one or more entries.</li><li>3. Click <b>Delete Selected</b>.</li></ol>

### Tips

- You can create up to 500 Fast Dial and PAB entries.
- You can create a new Fast Dial entry without using a PAB entry. Such Fast Dial entries are labeled “raw” in the User Options pages and do not display a configurable text label.

## Using the Address Book Synchronization Tool

You can use the Address Book Synchronization Tool (TABSynch) to synchronize your existing Microsoft Windows Address Book (if applicable) with your PAB. Entries from your Microsoft Windows Address Book will then be accessible on your Cisco Unified IP Phone and User Options web pages. Your system administrator can give you access to TABSynch and provide detailed instructions.

## Setting Up Speed Dials on the Web

Depending on configuration, your phone can support several speed-dial features:

- Speed-dial numbers
- Abbreviated Dialing
- Fast Dials



**Note** For help using speed dial features, see [Speed Dialing, page 25](#).

If you want to...	Then do this after you log in...
Set up speed-dial numbers	<ol style="list-style-type: none"> <li>1. Choose <b>User Options &gt; Device</b>.</li> <li>2. Choose a phone from the Name drop-down menu.</li> <li>3. Click <b>Speed Dials</b>.</li> <li>4. Enter a number and label for a speed-dial number on your phone.</li> <li>5. Click <b>Save</b>.</li> </ol> <p><b>Note</b> Your phone uses the ASCII Label field.</p>
Set up Abbreviated dialing	<ol style="list-style-type: none"> <li>1. Choose <b>User Options &gt; Device</b>.</li> <li>2. Choose a phone from the Name drop-down menu.</li> <li>3. Click <b>Speed Dials</b>.</li> <li>4. Enter a number and label for an Abbreviated Dialing code.</li> <li>5. Click <b>Save</b>.</li> </ol>
Set up Fast Dials	<p>See <a href="#">Configuring Fast Dials on the Web, page 50</a>.</p> <p>You can also set up Fast Dials on your phone. See <a href="#">Using Personal Directory on Your Phone, page 44</a>.</p>

## Setting Up Phone Services on the Web

Phone services can include special phone features, network data, and web-based information (such as stock quotes and movie listings). You must first subscribe to a phone service before accessing it on your phone.

<b>If you want to...</b>	<b>Then do this after you log in and select a device...</b>
Subscribe to a service	<ol style="list-style-type: none"><li>1. Choose <b>User Options &gt; Device</b>.</li><li>2. Choose a phone from the Name drop-down menu.</li><li>3. Click <b>Phone Services</b>.</li><li>4. Click <b>Add New</b>.</li><li>5. Choose a service from the drop-down list and click <b>Next</b>.</li><li>6. Change the service label and/or enter additional service information, if available (optional).</li><li>7. Click <b>Save</b>.</li></ol>
Search for services	<ol style="list-style-type: none"><li>1. Select a device.</li><li>2. Click <b>Phone Services</b>.</li><li>3. Click <b>Find</b>.</li></ol>
Change or end services	<ol style="list-style-type: none"><li>1. Search for services.</li><li>2. Select one or more entries.</li><li>3. Click <b>Delete Selected</b>.</li></ol>
Change a service name	<ol style="list-style-type: none"><li>1. Search for services.</li><li>2. Click on the service name.</li><li>3. Change the information and click <b>Save</b>.</li></ol>
Access a service on your phone	Choose  > <b>Services</b> .

## Controlling User Settings on the Web

User settings include your password, PIN, and language (locale) settings.

If you want to...	Then do this after you log in...
Change your password	<ol style="list-style-type: none"> <li>1. Choose <b>User Options &gt; User Settings</b>.</li> <li>2. In the Browser Password area, enter information.</li> <li>3. Click <b>Save</b>.</li> </ol>
Change your PIN	<ol style="list-style-type: none"> <li>1. Choose <b>User Options &gt; User Settings</b>.</li> <li>2. In the Phone PIN area, enter information.</li> <li>3. Click <b>Save</b>.</li> </ol>
Change the language (locale) for your User Options pages	<ol style="list-style-type: none"> <li>1. Choose <b>User Options &gt; User Settings</b>.</li> <li>2. In the User Locale area, choose an item from the Locale drop-down list.</li> <li>3. Click <b>Save</b>.</li> </ol>
Change the language (locale) for your phone screen	<ol style="list-style-type: none"> <li>1. Choose <b>User Options &gt; User Settings</b>.</li> <li>2. Choose an item from the User Locale drop-down list.</li> <li>3. Click <b>Save</b>.</li> </ol>

### Tip

Your PIN and password allow you to access different features and services. For example, use your PIN to log in to Cisco Extension Mobility or Personal Directory on your phone. Use your password to log in to your User Options web pages and Cisco WebDialer on your personal computer. For more information, ask your system administrator.

## Controlling Line Settings on the Web

Line settings affect a specific phone line (directory number) on your phone. Line settings can include call-forwarding, voice message indicators, ring patterns, and line labels.

You can set up other line settings directly on your phone:

- Set up call forwarding for your primary phone line—see [Forwarding All Calls to Another Number](#), page 20.
- Change rings, display, and other phone-model specific settings—see [Changing Phone Settings](#), page 39.

If you want to...	Then do this after you log in...
Set up call forwarding per line	<ol style="list-style-type: none"><li>1. Choose <b>User Options &gt; Device</b>.</li><li>2. Choose a phone from the Name drop-down menu.</li><li>3. Click <b>Line Settings</b>.</li><li>4. In the Incoming Call Forwarding area, choose call forwarding settings for various conditions.</li><li>5. Click <b>Save</b>.</li></ol>
Change the voice message indicator setting per line	<ol style="list-style-type: none"><li>1. Choose <b>User Options &gt; Device</b>.</li><li>2. Choose a phone from the Name drop-down menu.</li><li>3. Click <b>Line Settings</b>.</li><li>4. In the Message Waiting Lamp area, choose from various settings. <b>Note</b> Typically, the default message waiting setting prompts your phone to display a steady red light from the handset light strip to indicate a new voice message.</li><li>5. Click <b>Save</b>.</li></ol>

If you want to...	Then do this after you log in...
Change the audible voice message indicator setting per line	<ol style="list-style-type: none"> <li>1. Choose <b>User Options &gt; Device</b>.</li> <li>2. Choose a phone from the Name drop-down menu.</li> <li>3. Click <b>Line Settings</b>.</li> <li>4. In the Audible Message Waiting Indicator area, choose from various settings.</li> </ol> <p><b>Note</b> Typically, the default message waiting setting prompts your phone to display a steady red light from the handset light strip to indicate a new voice message.</p> <ol style="list-style-type: none"> <li>5. Click <b>Save</b>.</li> </ol>
Change or create a line text label that appears on your phone screen	<ol style="list-style-type: none"> <li>1. Choose <b>User Options &gt; Device</b>.</li> <li>2. Choose a phone from the Name drop-down menu.</li> <li>3. Click <b>Line Settings</b>.</li> <li>4. In the Line Text Label area, enter a text label.</li> <li>5. Click <b>Save</b>.</li> </ol> <p><b>Note</b> Your phone uses the ASCII Label field if the phone does not support double-byte character sets.</p>

## Using Cisco WebDialer

Cisco WebDialer allows you to make calls on your Cisco Unified IP Phone to directory contacts by clicking on items in a web browser. Your system administrator must configure this feature for you.

If you want to...	Then...
Use WebDialer with your User Options directory	<ol style="list-style-type: none"> <li data-bbox="341 224 1210 282">1. Log in to your User Options web pages. See <a href="#">Accessing Your User Options Web Pages, page 48</a>.</li> <li data-bbox="341 293 1085 321">2. Choose <b>User Options &gt; Directory</b> and search for a coworker.</li> <li data-bbox="341 332 848 360">3. Click the number that you want to dial.</li> <li data-bbox="341 371 1180 430">4. If this is your first time using WebDialer, set up preferences and click <b>Submit</b>. (See the last row in this table for details.)</li> <li data-bbox="341 441 1210 516">5. If the Make Call page appears, click <b>Dial</b>. (See the last row in this table to learn how to suppress this page in the future, if desired.) The call is now placed on your phone.</li> <li data-bbox="341 527 1045 591">6. To end a call, click <b>Hangup</b> or hang up from your phone.</li> </ol>
Use WebDialer with another online corporate directory (not your User Options directory)	<ol style="list-style-type: none"> <li data-bbox="341 602 1139 660">1. Log in to a WebDialer-enabled corporate directory and search for coworkers.</li> <li data-bbox="341 672 848 699">2. Click the number that you want to dial.</li> <li data-bbox="341 711 973 738">3. When prompted, enter your user ID and password.</li> <li data-bbox="341 750 1180 808">4. If this is your first time using WebDialer, set up preferences and click <b>Submit</b>. (See the last row in this table for details.)</li> <li data-bbox="341 820 1210 894">5. If the Make Call page appears, click <b>Dial</b>. (See the last row in this table to learn how to suppress this page in the future, if desired.) The call is now placed on your phone.</li> <li data-bbox="341 906 1045 969">6. To end a call, click <b>Hangup</b> or hang up from your phone.</li> </ol>



If you want to...	Then...
Log out of WebDialer	Click the logout icon in the Make Call or Hang Up page.
Set up, view, or change WebDialer preferences	<p data-bbox="391 232 713 264">Access the Preferences page.</p> <p data-bbox="391 272 1257 337">The Preferences page appears the first time that you use WebDialer (after you click the number that you want to dial.)</p> <p data-bbox="391 345 1224 410">To return to Preferences in the future, click the preferences icon from the Make Call or Hang Up page.</p> <p data-bbox="391 418 991 451">The Preferences page contains the following options:</p> <ul data-bbox="404 459 1257 912" style="list-style-type: none"> <li data-bbox="404 459 1186 524">• Preferred language—Determines the language used for WebDialer settings and prompts.</li> <li data-bbox="404 532 1257 719">• Use permanent device—Identifies the Cisco Unified IP Phone and directory number (line) that you will use to place WebDialer calls. If you have one phone with a single line, the appropriate phone and line are automatically selected. Otherwise, choose a phone and/or line. Phones are specified by host name. (To display the host name on your phone, press  and choose <b>Settings &gt; Network Configuration &gt; Host Name.</b>)</li> <li data-bbox="404 727 1257 816">• Use Extension Mobility—If selected, prompts WebDialer to use the Cisco <b>Unified</b> IP Phone that is associated with your Extension Mobility profile (if available).</li> <li data-bbox="404 824 1257 912">• Do not display call confirmation—If selected, prompts WebDialer to suppress the Make Call page. This page appears by default after you click a phone number in a WebDialer-enabled online directory.</li> </ul>

## Setting Up Phones and Access Lists for Mobile Connect

When using Cisco Mobile Connect, you must add your cellular and other phones that you want to use to make and receive calls using the same directory numbers as your desk phone. These phones are called *remote destinations*. You can also define access lists to restrict or allow calls from certain numbers to be sent to your cellular phone.

If you want to...	Then do this after you log in...
Create an access list	<ol style="list-style-type: none"> <li>1. Choose <b>User Options &gt; Mobility Settings &gt; Access Lists</b>.</li> <li>2. Click <b>Add New</b>.</li> <li>3. Enter the following information: <ul style="list-style-type: none"> <li>– Name—Identifies the access list.</li> <li>– Description—Describes the access list.</li> </ul> </li> <li>4. Choose one of these options: <ul style="list-style-type: none"> <li>– Blocked Access List—Creates list for numbers to be blocked</li> <li>– Allowed Access List—Creates list for numbers that will be permitted</li> </ul> </li> <li>5. Click <b>Save</b>.</li> </ol>
Add members to an access list.	<ol style="list-style-type: none"> <li>1. Create an access list.</li> <li>2. Click <b>Add Member</b> to add phone numbers or filters to the list.</li> <li>3. Select an option from the Filter Mask drop-down list box. You can filter a directory number, calls with restricted caller ID (Not Available), or calls with anonymous caller ID (Private).</li> <li>4. If you select a directory number from the Filter Mask drop-down list box, enter a phone number or filter in the DN Mask field. You can use the following wild cards to define a filter: <ul style="list-style-type: none"> <li>– X (upper or lower case)—Matches a single digit. For example, 408555123X matches any number between 4085551230 and 4085551239.</li> <li>– !—Matches any number of digits. For example, 408! matches any number starts with 408.</li> <li>– #—Used as a single digit for exact match.</li> </ul> </li> <li>5. To add this member to the access list, click <b>Save</b>.</li> <li>6. To save the access list, click <b>Save</b>.</li> </ol>

If you want to...	Then do this after you log in...
Add a new remote destination	<ol style="list-style-type: none"> <li>1. Choose <b>User Options &gt; Mobility Settings &gt; Remote Destinations</b>.</li> <li>2. Select the device from the Name drop-down list box.</li> <li>3. Click <b>Remote Destinations</b>.</li> <li>4. Click <b>Add New</b>.</li> <li>5. Enter the following information: <ul style="list-style-type: none"> <li>– Name—Enter a name for the cellular (or other) phone.</li> <li>– Destination Number—Enter your cellular phone number.</li> <li>– Answer Too Soon Timer—Enter the amount of time before you can pick up a call on the remote destination (in milliseconds).</li> <li>– Answer Too Late Timer—Enter the amount of time after which it is too late to pick up a call on the remote destination (in milliseconds).</li> <li>– Delay Before Ringing Timer—Enter the amount of time before the call rings on the remote destination (in milliseconds).</li> <li>– Remote Destination Profile—Select a remote destination profile, which contains the settings that apply to all of your remote destinations.</li> <li>– Allowed Access List—Select a phone number or rule that allows your cellular phone to ring when a call comes in to your desktop phone. You can select an allowed access list or blocked access list, but not both.</li> <li>– Blocked Access List—Select a phone number or rule for which your cellular phone does not ring when a call comes in to your desktop phone. You can select an allowed access list or blocked access list, but not both.</li> <li>– Mobile Phone—Select to allow your cellular phone to accept a call sent from your desktop phone.</li> <li>– Enable Mobile Connect—Select to allow your cellular phone to ring simultaneously with your desktop phone.</li> <li>– Smart Client Installed—Select to indicate that the remote destination you are setting up is a smartphone.</li> </ul> </li> <li>6. Click <b>Save</b>.</li> </ol>

# Understanding Additional Configuration Options

Your system administrator can configure your phone to use specific button and softkey templates along with special services and features, if appropriate. This table provides an overview of some configuration options that you might want to discuss with your phone system administrator based on your calling needs or work environment.



**Note** You can locate Phone Guides and other documents listed in this table on the web:  
[http://www.cisco.com/en/US/products/hw/phones/ps379/tsd\\_products\\_support\\_series\\_home.htm](http://www.cisco.com/en/US/products/hw/phones/ps379/tsd_products_support_series_home.htm)

If you...	Then...	For more information...
Need to handle more calls on your phone line	Ask your system administrator to configure your line to support more calls.	Talk to your system administrator or phone support team.
Work with (or work as) an administrative assistant	Consider using a shared line.	See <a href="#">Using a Shared Line</a> , page 28.
Want to use one extension for several phones	Request a shared line. This allows you to use one extension for your desk phone and lab phone, for example.	See <a href="#">Using a Shared Line</a> , page 28.
Share phones or office space with coworkers	Consider using: <ul style="list-style-type: none"><li>• Call Park to store and retrieve calls without using the transfer feature.</li><li>• Call Pickup to answer calls ringing on another phone.</li><li>• A shared line to view or join co-workers' calls.</li><li>• Cisco Extension Mobility to apply your phone number and user profile to a shared Cisco Unified IP Phone.</li></ul>	Ask your system administrator about these features and see: <ul style="list-style-type: none"><li>• <a href="#">Advanced Call Handling</a>, page 25.</li><li>• <a href="#">Using a Shared Line</a>, page 28.</li><li>• <a href="#">Using Cisco Extension Mobility</a>, page 33.</li></ul>
Want to temporarily apply your phone number and settings to a shared Cisco Unified IP Phone	Ask your system administrator about the Cisco Extension Mobility service.	See <a href="#">Using Cisco Extension Mobility</a> , page 33.

# Troubleshooting Your Phone

This section provides troubleshooting information for your Cisco Unified IP Phone.





## General Troubleshooting

This section provides information to help you troubleshoot general problems with your phone. For more information, see your system administrator.

Symptom	Explanation
You cannot hear a dial tone or complete a call	One or more of the following factors might apply: <ul style="list-style-type: none"> <li>You must log into the Extension Mobility service.</li> <li>You must enter a client matter code (CMC) or forced authorization code (FAC) after dialing a number. (SCCP phones only.)</li> <li>Your phone has time-of-day restrictions that prevent you from using some features during certain hours of the day.</li> </ul>
The softkey that you want to use does not appear	One or more of the following factors might apply: <ul style="list-style-type: none"> <li>You must press <b>more</b> to reveal additional softkeys.</li> <li>You must change the line state (for example, go off-hook or have a connected call).</li> <li>Your phone is not configured to support the feature associated with that softkey.</li> </ul>
<b>Join</b> fails (SCCP phones only)	<b>Join</b> requires multiple selected calls. Be sure that you have selected at least one call in addition to the active call, which is selected automatically.
<b>Barge</b> fails and results in a fast busy tone	You cannot barge an encrypted call if the phone you are using is not configured for encryption. When your barge attempt fails for this reason, your phone plays a fast busy tone.
You are disconnected from a call that you joined using <b>Barge</b>	You will be disconnected from a call that you have joined using <b>Barge</b> if the call is put on hold, transferred, or turned into a conference call.
Cisco <b>CallBack</b> fails	The other party might have call forwarding enabled.

## Viewing Phone Administration Data

Your system administrator might ask you to access administration data on your phone for troubleshooting purposes.

<b>If you are asked to...</b>	<b>Then...</b>
Access network configuration data	Press  and choose <b>Settings &gt; Network Configuration</b> and select the network configuration item that you want to view.
Access status data	Press  and choose <b>Settings &gt; Status</b> and select the status item that you want to view.
Access phone model information	Press  and choose <b>Settings &gt; Model Information</b> .
Access phone call and voice quality information	Press  and choose <b>Settings &gt; Status &gt; Call Statistics</b> .

## Using the Quality Reporting Tool

Your system administrator may temporarily configure your phone with the Quality Reporting Tool (QRT) to troubleshoot performance problems. You can press **QRT** to submit information to your system administrator. Depending on configuration, use the QRT to:

- Immediately report an audio problem on a current call
- Select a general problem from a list of categories and choose reason codes

# Cisco One-Year Limited Hardware Warranty Terms

---

There are special terms applicable to your hardware warranty and various services that you can use during the warranty period. Your formal Warranty Statement, including the warranties and license agreements applicable to Cisco software, is available on Cisco.com. Follow these steps to access and download the *Cisco Information Packet* and your warranty and license agreements from Cisco.com.

1. Launch your browser, and go to this URL:  
[http://www.cisco.com/univercd/cc/td/doc/es\\_inpkc/cetrans.htm](http://www.cisco.com/univercd/cc/td/doc/es_inpkc/cetrans.htm)  
The Warranties and License Agreements page appears.
2. To read the *Cisco Information Packet*, follow these steps:
  - a. Click the **Information Packet Number** field, and make sure that the part number 78-5235-03A0 is highlighted.
  - b. Select the language in which you would like to read the document.
  - c. Click **Go**.
  - d. The Cisco Limited Warranty and Software License page from the Information Packet appears.
  - e. Read the document online, or click the **PDF** icon to download and print the document in Adobe Portable Document Format (PDF).



---

**Note**

You must have Adobe Acrobat Reader to view and print PDF files. You can download the reader from the Adobe website: <http://www.adobe.com>

---

3. To read translated and localized warranty information about your product, follow these steps:
  - a. Enter this part number in the Warranty Document Number field:  
78-10747-01C0
  - b. Select the language in which you would like to view the document.
  - c. Click **Go**.  
The Cisco warranty page appears.
  - d. Read the document online, or click the **PDF** icon to download and print the document in Adobe Portable Document Format (PDF).

You can also contact the Cisco service and support website for assistance:

[http://www.cisco.com/public/Support\\_root.shtml](http://www.cisco.com/public/Support_root.shtml).

## Duration of Hardware Warranty

One (1) Year

## **Replacement, Repair, or Refund Policy for Hardware**

Cisco or its service center will use commercially reasonable efforts to ship a replacement part within ten (10) working days after receipt of a Return Materials Authorization (RMA) request. Actual delivery times can vary, depending on the customer location.

Cisco reserves the right to refund the purchase price as its exclusive warranty remedy.

## **To Receive a Return Materials Authorization (RMA) Number**

Contact the company from whom you purchased the product. If you purchased the product directly from Cisco, contact your Cisco Sales and Service Representative.

Complete the information below, and keep it for reference.

Company product purchased from	
Company telephone number	
Product model number	
Product serial number	
Maintenance contract number	



# Index

---

## A

Abbreviated Dialing [13, 25](#)  
Address Book Synchronization Tool [51](#)  
answering calls [14](#)  
Applications Menu button [9](#)  
Applications menus, using [10](#)  
ASCII label field support [51](#)  
authenticated calls [30](#)  
Auto Dial [12](#)  
AutoAnswer [14](#)

## B

barge  
    and privacy [30](#)  
    and shared lines [28](#)  
    using [29](#)  
buttons, identifying [8](#)

## C

call forwarding [20](#)  
    configuring on phone [20](#)  
call logs  
    dialing from [12](#)  
    erasing [41](#)  
    viewing and dialing from [41](#)

call park [15, 27](#)  
call pickup [15, 26](#)  
call waiting [14](#)  
CallBack [13](#)  
caller ID [9](#)  
call-handling  
    advanced [25](#)  
    basic [12](#)  
calls  
    answering [14](#)  
    compared to lines [10](#)  
    conference features for [21](#)  
    ending [15](#)  
    forwarding [20](#)  
    handling multiple [14](#)  
    holding and resuming [16](#)  
    icons for [10](#)  
    maximum per line [10](#)  
    monitoring [36](#)  
    multiple parties on [21](#)  
    multiple, switching between [17](#)  
    parking [27](#)  
    placing [12, 13](#)  
    prevent barging of [30](#)  
    prioritizing [32](#)  
    redirecting while ringing [14, 26](#)  
    reporting problems with [62](#)

- secure [30](#)
- storing and retrieving [27](#)
- transferring [18](#)
- using Join with [22](#)
- viewing [9, 17](#)
- cBarge
  - using [29](#)
  - See also barge
- Cisco Extension Mobility feature, using [14](#)
- Cisco Unified IP Phone
  - connecting [4](#)
  - documentation for [2](#)
  - feature configuration for [11](#)
  - illustration [8](#)
  - protocol [11](#)
  - registering [6](#)
  - SCCP [11](#)
  - securing handset rest [6](#)
  - SIP [11](#)
  - troubleshooting [61](#)
  - web-based services for [52](#)
- Cisco WebDialer [55](#)
- Client Matter Code
  - See CMC
- CMC [61](#)
- conference
  - joining [23](#)
  - levels of security [30](#)
  - secure [23, 30](#)
- conference calls
  - Meet-Me [22, 24](#)
  - standard [21, 22](#)
- corporate directory

- dialing from [13](#)
- dialing from web page [13](#)
- using on phone [43](#)

## D

- Details softkey, viewing multiparty calls with [42](#)
- device configuration page [48](#)
- dialing options
  - additional [13](#)
  - basic [12](#)
- dialing, options for [12, 13](#)
- directory
  - corporate [43](#)
  - dialing from [13](#)
  - personal [44](#)
  - using from web page [55](#)
  - using on phone [41](#)
- DND [20](#)
- Do Not Disturb (DND) [20](#)
- documentation, accessing [2](#)

## E

- encrypted calls [30](#)
- ending a call, options [15](#)
- Extension Mobility
  - EM [33](#)
- external devices, using [2](#)

## F

- FAC [61](#)

Fast Dials  
    configuring from web page [45](#)  
    using on phone [44](#)  
features, availability of [11](#)  
Forced Authorization Code  
    See FAC  
forwarding calls, options for [20](#)

## **G**

group call pickup [26](#)  
Group Listen [36](#)

## **H**

handset  
    light strip [9](#)  
    securing in cradle [6](#)  
    using [36, 37](#)  
hands-free listening [36](#)  
hanging up, options for [15](#)  
headset  
    connecting [6](#)  
    performance [7](#)  
help, using [11](#)  
hold  
    and switching calls [17](#)  
    and transferring [18](#)  
    using [16](#)  
hold button illustration [9](#)  
hold reversion [16](#)  
hold reversion indicators [16](#)  
hunt groups

    description [27](#)  
    log out of [28](#)

## **I**

icons, for call states [10](#)  
installing, Cisco Unified IP Phone [4](#)

## **J**

Join, using [21](#)

## **K**

keypad description [9](#)

## **L**

language (locale) settings [53](#)  
lines  
    compared to calls [10](#)  
    description [10](#)  
    description of [10](#)  
    number of calls supported on [10, 60](#)  
    shared [28](#)  
logging out of hunt groups [28](#)

## **M**

Malicious Call Identification  
    See MCID  
MCID [31](#)  
Meet-Me conferences [22, 24](#)

- menus, using [10](#)
- messages
  - indicator for [39](#)
  - listening to [47](#)
- missed calls, records of [41](#)
- MLPP, using [32](#)
- monitoring a call [36](#)
- multiparty calls
  - identifying in call logs [42](#)
  - viewing details of [42](#)
- multiple calls, handling [14, 17](#)

## **N**

- navigation button illustration [9](#)

## **O**

- off-hook dialing [12](#)
- on-hook dialing [12](#)

## **P**

- PAB
  - dialing from [13](#)
  - using from web page [49](#)
  - using on phone [44](#)
- parking a call [15](#)
- password, changing [53](#)
- Personal Address Book
  - See PAB
- Personal Directory
  - using from web page [49](#)

- using on phone [44](#)
- phone lines, description of [10](#)
- phone services
  - configuring [49](#)
  - See also User Options web pages
- PIN, changing [53](#)
- placed calls, records of [41](#)
- placing a call [12](#)
- placing calls, options for [12, 13](#)
- pre-dial [12](#)
- prioritizing calls [32](#)
- privacy
  - and shared lines [28](#)
  - using [30](#)

## **Q**

- QRT [62](#)
- Quality Reporting Tool [62](#)

## **R**

- received calls, records of [41](#)
- redial [12](#)
- remote-in-use icon for shared lines [28](#)
- resuming held calls [16](#)
- reverting calls [16](#)
- ring tones, changing [39](#)
- ringer
  - customizing [39](#)
  - indicator for [9](#)
  - volume for [39](#)

## S

- safety warnings [2](#)
- SCCP (Skinny Call Control Protocol) [11](#)
- secure calls [30](#)
- secure conference
  - starting [23](#)
  - verifying [23](#)
- security, for calls [30](#)
- services, subscribing to [52](#)
- settings, customizing [39](#)
- shared lines
  - and remote-in-use icon [28](#)
  - description of [28](#)
  - with barge [29](#)
  - with privacy [30](#)
- signaling protocol [11](#)
- SIP (Session Initiation Protocol) [11](#)
- softkey buttons, description of [9](#)
- sound quality [7](#)
- speaker
  - answering calls with [14](#)
  - using [15](#)
- speaker, using [36](#)
- speed dial
  - configuring [25](#)
  - description of [25](#)
  - labels [51](#)
  - using [13](#)
- subscriptions, for phone services [52](#)
- suspicious calls, tracing [31](#)
- switching calls [17](#)

## T

- TABSynch [51](#)
- TAPS [6](#)
- Tool for Auto-Registered Phones Support [6](#)
- transferring, options for [18](#)
- troubleshooting
  - general [61](#)
  - QRT [62](#)

## U

- User Options web pages
  - accessing [48](#)
  - configuring features and services with [49](#)
  - subscribing to phone services with [52](#)
- using a headset [6](#)

## V

- voice message indicator
  - description of [47](#)
- voice messages, accessing [47](#)
- volume
  - for handset, headset, or speaker [36, 37](#)
  - for phone ringer [39](#)
- volume button illustration [9](#)

## W

- warnings, safety [2](#)
- web-based services
  - configuring [49](#)
  - See also User Options web pages







**Americas Headquarters**  
Cisco Systems, Inc.  
170 West Tasman Drive  
San Jose, CA 95134-1706  
USA  
www.cisco.com  
Tel: 408 526-4000  
800 553-NETS (6387)  
Fax: 408 527-0883

**Asia Pacific Headquarters**  
Cisco Systems, Inc.  
168 Robinson Road  
#28-01 Capital Tower  
Singapore 068912  
www.cisco.com  
Tel: +65 6317 7777  
Fax: +65 6317 7799

**Europe Headquarters**  
Cisco Systems International  
BV  
Haarlerbergpark  
Haarlerbergweg 13-19  
1101 CH Amsterdam  
The Netherlands  
www-europe.cisco.com  
Tel: 31 0 800 020 0791  
Fax: 31 0 20 357 1100

**Cisco has more than 200 offices worldwide. Addresses, phone numbers, and fax numbers are listed on the  
Cisco Website at [www.cisco.com/go/offices](http://www.cisco.com/go/offices).**

CCVP, the Cisco Logo, and the Cisco Square Bridge logo are trademarks of Cisco Systems, Inc.; Changing the Way We Work, Live, Play, and Learn is a service mark of Cisco Systems, Inc.; and Access Registrar, Aironet, BPX, Catalyst, CCDA, CCDP, CCIE, CCIP, CCNA, CCNP, CCSP, Cisco, the Cisco Certified Internetwork Expert logo, Cisco IOS, Cisco Press, Cisco Systems, Cisco Systems Capital, the Cisco Systems logo, Cisco Unity, Enterprise/Solver, EtherChannel, EtherFast, EtherSwitch, Fast Step, Follow Me Browsing, FormShare, GigaDrive, HomeLink, Internet Quotient, IOS, iPhone, IP/TV, iQ Expertise, the iQ logo, iQ Net Readiness Scorecard, iQuick Study, LightStream, Linksys, MeetingPlace, MGX, Networking Academy, Network Registrar, *Packet*, PIX, ProConnect, RateMUX, ScriptShare, SlideCast, SMARTnet, StackWise, The Fastest Way to Increase Your Internet Quotient, and TransPath are registered trademarks of Cisco Systems, Inc. and/or its affiliates in the United States and certain other countries.

All other trademarks mentioned in this document or Website are the property of their respective owners. The use of the word partner does not imply a partnership relationship between Cisco and any other company. (0704R)

© 2007 Cisco Systems, Inc. All rights reserved.



The Java logo is a trademark or registered trademark of Sun Microsystems, Inc. in the U.S. or other countries.